

0 600 828 171

Stand } 01-07-07  
Issue }

**Fig./Abb. 1**

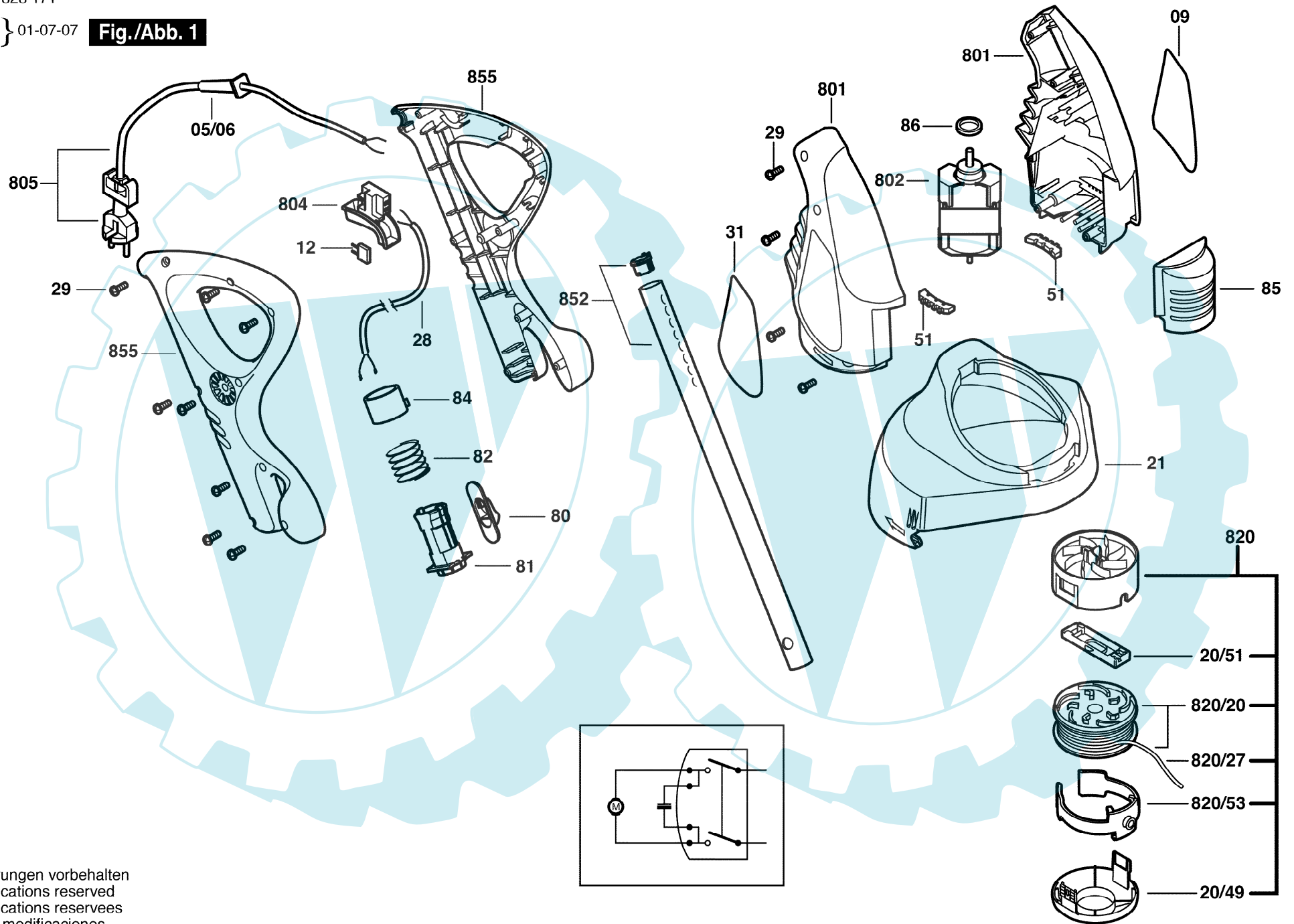

Änderungen vorbehalten  
Modifications reserved  
Modifications reserves  
Salvo modificaciones