

0 600 827 403

Stand } ~~00-03~~
Issue } 00-06-13

Fig./Abb. 1

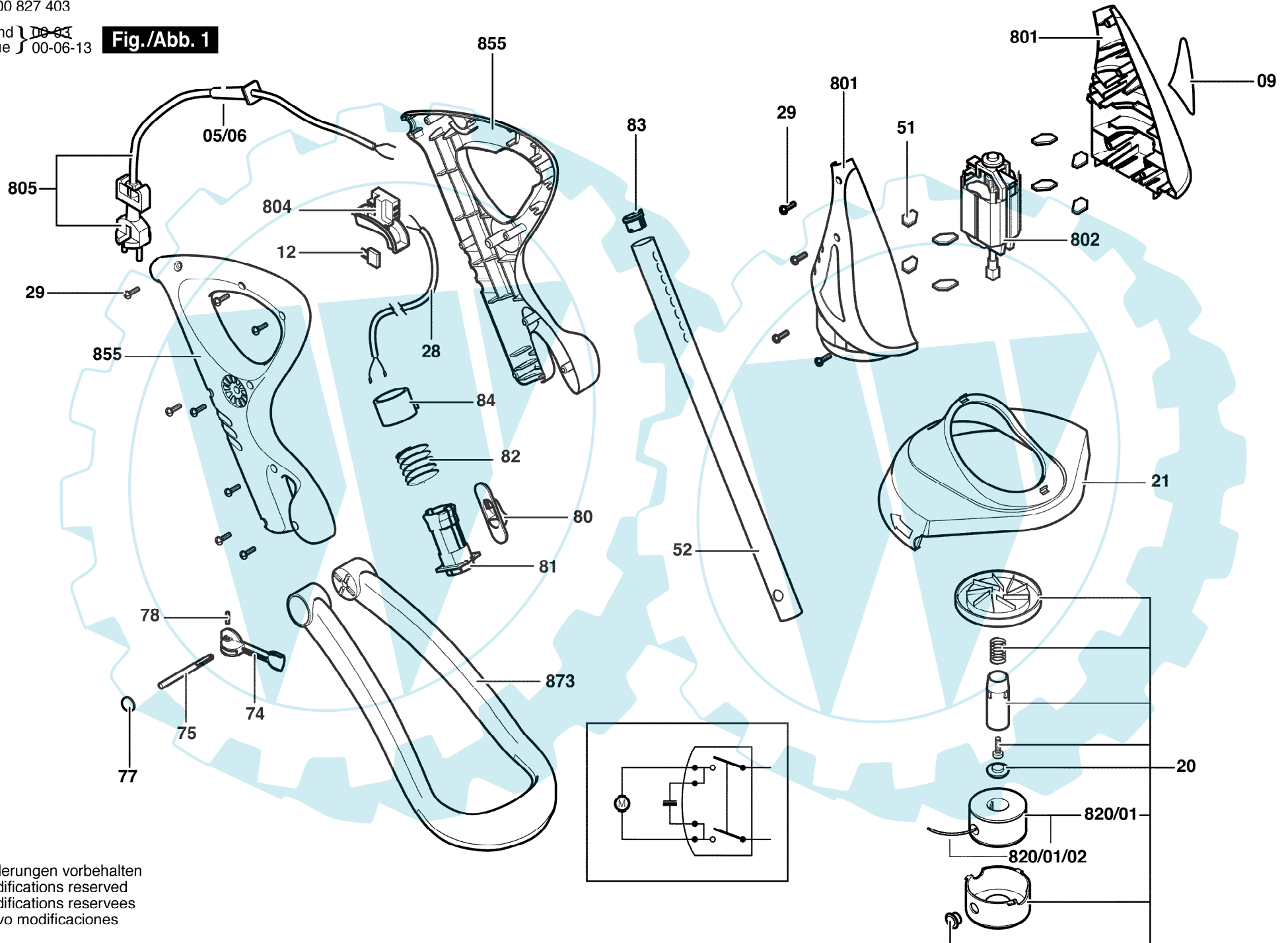

Änderungen vorbehalten
Modifications reserved
Modifications reserves
Salvo modificaciones