

0 600 827 003

Stand } ~~99-01~~  
Issue } 00-03-31

**Fig./Abb. 1**

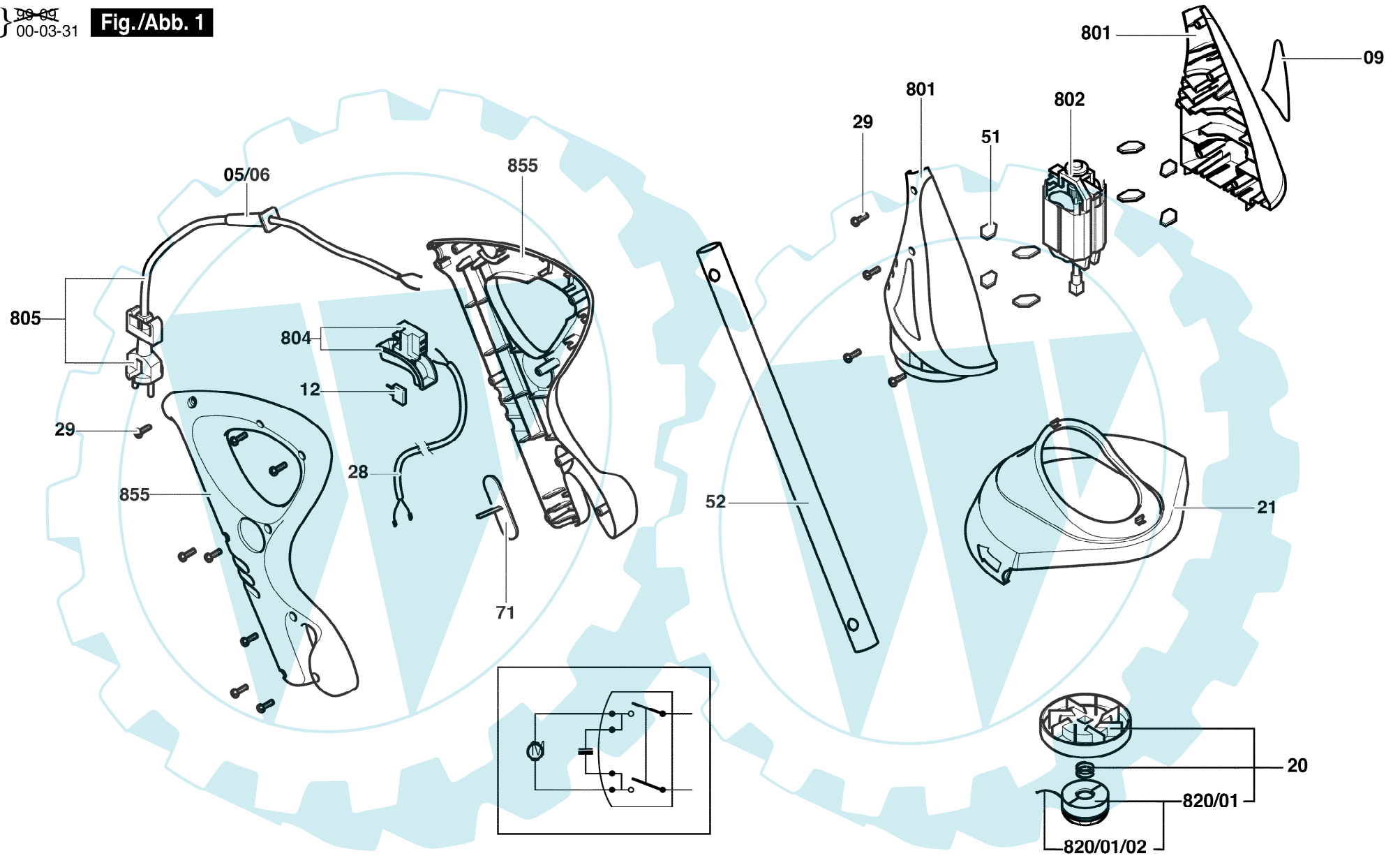

Änderungen vorbehalten  
Modifications reserved  
Modifications reserves  
Salvo modificaciones