

Ersatzteilliste
(5.958-984.0) ETL K 49XM

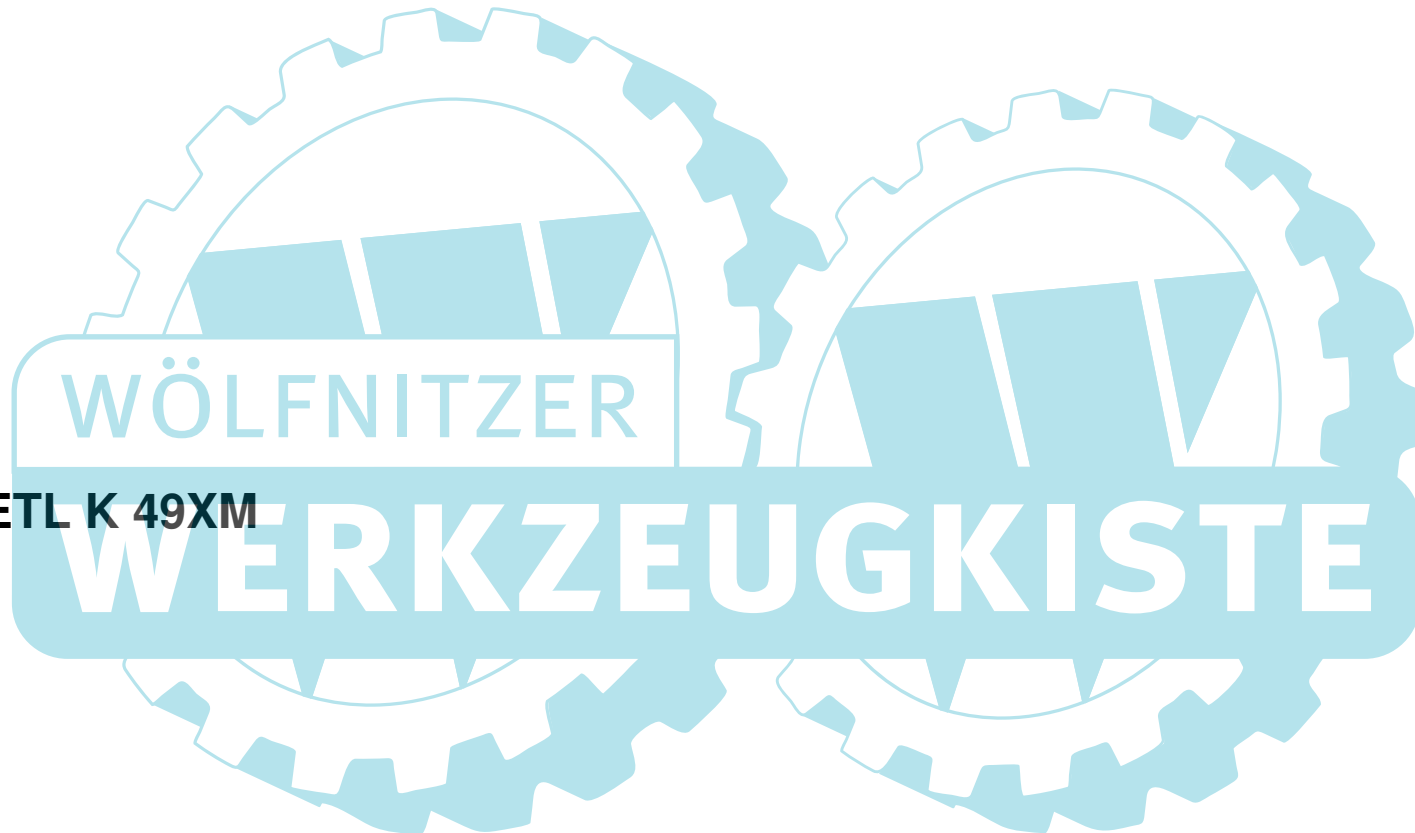

DE HINWEISE

Weitere Sprachen:

Diese Ersatzteilliste ist in weiteren Sprachen erhältlich. Sie erhalten diese unter www.kaercher.com im Bereich Service. Die Schreibweise der Teilenummer, z.B. 75456380, entspricht der Teilenummer 7.545-638.0.

Mengenangaben:

Die Mengenangaben in der Ersatzteilliste entsprechen den in der Baugruppe verbauten Stückzahlen der Bauteile.

Meterware:

Ersatzteile welche als Meterware geliefert werden sind auf Einbaulänge selbst zu kürzen. Die Stückzahlen sind als Mindestbestellmenge =1m angegeben und müssen je nach Bedarf auf weitere volle Meterzahlen erhöht werden.

Versionen/ Werknummern:

Sind Versionen oder Werknummern in der Ersatzteilliste angegeben, ist anhand dieser vor Bestellung zu prüfen, welches Bauteil für ihr Gerät verwendet werden muss.

Lackierte Teile:

Bei Bestellungen von lackierten Teilen welche in der Ersatzteilliste nicht in verschiedenen Farben ausgewiesen sind, ist zusätzlich die Farbnummer oder Farbe mit anzugeben.

Technische Änderungen:

Technische Änderungen sowie das Recht der ausschließlichen Auswertung unseres geistigen Eigentums behalten wir uns vor.

EN INSTRUCTIONS

Other languages:

This list of spare parts is also available in other languages. You can get this list from www.kaercher.com in the Service division. The designation of the part number e.g. 75456380 is equal to 7.545-638.0.

Quantity details:

The quantity details in the spare parts list correspond to the number of pieces of the component installed in the assembly group.

Piece goods:

Spare parts that are sold as piece goods are to be cut to the desired length. The quantities have been indicated as minimum order quantity =1m and must be rounded off to the full meter figure depending on your requirements.

Version/ Plant numbers:

If version or plant numbers are mentioned in the spare parts list, then use the same to check before ordering which spare part needs to be used for your appliance.

Painted parts:

While ordering painted parts that are not mentioned in the spare parts list in their colour variations, please mention the colour number or the colour you require.

Technical changes:

We reserve the right to make technical changes as well as the right to exclusive use of our intellectual property.

FR REMARQUES

Autres langues:

Cette liste de pièces de rechange est disponible en autres langues. Cela est disponible sous www.kaercher.com dans le menu Service. La désignation du numéro de pièce, par ex. 75456380, correspond au numéro de pièce 7.545-638.0.

Indications de quantité:

Les indications de quantité dans la liste de pièces de rechange correspondre aux nombres de pièces des composant utilisées dans la construction.

Matériel au mètre:

Les pièces de rechange qui sont livrées au mètre doivent être raccourcies à longueur souhaitée par l'acheteur même. Les nombres des pièces sont indiquées en quantité de commande minimale = 1m et doivent être augmentés selon le besoin à une chiffre de mètre complète.

Versions/ Numéros d'usine:

Lorsqu'il sont indiquées des versions ou des numéros d'usine dans la liste de pièces de rechange, vous devez vérifier que composant doit être utilisé pour votre appareil.

Pièces laquées:

Pour commander des pièces laquées, où les différentes couleurs ne sont pas indiquées dans la liste des pièces de rechange, vous devez indiquer en plus le numéro de la couleur ou seulement la couleur.

Modifications techniques:

Nous nous réservons la possibilité des modifications techniques ainsi le droit d'exploitation exclusive de notre propriété intellectuelle.

IT AVVERTENZE

Altre lingue:

Il presente elenco di parti di ricambio è disponibile sul nostro sito Web anche in altre lingue: sotto www.kaercher.com alla voce "Service".
L'indicazione del codice pezzo, ad es. 75456380, corrisponde al codice pezzo 7.545-638.0

Indicazioni di quantità:

Le indicazioni di quantità riportate dall'elenco "parti di ricambio" corrispondono al numero delle singole componenti contenute nella rispettiva unità.

Merce a metro:

Le parti di ricambio fornite come "merce a metro" devono venire in seguito accorciate alla lunghezza necessaria per il montaggio. La quantità unitaria è indicata come "quantità minima di ordinazione = 1m" e deve all'occorrenza venire moltiplicata per il numero intero di metri necessari.

Versioni / Numeri di fabbricazione:

Quando l'elenco "parti di ricambio" riporta diverse versioni o numeri di fabbricazione, confrontare la versione o il numero di fabbricazione del ricambio desiderato con quelle/i presenti nell'elenco e indicarla/o al momento dell'ordinazione.

Parti di ricambio verniciate:

Nel caso di ricambi verniciati, se l'elenco parti di ricambio non ne riporta espressamente i diversi colori, al momento dell'ordinazione è necessario indicare anche il colore o il numero del colore desiderato.

Modifiche tecniche:

Ci riserviamo il diritto di apportare modifiche tecniche così come il diritto di utilizzo esclusivo della nostra proprietà intellettuale.

ES INDICACIONES

Otros idiomas:

La lista de piezas de repuesto se puede adquirir en otros idiomas. La puede adquirir en www.kaercher.com en el área de servicios.
La notación de los números de las piezas, p.ej. 75456380 corresponde al número de pieza 7.545-638.0.

Cantidades:

Las indicaciones de cantidades de la lista de piezas de repuesto corresponden al número de piezas montadas en el componente.

Mercancía por metros:

Las piezas de repuesto que se suministran por metros se pueden cortar al largo deseado. La unidad mínima de pedido es de = 1 m y el número de metros completos se puede aumentar según necesidad.

Versiones/números de fábrica:

Si se indica la versión o número de fábrica en la lista de piezas de repuesto, se debe comprobar en ella la pieza a usar para su aparato antes de realizar el pedido.

Piezas lacadas:

Al realizar pedidos de piezas lacadas que no estén indicadas en los diferentes colores en la lista de piezas de repuesto, se debe indicar también la referencia del color o el color.

Modificaciones técnicas:

Reservados los derechos de realizar modificaciones técnicas y aprovechar nuestra propiedad intelectual.

PL WSKAZÓWKI

Pozostałe języki:

Ta lista części zamiennych jest dostępna w także w innych językach. Mogą ją Państwo pobrać ze strony www.kaercher.com w dziale Serwis.
Sposób zapisywania numeru części, np. 75456380, odpowiada numerowi części 7.545-638.0.

Dane ilości:

Dane ilości podane w liście części zamiennych odpowiadają liczbie sztuk podzespołów tworzących dany moduł.

Towar sprzedawany na metry:

Części zamienne dostarczane jako towar sprzedawany na metry po zamontowaniu należy samodzielnie skrócić do potrzebnej długości. Liczba sztuk podana jest jako minimalna ilość zamówienia = 1m i w zależności od potrzeb zwiększa się ją o kolejne pełne metry.

Wersje/ Numer zakładu:

Jeżeli w liście części zamiennych podane są wersje lub numery zakładu, przed zamówieniem na ich podstawie należy sprawdzić, który podzespół stosuje się w Państwa urządzeniu.

Części lakierowane:

W przypadku zamówień części lakierowanych, które w liście części zamiennych nie podano w wielu kolorach, należy dodatkowo zaznaczyć nr koloru lub kolor.

Zmiany techniczne:

Zastrzegamy sobie prawo do zmian technicznych oraz wyłącznego wykorzystywania naszej własności intelektualnej.

RU УКАЗАНИЯ:

Другие языки:

Данный список запасных частей также доступен на других языках. Вы найдете его на сайте www.kaercher.com в разделе Service
Маркировка номера детали, например, 75456380, соответствует номеру детали 7.545-638.0.

Указание количества:

Количественные данные в списке запасных частей соответствуют числу компонентов, входящих в состав узлов.

Товар, продаваемый на метры:

Запасные части, продающиеся на метры, необходимо обрезать до нужной длины. Число изделий указано в виде минимального объема заказа = 1м и их количество можно округлить до требуемого по мере необходимости.

Варианты исполнения/заводские номера:

Если варианты исполнения или заводские номера указаны в списке запасных частей, то перед заказом необходимо проверить, какая деталь подходит для вашего устройства.

Лакированные детали:

При заказе лакированных деталей, варианты расцветки которых не указаны в списке запасных частей, необходимо дополнительно указать номер цвета или необходимый для вас цвет.

Технические изменения:

Мы оставляем за собой право на технические изменения, а также право на исключительное использование нашей интеллектуальной собственности.



ETL K 49XM (5.958-984.0)	6
10 Einzelteile (0.102-920.0).....	7
20 Pumpensatz (0.108-224.0).....	9
21 Steuergehaeuse (0.108-225.0).....	10
22 Geradschubfuehrung (0.108-226.0).....	12
23 Steuergehaeuse (0.108-610.0).....	14
24 Geradschubfuehrung (0.108-611.0).....	16
30 Motor (0.112-933.0).....	18
31 Motor (0.112-764.0).....	19
32 Motor (0.112-934.0).....	21
40 Zubehoer (0.148-423.0).....	23
41 Handspritzpistole (0.148-424.0).....	24
3 Ersatzteilsatz O-Ring 5x (2.880-296.0).....	26
42 Handspritzpistole (0.148-539.0).....	27
6 Ersatzteilsatz O-Ring 5x (2.880-296.0).....	29
100 Ersatzteilsatz Pistole V3 (2.883-945.0).....	30
43 Handspritzpistole (0.105-822.0).....	31
3 Ersatzteilsatz O-Ring 5x (2.880-296.0).....	33
44 Strahlrohr (0.148-425.0).....	34
45 Flaechenreiniger (0.103-424.0).....	36
46 Flaechenreiniger (0.110-230.0).....	38
47 Flaechenreiniger (0.148-928.0).....	40
50 E-Kasten (0.127-197.0).....	42
51 E-Kasten (0.127-126.0).....	43
52 E-Kasten (0.127-198.0).....	45

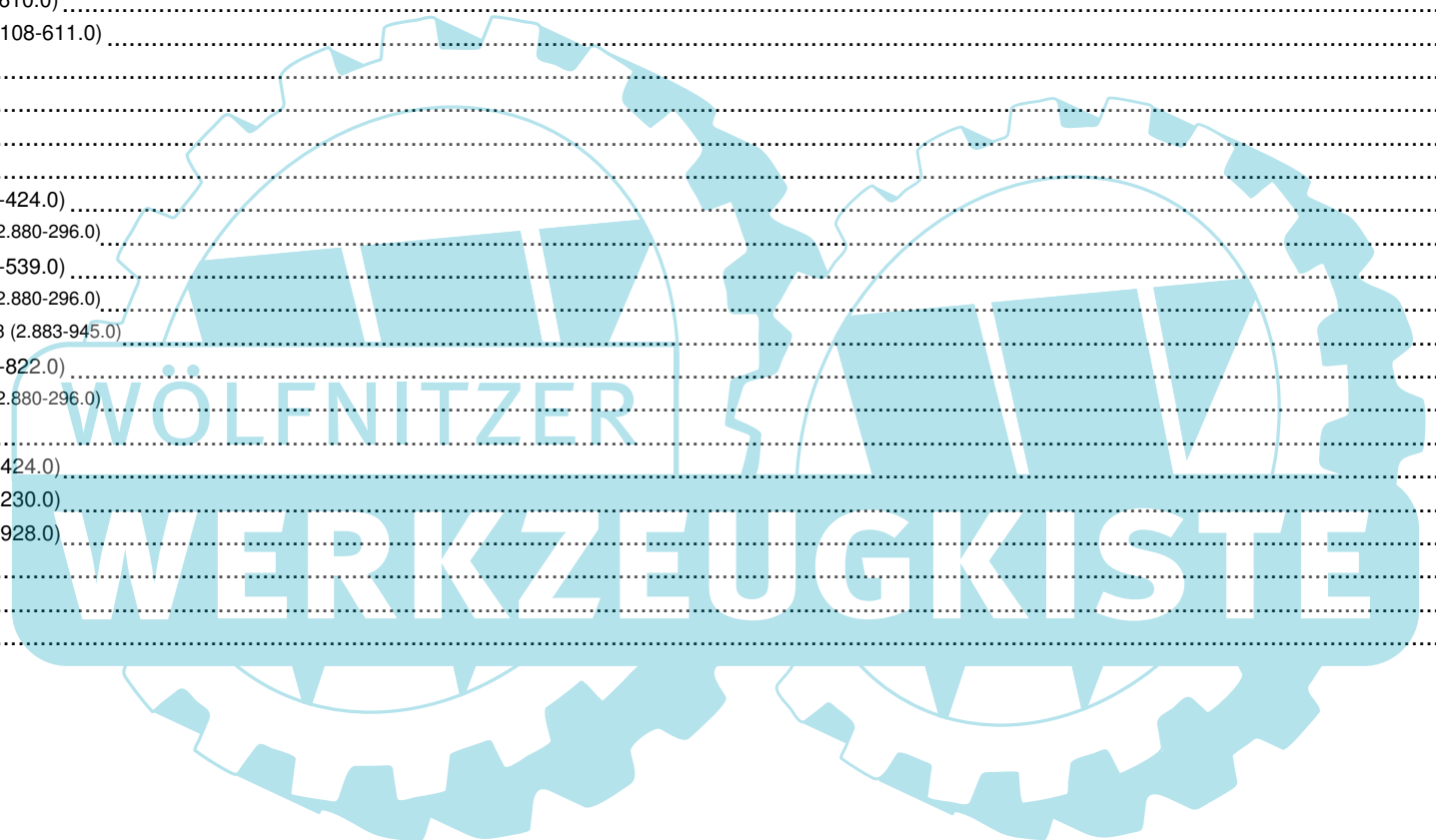

Pos	Materialnr.	Benennung	ab WK Nr.	bis WK.Nr.
10	0.102-920.0	Einzelteile	0000000000	0000000000
20	0.108-224.0	Pumpensatz	0000000000	0000000000
30	0.112-933.0	Motor	0000000000	0000000000
40	0.148-423.0	Zubehoer	0000000000	0000000000
50	0.127-197.0	E-Kasten	0000000000	0000000000



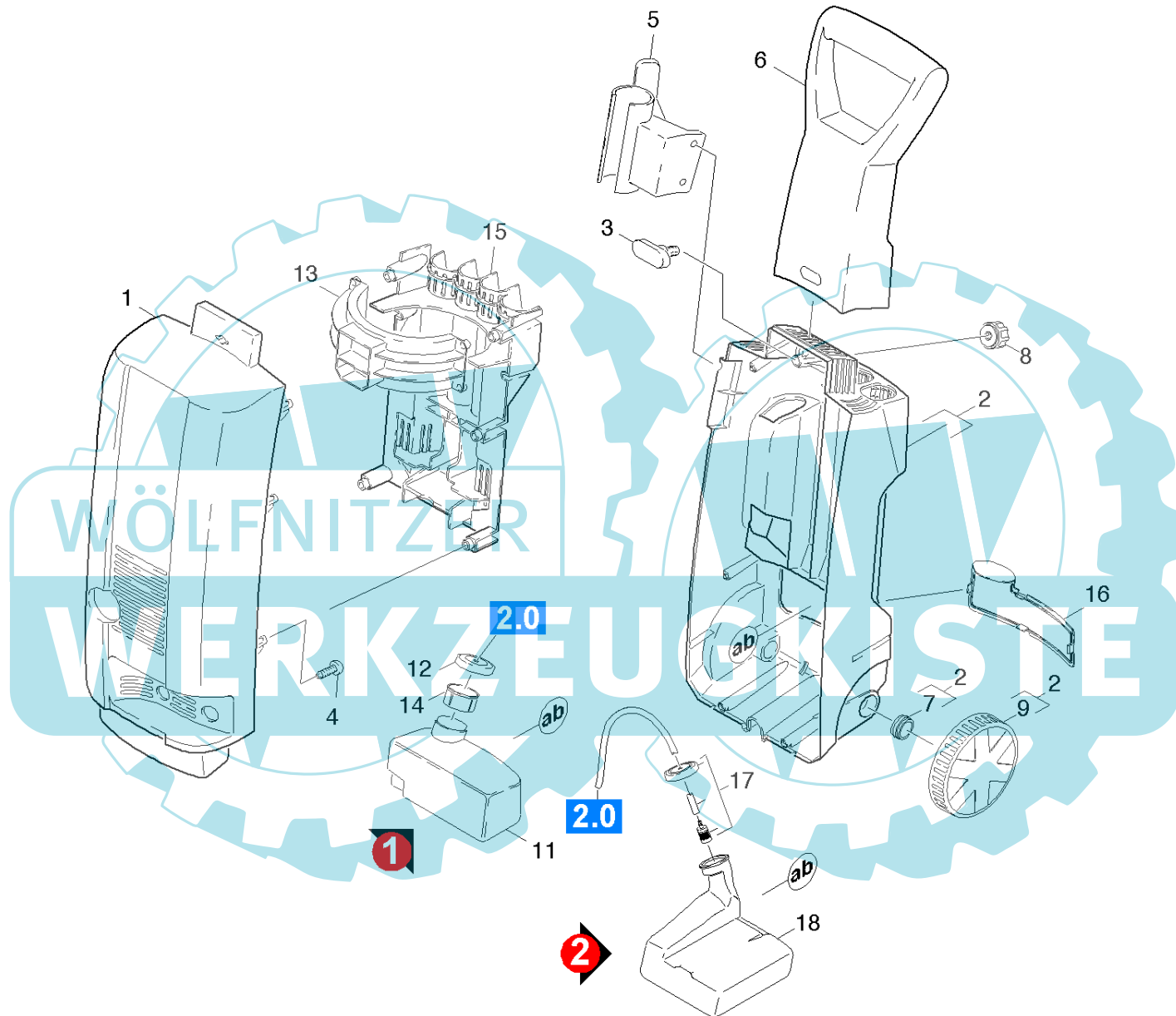

ET/VT Pos	Materialnr.	Benennung	Menge	ME	ab WK Nr.	bis WK.Nr.	Var. Information	Fußnotentext	Preis (EUR)
1	9.037-016.0	Haube	1.000	ST	0000000000	0000000000	K 4.99M		26,70
Positionstext: 1.636-680.0 /-681.0									
1	9.036-808.0	Haube Kaercher K3.97 SK II	1.000	ST	0000000000	0000000000	K 4.97M		43,60
Positionstext: / 1.423-356.0 / -358.0 / -359.0 / -361.0 / 1.636-582.0									
2	9.012-509.0	Chassis kpl. K3.9x	1.000	ST	0000000000	0000000000		FUER VERSIONEN OHNE TANK	25,70
2	9.011-857.0	Chassis kpl. K3.9XMD	1.000	ST	0000000000	0000000000		FUER TANK VERSION 2	26,50
2	7.777-999.0	Bevorratung eingestellt	1.000	ST	0000000000	0000000000		FUER TANK VERSION 1	a.A.
3	9.036-737.0	Schraube Befestigung Griff K39X	1.000	ST	0000000000	0000000000			2,20
X	4	9.086-173.0	Schraube Hi-Lo d.4x22 Torx-d.7,5	8.000	ST	0000000000	0000000000		0,50
X	5	9.037-038.0	Halter Zubehoer neu	1.000	ST	0000000000	0000000000		2,80
6	9.036-724.0	Handgriff K39X	1.000	ST	0000000000	0000000000			11,90
7	9.036-727.0	Stopfen	2.000	ST	0000000000	0000000000			1,40
8	9.036-738.0	Drehknopf K39X	1.000	ST	0000000000	0000000000			2,20
9	9.036-726.0	Rad	2.000	ST	0000000000	0000000000			a.A.
11	9.036-728.0	Tank RM K 39X	1.000	ST	0000000000	0000000000	VERSION 1		a.A.
12	9.048-067.0	Tankdeckel K 39X	1.000	ST	0000000000	0000000000	VERSION 1		2,40
13	9.037-365.0	Flansch Halterung KX.68	1.000	ST	0000000000	0000000000			4,50
14	9.036-729.0	Filter RM K 39XM	1.000	ST	0000000000	0000000000	VERSION 1		1,50
15	9.036-722.0	Formteil	1.000	ST	0000000000	0000000000			9,40
16	9.036-730.0	Abdeckung Tank RM	1.000	ST	0000000000	0000000000			2,70
17	9.011-711.0	Filter RM kpl.	1.000	ST	0000000000	0000000000	VERSION 2		5,30
18	9.036-893.0	Tank RM K3./4.9XMD	1.000	ST	0000000000	0000000000	VERSION 2		8,50

Pos	Materialnr.	Benennung	Menge	ME	ab WK Nr.	bis WK.Nr.	Var. Information	Preis (EUR)
21	0.108-225.0	Steuergehaeuse	1.000	ST	0000000000	0000299999	Version 1	a.A.
22	0.108-226.0	Geradschubfuehrung	1.000	ST	0000000000	0000299999	Version 1	a.A.
23	0.108-610.0	Steuergehaeuse	1.000	ST	0000300000	0000000000	Version 2	a.A.
24	0.108-611.0	Geradschubfuehrung	1.000	ST	0000300000	0000000000	Version 2	a.A.



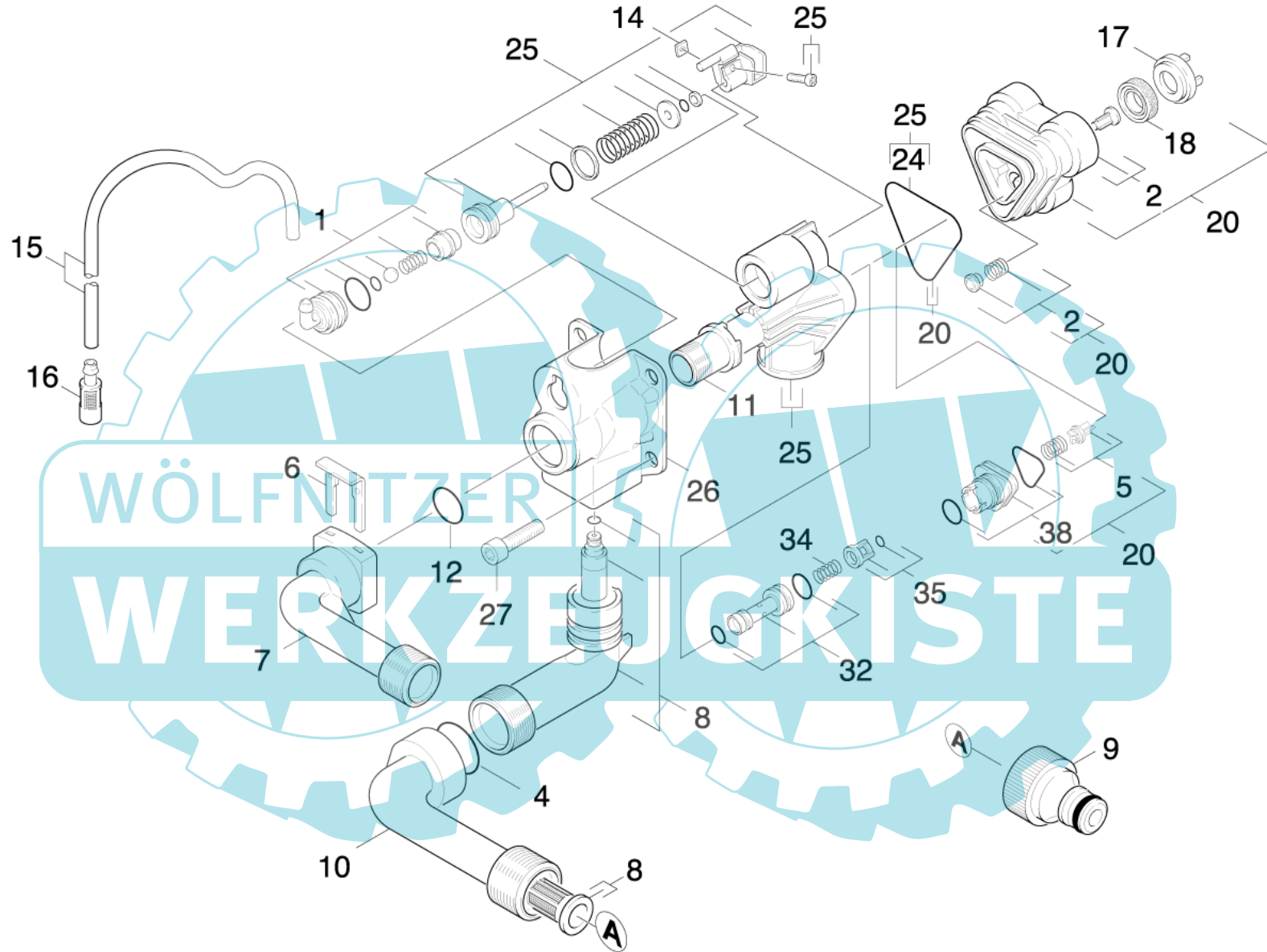

ET/VT	Pos	Materialnr.	Benennung	Menge	ME	ab WK Nr.	bis WK.Nr.	Fußnotentext	Preis (EUR)
X-X	1	9.001-741.0	Ansaugung RM fuer Ersatz	1.000	ST	0000000000	0000000000		8,50
X-X	2	9.001-110.0	Formteil kpl.	1.000	ST	0000000000	0000000000	SET BESTEHEND AUS 3X FORMTEIL KPL.	4,50
	4	9.081-420.0	O-Ring 17,86x2,62	1.000	ST	0000000000	0000000000		0,50
	5	9.001-149.0	ET-Satz Ventil	1.000	ST	0000000000	0000000000	SET BESTEHEND AUS 3X VENTIL	3,90
	6	9.039-148.0	Klammer	1.000	ST	0000000000	0000000000		1,40
X-X	7	9.036-703.0	Anschluss Druckseite	1.000	ST	0000000000	0000000000		3,90
X-X	8	9.001-187.0	Ersatzteilsatz	1.000	ST	0000000000	0000000000		8,10
X-X	9	6.465-031.0	Anschluss 3/4	1.000	ST	0000000000	0000000000		4,30
X-X	10	9.036-801.0	Anschluss Saugseite schwarz	1.000	ST	0000000000	0000000000		3,90
X-X	11	9.036-444.0	Huelse	1.000	ST	0000000000	0000000000		3,10
X-X	12	6.362-151.0	O-Ring 10 x 2 NBR 70	1.000	ST	0000000000	0000000000		0,20
	14	7.311-569.0	4kt-Mutter M4 -04-A2E DIN 562	1.000	ST	0000000000	0000000000		0,20
	15	6.388-216.0	Schlauch DN 5	1.000	M	0000000000	0000000000	ALS METERWARE BESTELLEN	3,10
X	16	5.731-652.0	Filter mit Gewicht	1.000	ST	0000000000	0000000000		5,10
X	17	9.036-322.0	Stuetzscheibe	3.000	ST	0000000000	0000000000		0,60
X-X	18	6.362-875.0	Nutring	3.000	ST	0000000000	0000000000		2,60
X-X	20	9.001-105.0	ET-Satz Zylinderkopf	1.000	ST	0000000000	0000000000		13,50
X-X	24	9.081-422.0	Formdichtung	1.000	ST	0000000000	0000000000		0,30
X-X	25	9.001-104.0	ET-Satz Steuerkopf	1.000	ST	0000000000	0000000000		28,30
	26	9.039-117.0	Deckel	1.000	ST	0000000000	0000000000		6,80
	27	9.086-200.0	Schraube M 8x55 Class 8.8	4.000	ST	0000000000	0000000000		0,70
	32	9.001-108.0	Injektor kpl.	1.000	ST	0000000000	0000000000		6,90
X	34	9.047-026.0	Feder	1.000	ST	0000000000	0000000000		0,50
	35	9.001-107.0	Kaefig kpl.	1.000	ST	0000000000	0000000000		2,70
	38	9.001-106.0	Verbindungsstueck	1.000	ST	0000000000	0000000000		3,80

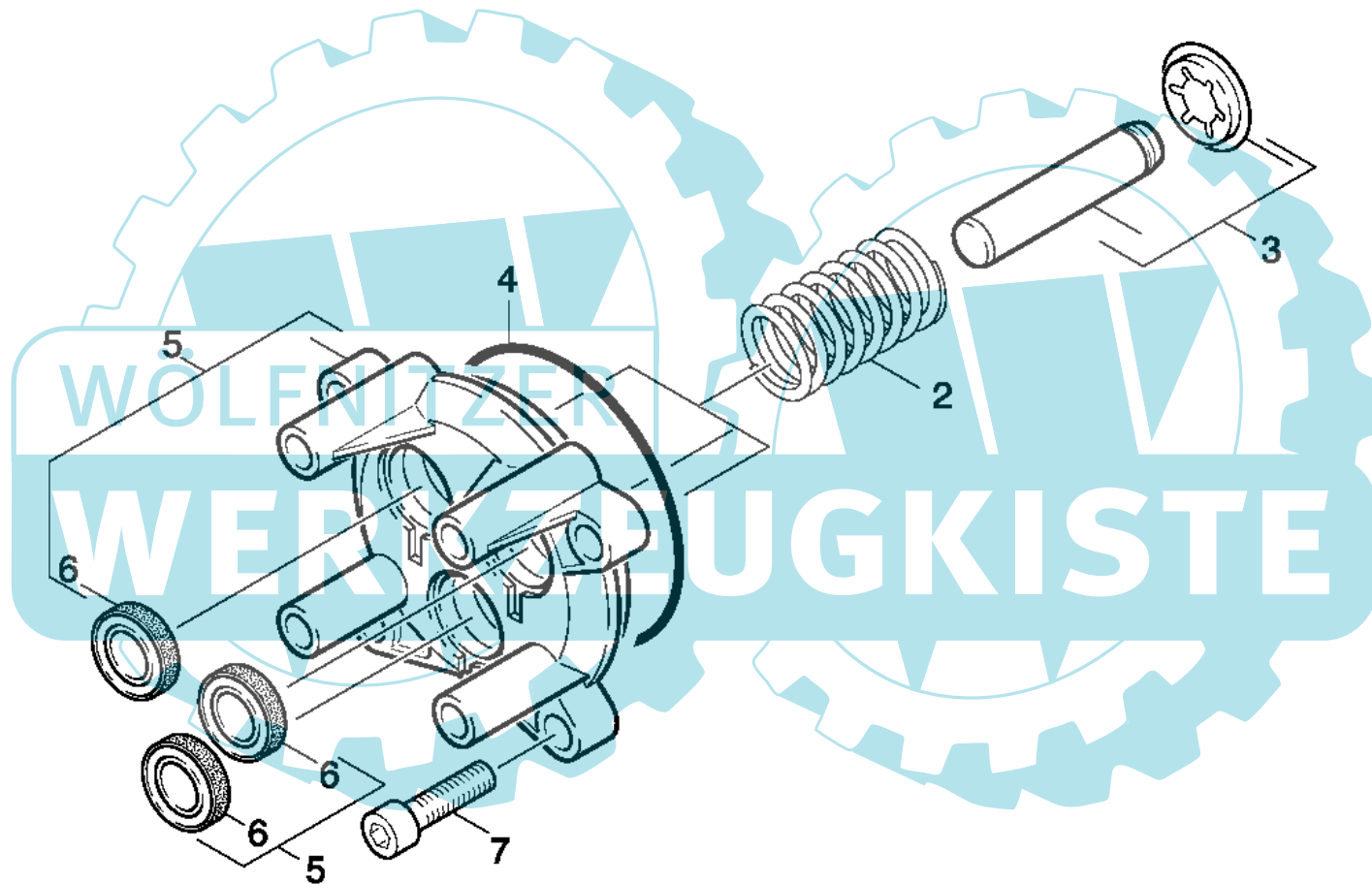

ET/VT	Pos	Materialnr.	Benennung	Menge	ME	ab WK Nr.	bis WK.Nr.	Fußnotentext	Preis (EUR)
X	2	9.047-023.0	Feder	3.000	ST	0000000000	0000000000		1,20
	3	9.001-102.0	Kolben kpl.	1.000	ST	0000000000	0000000000	SET BESTEHEND AUS 3X KOLBEN KPL.	13,60
	4	9.081-373.0	O-Ring 70x2-NBR70	1.000	ST	0000000000	0000000000		1,40
	5	9.001-101.0	Geradschubfuehrung	1.000	ST	0000000000	0000000000		16,50
X-X	6	6.964-026.0	Nutring	3.000	ST	0000000000	0000000000		2,60
X	7	7.306-042.0	Zyl.Schr. M8x25 -8.8-A2E ISO4762	4.000	ST	0000000000	0000000000		0,50

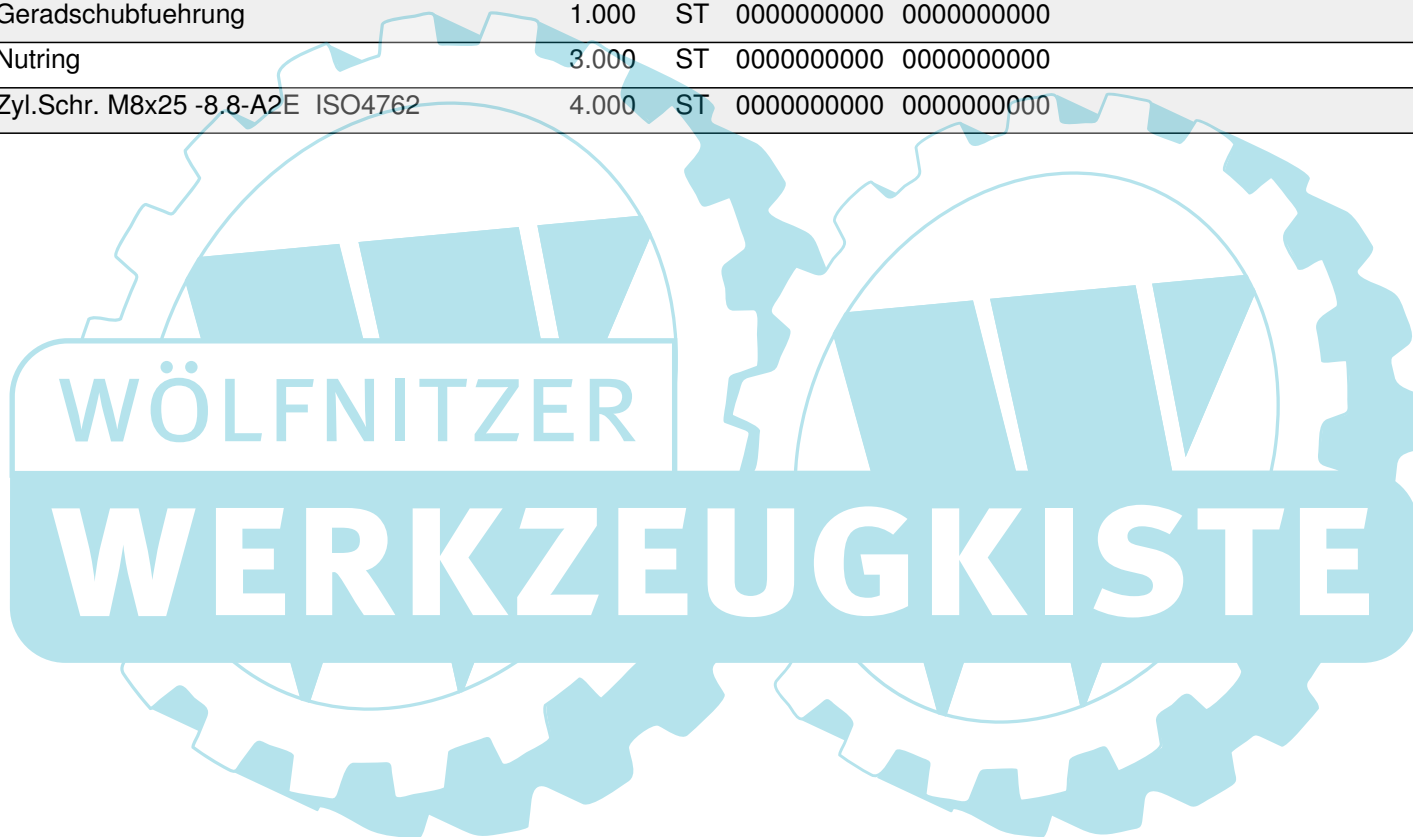

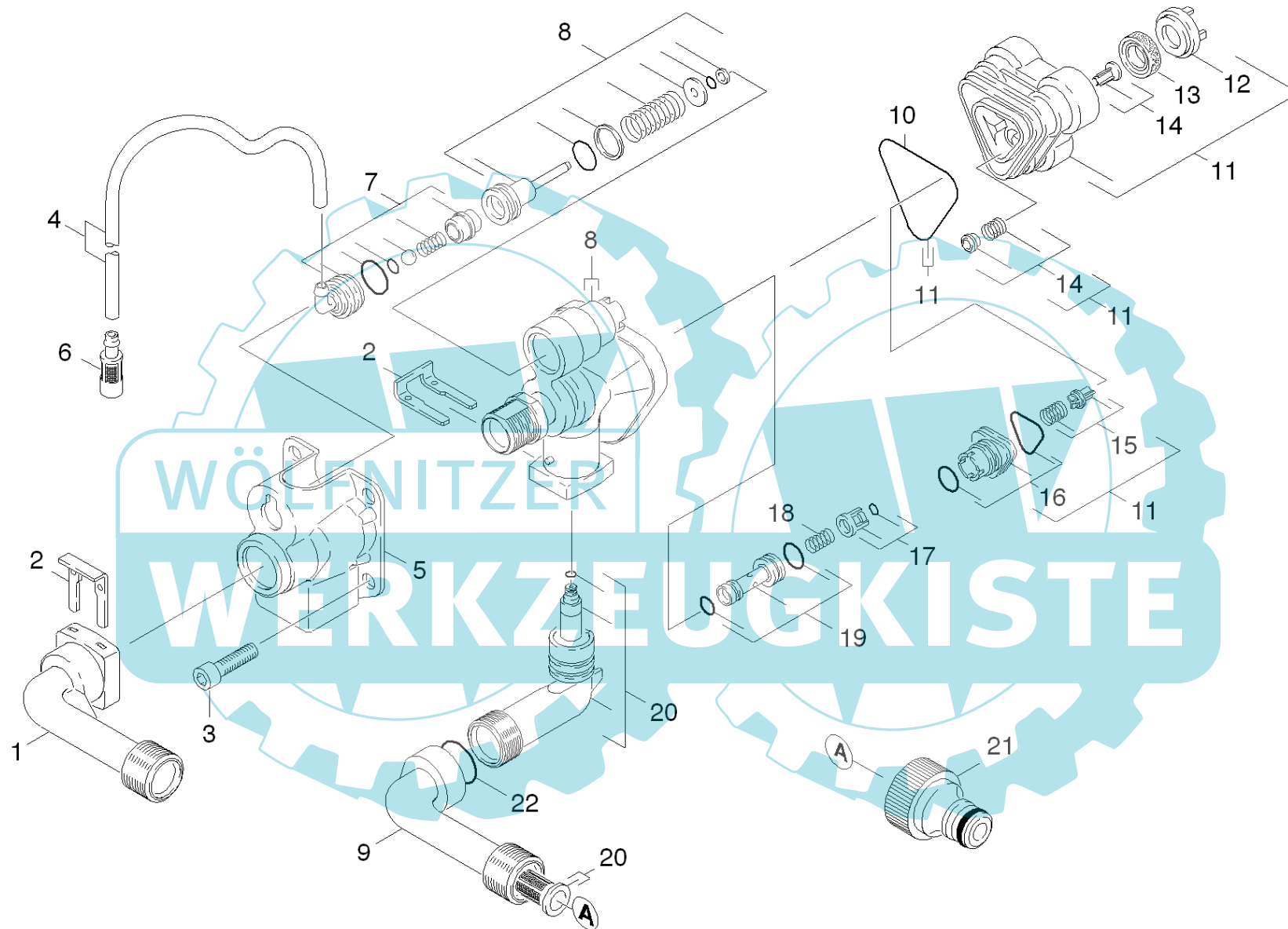

ET/VT	Pos	Materialnr.	Benennung	Menge	ME	ab WK Nr.	bis WK.Nr.	Fußnotentext	Preis (EUR)
X-X	1	9.036-703.0	Anschluss Druckseite	1.000	ST	0000000000	0000000000		3,90
	2	9.039-148.0	Klammer	2.000	ST	0000000000	0000000000		1,40
	3	9.086-200.0	Schraube M 8x55 Class 8.8	4.000	ST	0000000000	0000000000		0,70
	4	6.388-216.0	Schlauch DN 5	1.000	M	0000000000	0000000000		3,10
	5	9.039-308.0	Deckel K130	1.000	ST	0000000000	0000000000		6,70
X	6	5.731-652.0	Filter mit Gewicht	1.000	ST	0000000000	0000000000		5,10
X-X	7	9.001-741.0	Ansaugung RM fuer Ersatz	1.000	ST	0000000000	0000000000		8,50
X-X	8	9.001-361.0	ET-Satz Steuerkopf	1.000	ST	0000000000	0000000000		28,30
X-X	9	9.036-801.0	Anschluss Saugseite schwarz	1.000	ST	0000000000	0000000000		3,90
X-X	10	9.081-422.0	Formdichtung	1.000	ST	0000000000	0000000000		0,30
X-X	11	9.001-105.0	ET-Satz Zylinderkopf	1.000	ST	0000000000	0000000000		13,50
X-X	13	6.362-875.0	Nutring	3.000	ST	0000000000	0000000000		2,60
X-X	14	9.001-110.0	Formteil kpl.	1.000	ST	0000000000	0000000000	SET BESTEHEND AUS 3X FORMTEIL KPL.	4,50
	15	9.001-149.0	ET-Satz Ventil	1.000	ST	0000000000	0000000000	SET BESTEHEND AUS 3X VENTIL	3,90
	16	9.001-106.0	Verbindungsstueck	1.000	ST	0000000000	0000000000		3,80
	17	9.001-107.0	Kaefig kpl.	1.000	ST	0000000000	0000000000		2,70
X	18	9.047-026.0	Feder	1.000	ST	0000000000	0000000000		0,50
	19	9.001-108.0	Injektor kpl.	1.000	ST	0000000000	0000000000		6,90
X-X	20	9.001-375.0	ET-Satz Sauganschluss	1.000	ST	0000000000	0000000000		8,10
X-X	21	6.465-031.0	Anschluss 3/4	1.000	ST	0000000000	0000000000		4,30
	22	9.081-420.0	O-Ring 17,86x2,62	1.000	ST	0000000000	0000000000		0,50

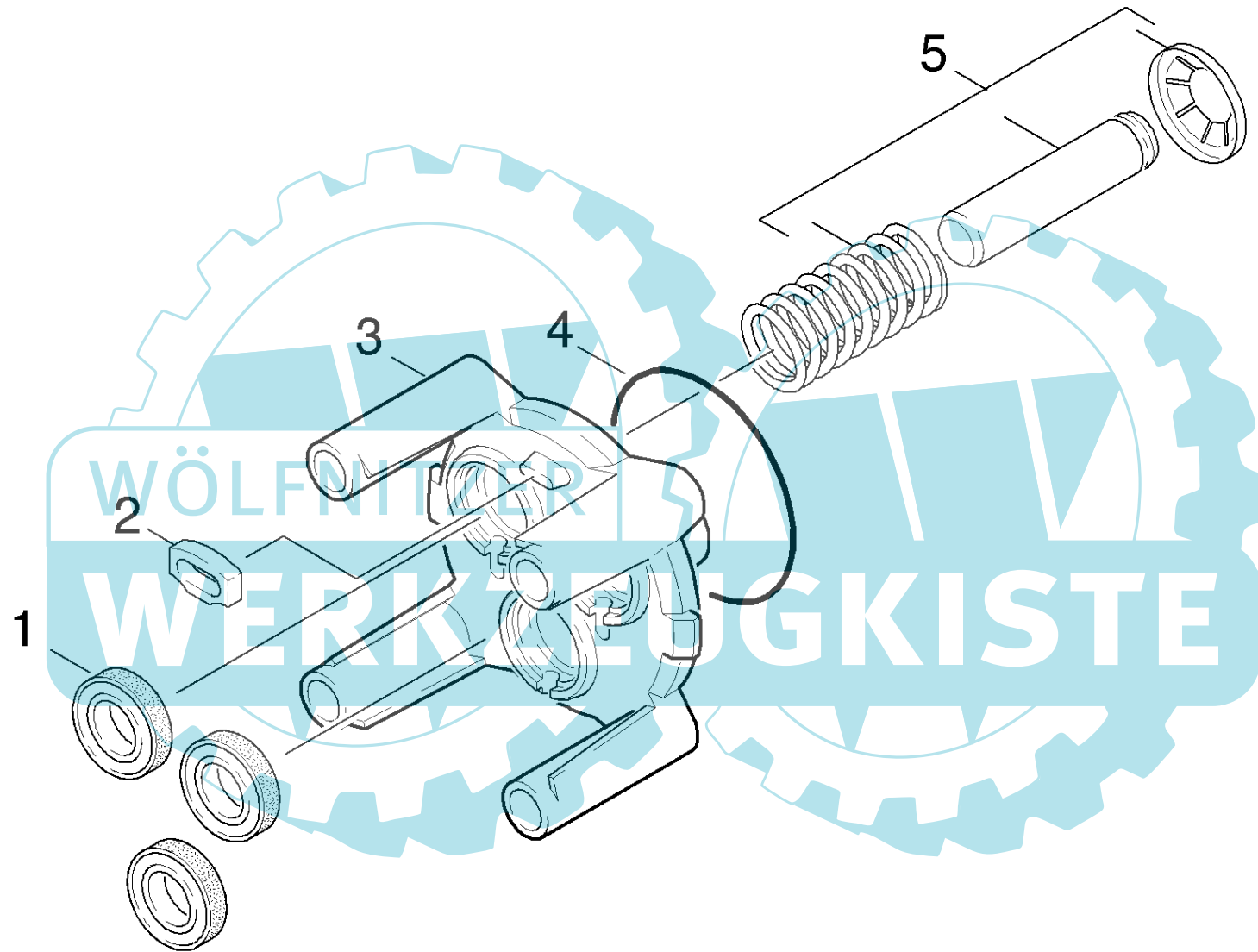

ET/VT	Pos	Materialnr.	Benennung	Menge	ME	ab WK Nr.	bis WK.Nr.	Fußnotentext	Preis (EUR)
X-X	1	6.964-026.0	Nutring	3.000	ST	0000000000	0000000000		2,60
	2	9.048-071.0	Dichtung	1.000	ST	0000000000	0000000000		0,50
	3	9.042-076.0	Geradschubfuehrung	1.000	ST	0000000000	0000000000		16,10
	4	9.080-426.0	O-Ring 62x3 NBR 70Shore	1.000	ST	0000000000	0000000000		1,40
	5	9.001-320.0	Kolben kpl.	3.000	ST	0000000000	0000000000	SET BESTEHEND AUS 3X KOLBEN KPL.	34,40



Pos	Materialnr.	Benennung	Menge	ME	ab WK Nr.	bis WK.Nr.	Var. Information	Preis (EUR)
31	0.112-764.0	Motor	1.000	ST	0000000000	0000299999	Version 1	a.A.
32	0.112-934.0	Motor	1.000	ST	0000300000	0000000000	Version 2	a.A.

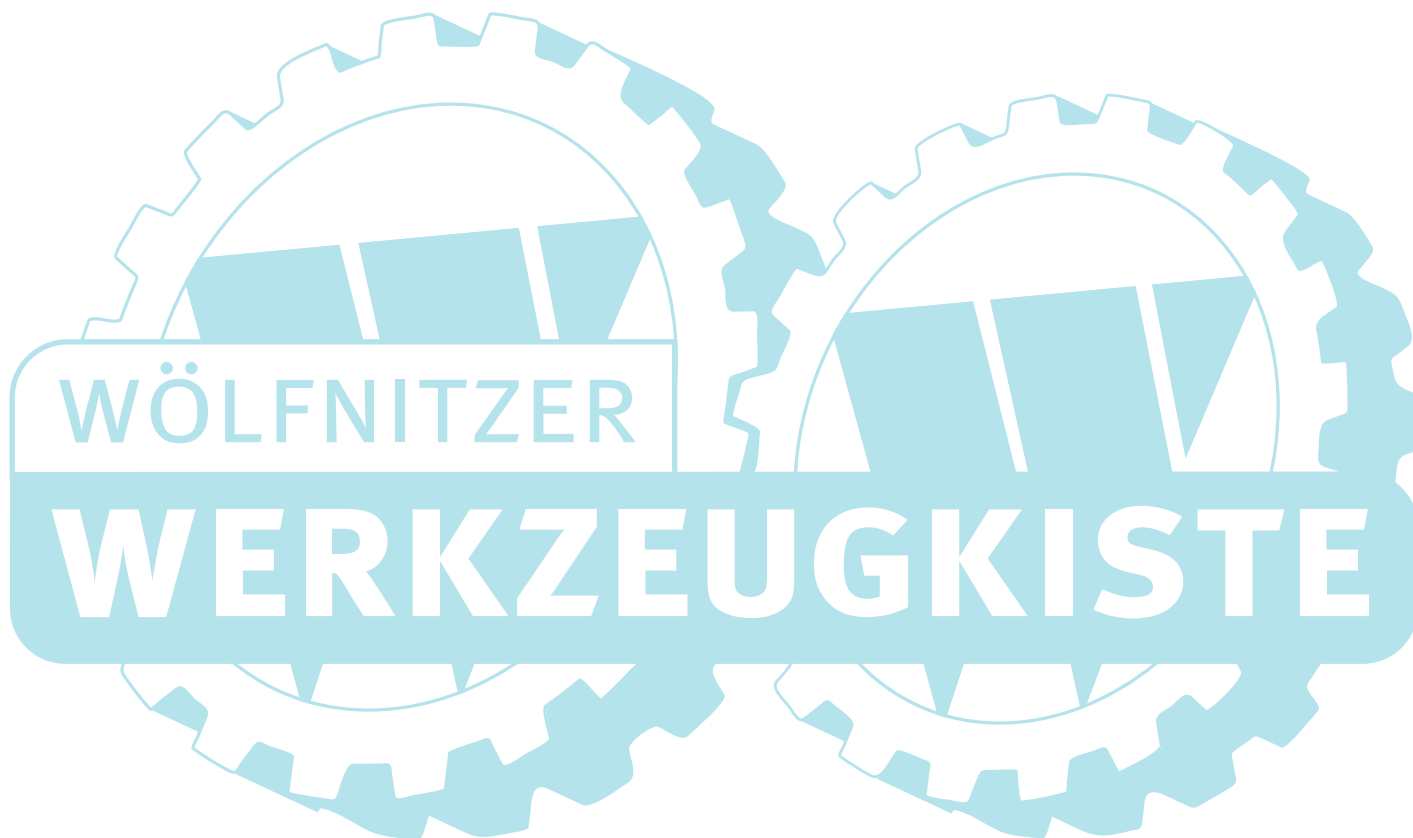

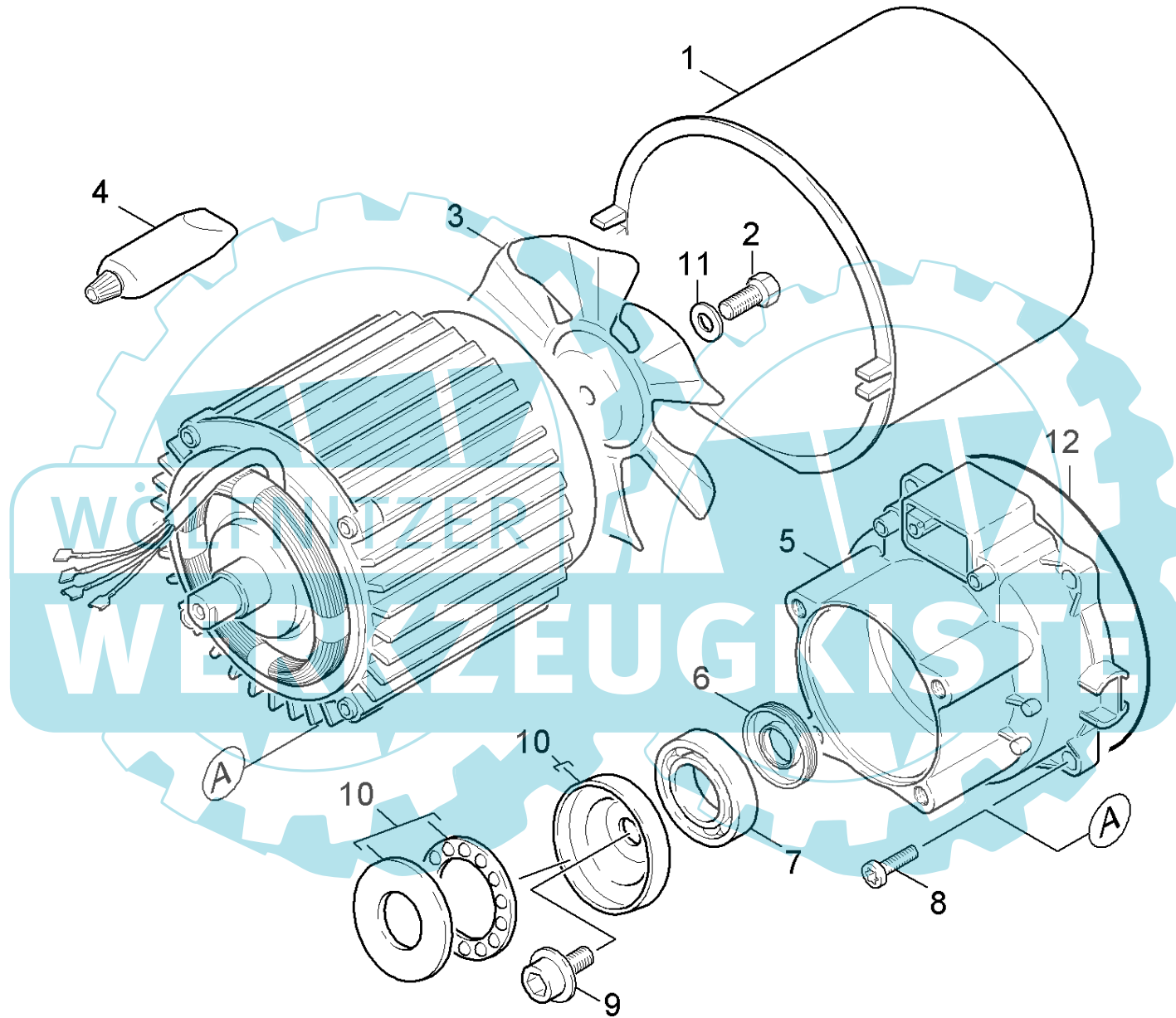

Pos	Materialnr.	Benennung	Menge	ME	ab WK Nr.	bis WK.Nr.	Preis (EUR)
1	6.964-090.0	Gehaeuse Luefter	1.000	ST	0000000000	0000000000	5,30
2	7.304-395.0	6kt-Schraube M8x16-8.8-A2E ISO 4017	1.000	ST	0000000000	0000000000	0,20
3	9.039-102.0	Luefterrad	1.000	ST	0000000000	0000000000	5,00
4	6.964-092.0	Fliessfett 50ml	1.000	ST	0000000000	0000000000	6,30
6	9.078-007.0	Wellendichtring 17x35x5	1.000	ST	0000000000	0000000000	6,70
7	7.401-010.0	Kugellager 6303 -St DIN 625	1.000	ST	0000000000	0000000000	7,50
8	9.086-185.0	Schraube M 5x20	4.000	ST	0000000000	0000000000	0,70
9	9.086-169.0	Schraube mit Scheibe M 8x16	1.000	ST	0000000000	0000000000	0,70
10	9.001-289.0	Taumelscheibe	1.000	ST	0000000000	0000000000	76,70
11	7.312-233.0	Faecherscheibe A8,4-FSt-A3E DIN6798	1.000	ST	0000000000	0000000000	0,10

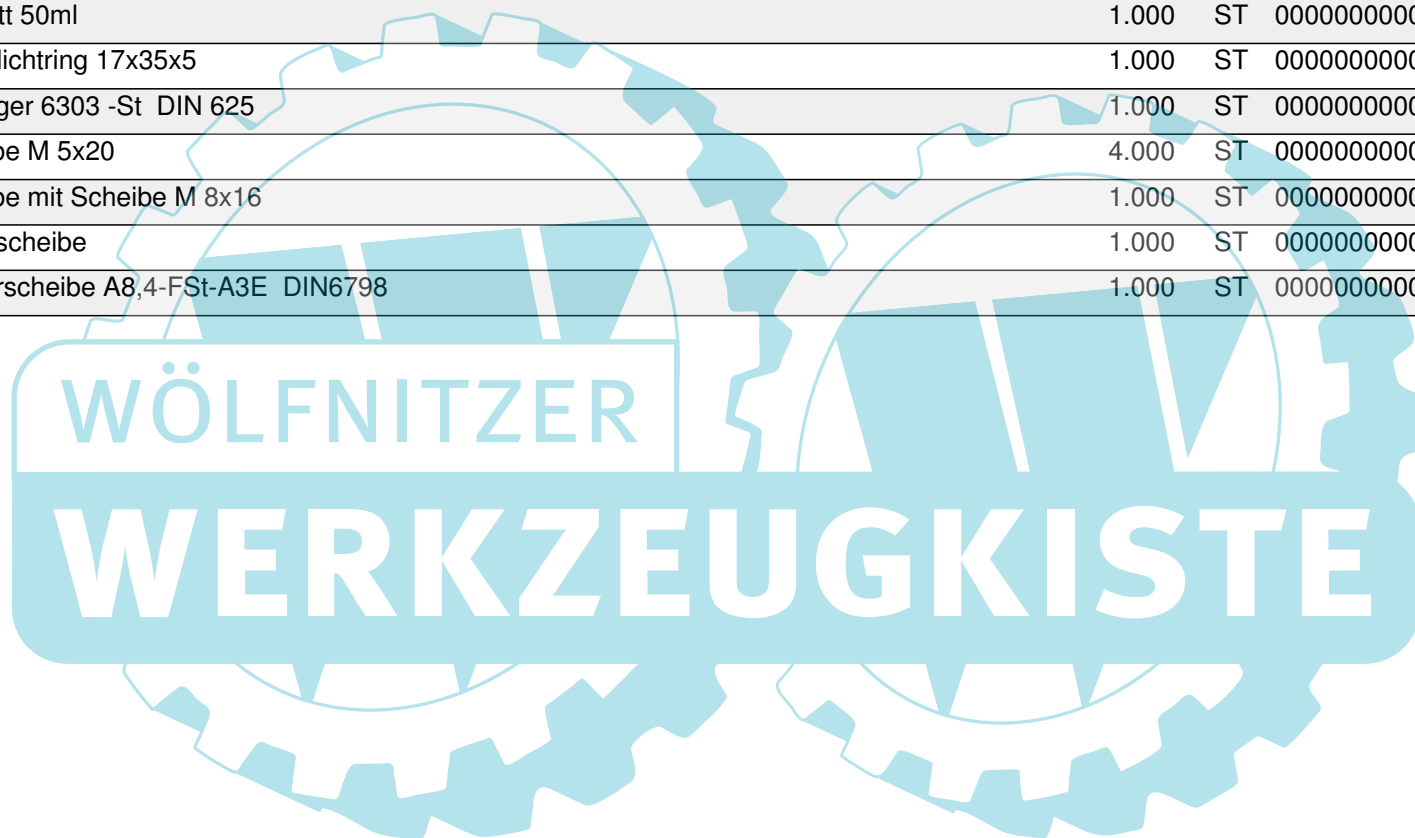

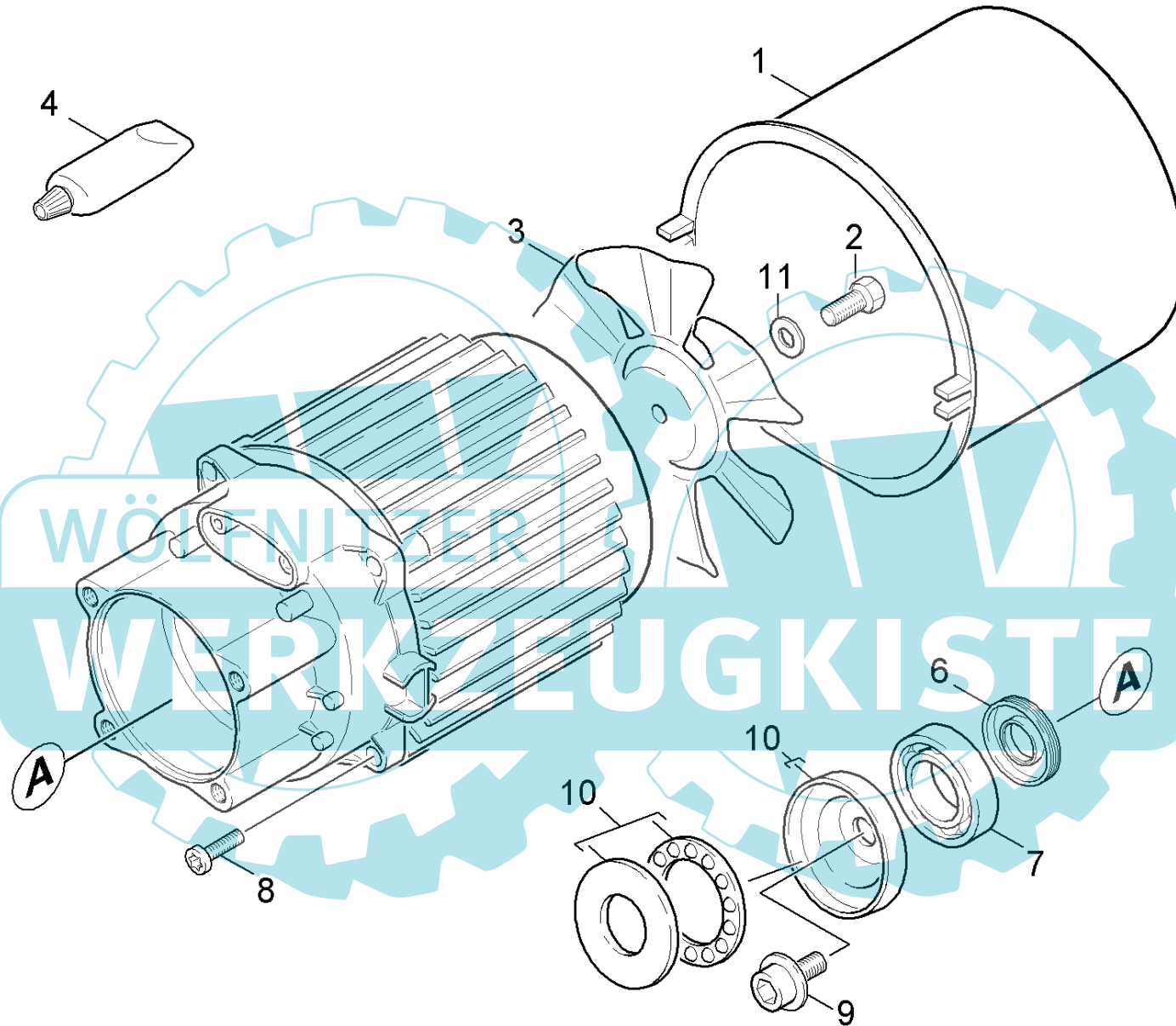

Pos	Materialnr.	Benennung	Menge	ME	ab WK Nr.	bis WK.Nr.	Preis (EUR)
1	6.964-090.0	Gehaeuse Luefter	1.000	ST	0000000000	0000000000	5,30
2	7.304-395.0	6kt-Schraube M8x16-8.8-A2E ISO 4017	1.000	ST	0000000000	0000000000	0,20
3	9.039-188.0	Luefterrad	1.000	ST	0000000000	0000000000	5,00
4	6.964-092.0	Fliessfett 50ml	1.000	ST	0000000000	0000000000	6,30
6	9.078-007.0	Wellendichtring 17x35x5	1.000	ST	0000000000	0000000000	6,70
7	7.401-010.0	Kugellager 6303 -St DIN 625	1.000	ST	0000000000	0000000000	7,50
8	9.086-185.0	Schraube M 5x20	4.000	ST	0000000000	0000000000	0,70
9	9.086-169.0	Schraube mit Scheibe M 8x16	1.000	ST	0000000000	0000000000	0,70
10	9.001-289.0	Taumelscheibe	1.000	ST	0000000000	0000000000	76,70
11	7.312-233.0	Faecherscheibe A8,4-FSt-A3E DIN6798	1.000	ST	0000000000	0000000000	0,10

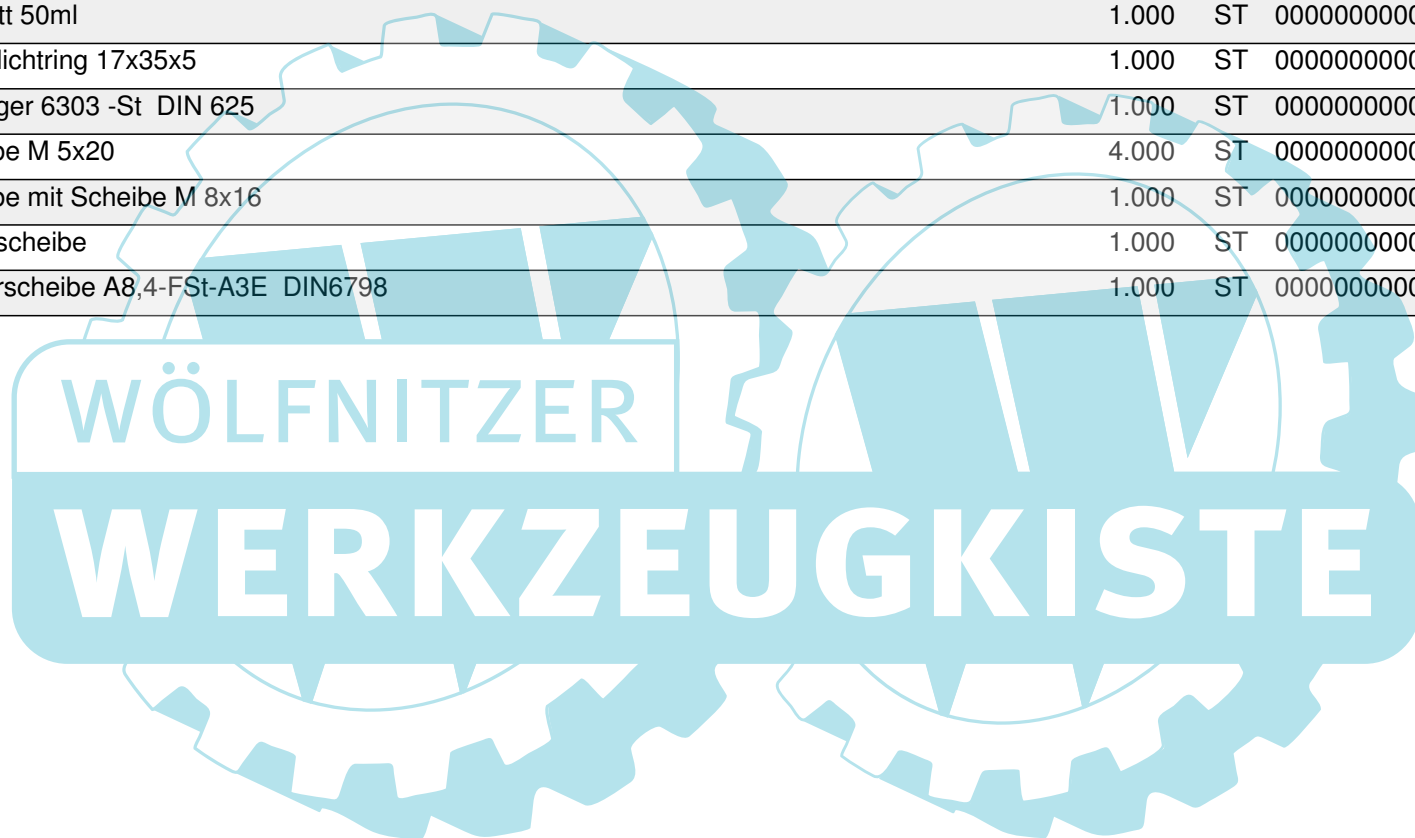

Pos	Materialnr.	Benennung	Menge	ME	ab WK Nr.	bis WK.Nr.	Var. Information	Preis (EUR)
41	0.148-424.0	Handspritzpistole	1.000	ST	0000000000	0000000000		a.A.
42	0.148-539.0	Handspritzpistole	1.000	ST	0000000000	0000000000		a.A.
43	0.105-822.0	Handspritzpistole	1.000	ST				a.A.
44	0.148-425.0	Strahlrohr	1.000	ST	0000000000	0000000000		a.A.
45	0.103-424.0	Flaechenreiniger	1.000	ST			T 200	a.A.
46	0.110-230.0	Flaechenreiniger	1.000	ST			T 250	a.A.
47	0.148-928.0	Flaechenreiniger	1.000	ST			T 300	a.A.

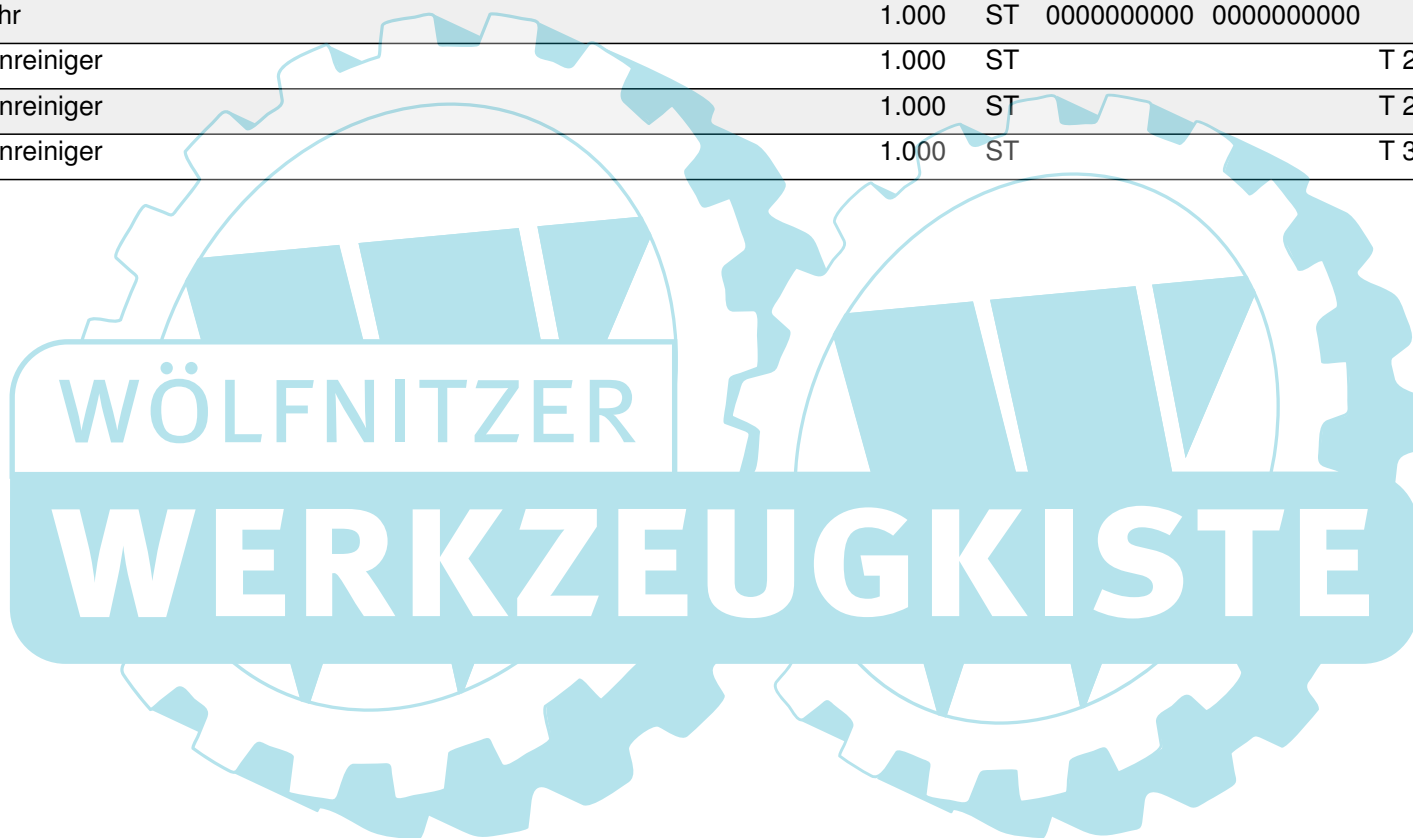



ET/VT	Pos	Materialnr.	Benennung	Menge	ME	ab WK Nr.	bis WK.Nr.	Var. Information	Preis (EUR)
	0	7.777-999.0	Bevorratung eingestellt	1.000	ST	0000000000	0000000000		a.A.
	1	5.037-164.0	Klammer	1.000	ST	0000000000	0000000000		0,50
	2	5.332-464.0	Druckfeder	1.000	ST	0000000000	0000000000		1,00
X-X	3	2.880-296.0	Ersatzteilsatz O-Ring 5x	1.000	ST	0000000000	0000000000		a.A.
X	4	4.440-673.0	HD-M-Schlauch 12/16MPa, Kaer., 60G	1.000	ST	0000000000	0000000000	12,0M	80,10
X-X	4	6.390-463.0	HD-M-Schlauch 9/16MPa	1.000	ST	0000000000	0000000000	9,0M	47,89
X-X	5	6.363-198.0	O-Ring 6x2 90 shore PUR	1.000	ST	0000000000	0000000000		0,60

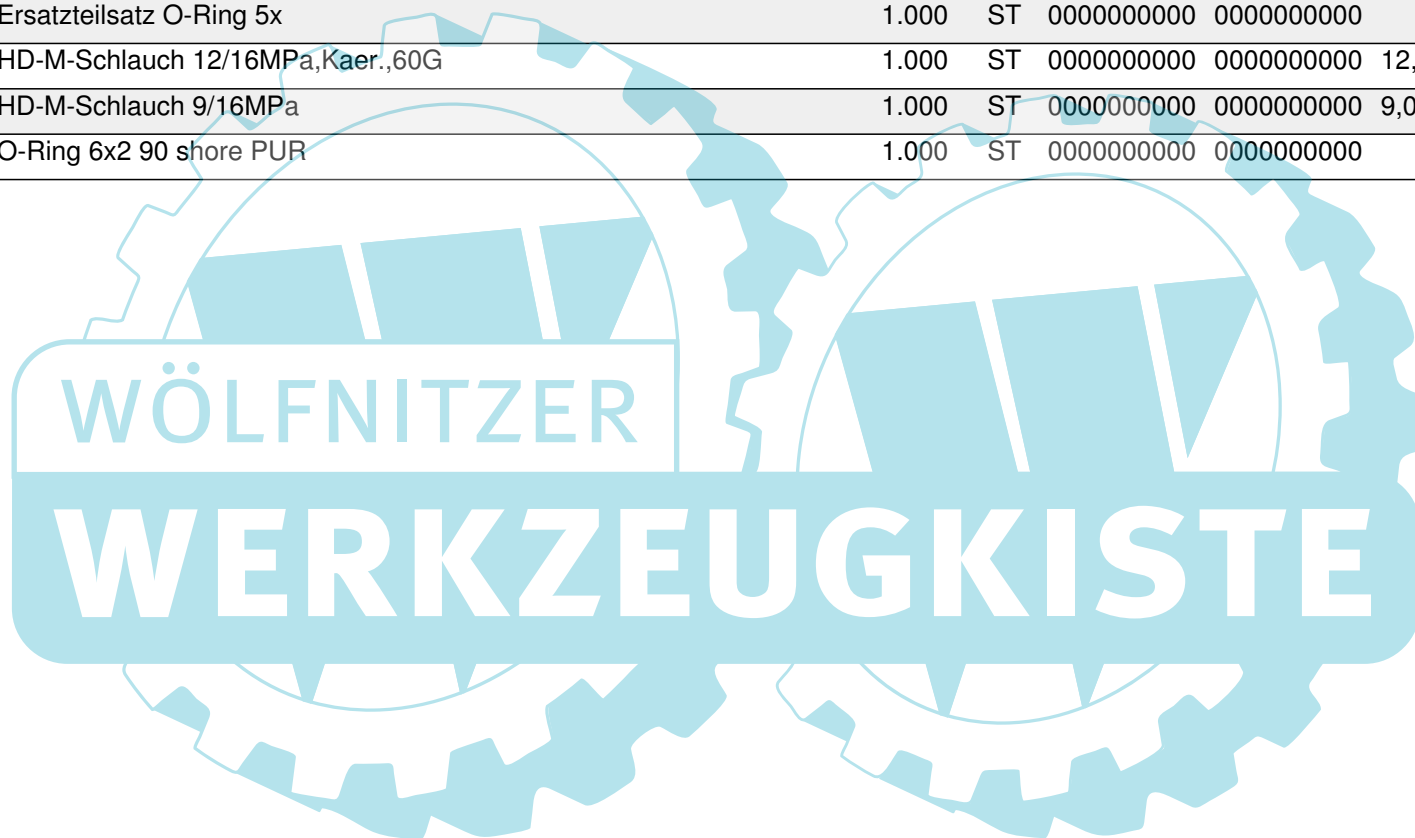

Pos	Materialnr.	Benennung	Menge	ME
10	6.362-957.0	O-Ring 10,0 X 2,0-EPDM 85-90	5.000	ST



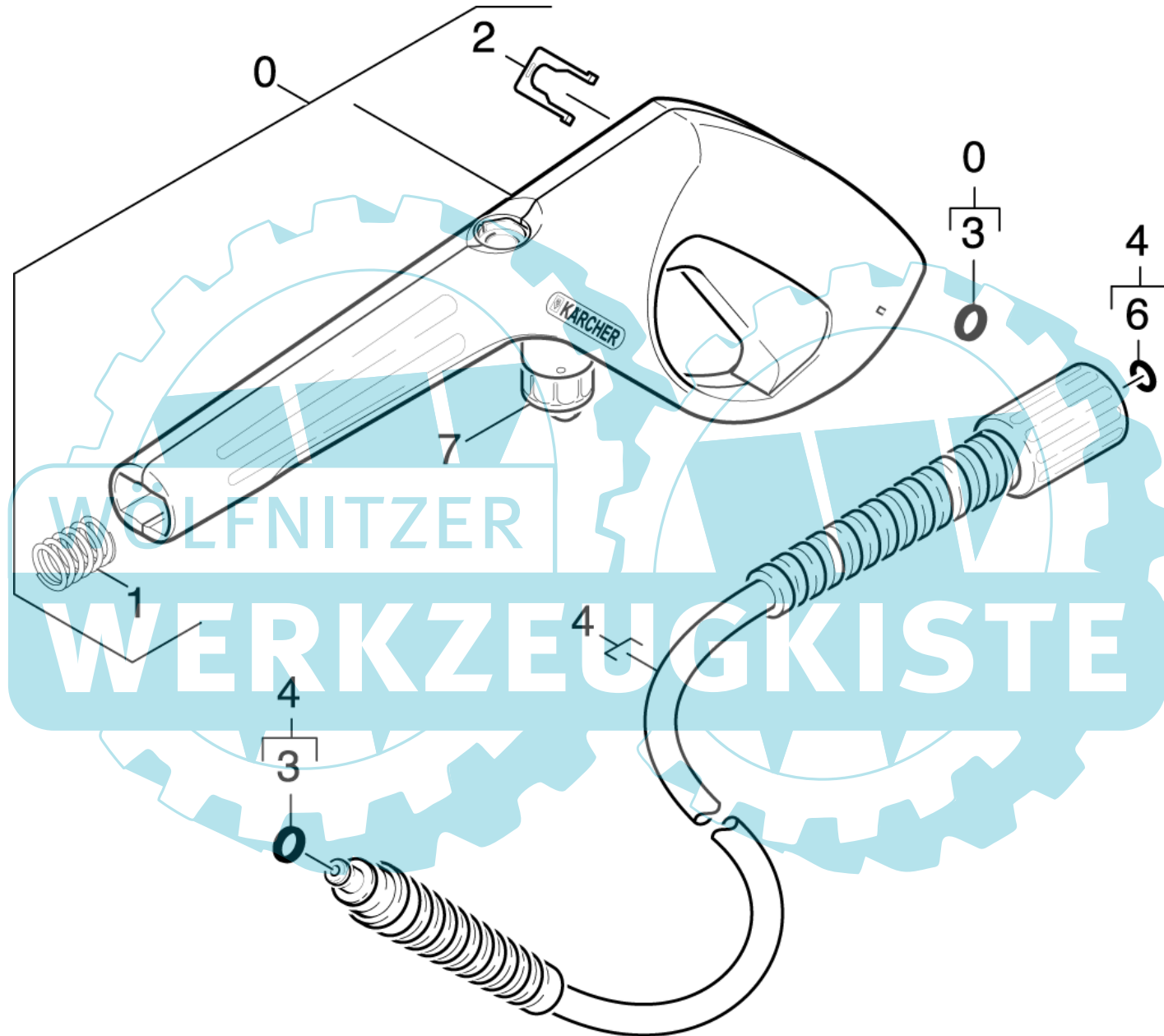

ET/VT	Pos	Materialnr.	Benennung	Menge	ME	ab WK Nr.	bis WK.Nr.	Preis (EUR)
	0	7.777-999.0	Bevorratung eingestellt	1.000	ST	0000000000	0000000000	a.A.
	1	5.332-464.0	Druckfeder	1.000	ST	0000000000	0000000000	1,00
X-X	2	5.037-140.0	Klammer	1.000	ST	0000000000	0000000000	0,50
X-X	3	6.363-198.0	O-Ring 6x2 90 shore PUR	1.000	ST	0000000000	0000000000	0,60
X-X	4	6.390-463.0	HD-M-Schlauch 9/16MPa	1.000	ST	0000000000	0000000000	47,89
X-X	6	2.880-296.0	Ersatzteilsatz O-Ring 5x	1.000	ST	0000000000	0000000000	a.A.
	7	5.132-154.0	Verschlussstopfen RM	1.000	ST	0000000000	0000000000	1,70
	100	2.883-945.0	Ersatzteilsatz Pistole V3	1.000	ST	0000000000	0000000000	10,50

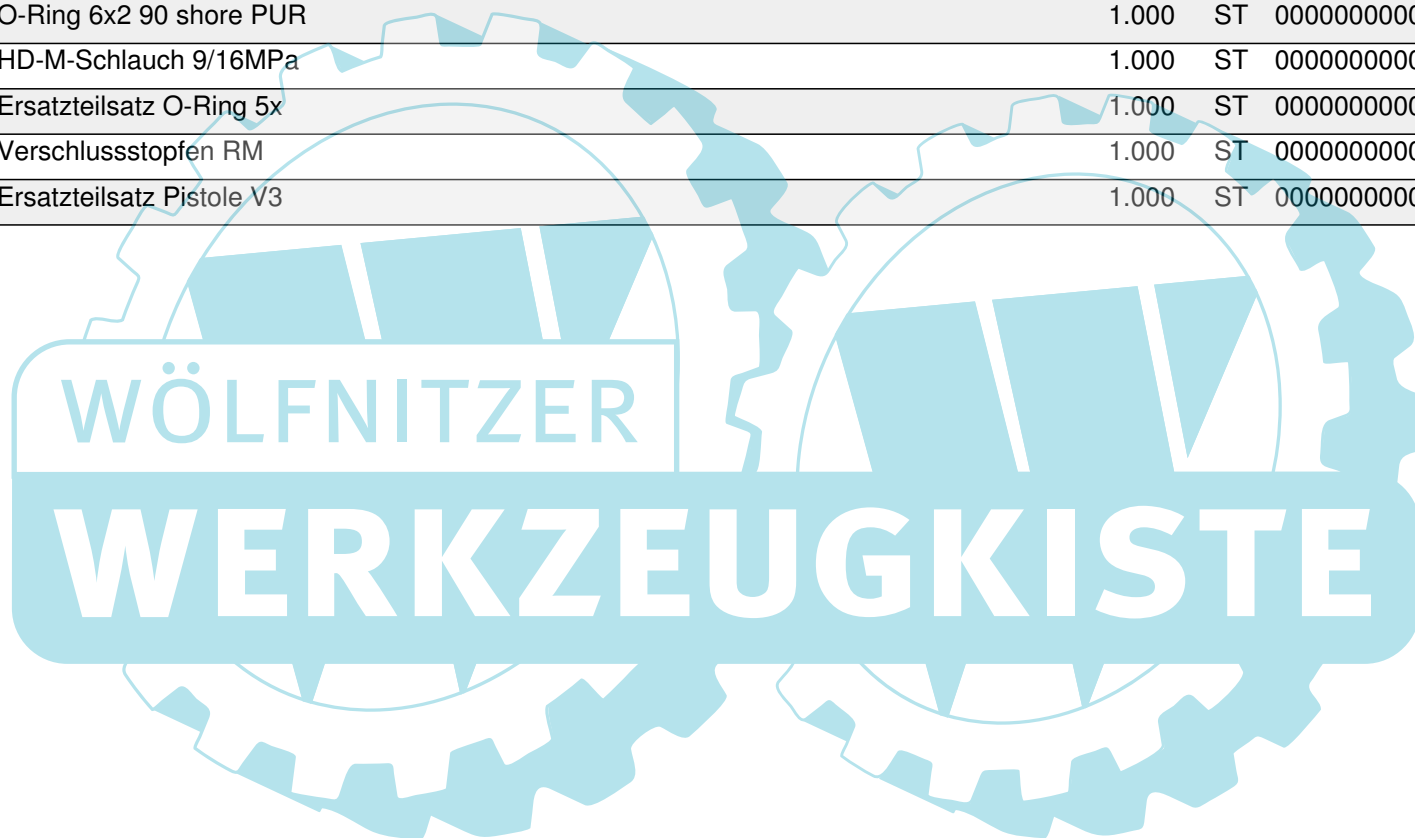

Pos	Materialnr.	Benennung	Menge	ME
10	6.362-957.0	O-Ring 10,0 X 2,0-EPDM 85-90	5.000	ST



ET/VT	Pos	Materialnr.	Benennung	Menge	ME
	10	5.132-154.0	Verschlussstopfen RM	1.000	ST
	20	5.291-083.0	Spindel RM	1.000	ST
	30	6.362-643.0	O-Ring 14,0 X 1,78-NBR 80	1.000	ST
X	40	6.363-142.0	O-Ring 10x1.5N BR 90	1.000	ST
	50	7.314-084.0	Zylinderstift 3m6x20-A1 ISO 2338	1.000	ST



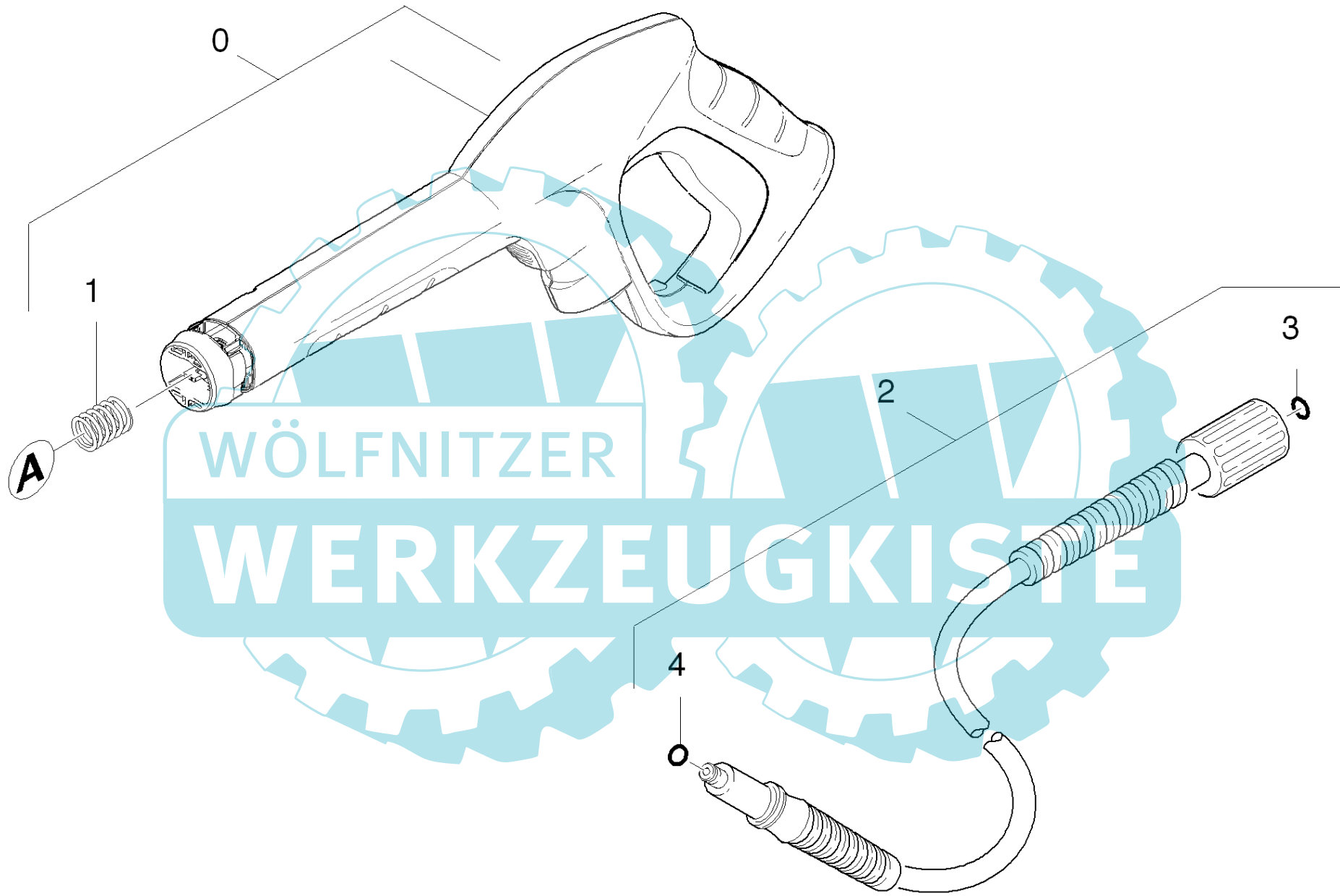

ET/VT	Pos	Materialnr.	Benennung	Menge	ME	Preis (EUR)
X-X	0	2.642-172.0	Pistole best 2K verpackt	1.000	ST	31,92
	1	5.332-464.0	Druckfeder	1.000	ST	1,00
X-X	2	2.641-706.0	HD-Schlauch 16MPa/9m 60°C, verp.	1.000	ST	46,21
X-X	3	2.880-296.0	Ersatzteilsatz O-Ring 5x	1.000	ST	a.A.
X-X	4	6.363-410.0	O-Ring 5,7x1,78 NBR 90Shore	1.000	ST	0,20



Pos	Materialnr.	Benennung	Menge	ME
10	6.362-957.0	O-Ring 10,0 X 2,0-EPDM 85-90	5.000	ST



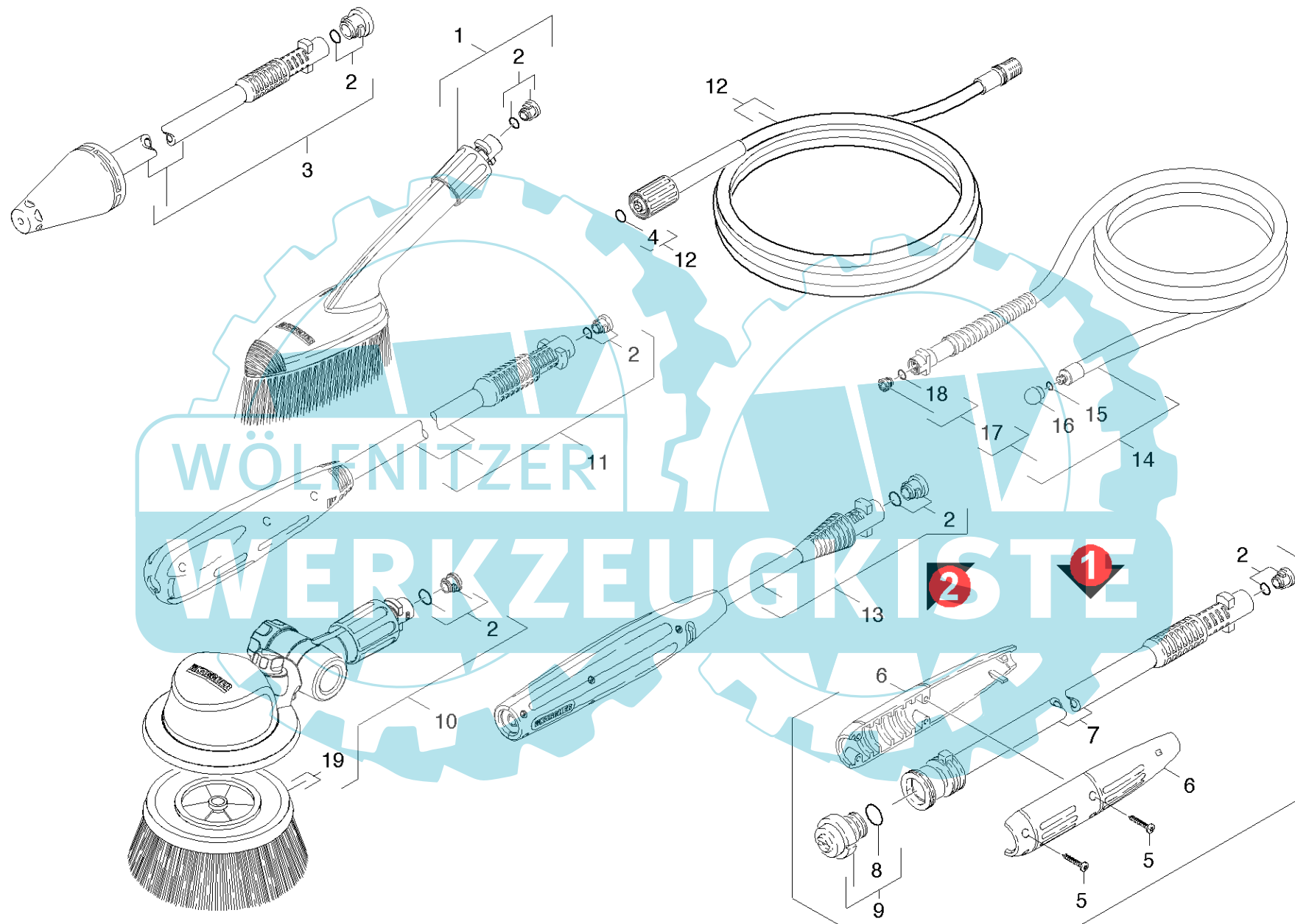

ET/VT	Pos	Materialnr.	Benennung	Menge	ME	ab WK Nr.	bis WK.Nr.	Preis (EUR)
X-X	1	2.640-589.0	Buerste laengs	1.000	ST	0000000000	0000000000	15,96
X-X	2	2.640-729.0	O-Ring Set	4.000	ST	0000000000	0000000000	10,08
X-X	3	4.763-228.0	Rotorduese 035 Clas.Line verpackt	1.000	ST	0000000000	0000000000	46,21
X-X	4	2.880-154.0	O-Ringset	1.000	ST	0000000000	0000000000	1,10
	5	6.303-122.0	Linsenschraube 4,2x13	6.000	ST	0000000000	0000000000	0,10
	6	9.036-402.0	Griffpaar kpl.	1.000	ST	0000000000	0000000000	8,30
	7	9.036-403.0	Rohr VPS	1.000	ST	0000000000	0000000000	20,80
X	8	6.362-534.0	O-Ring 18,0 X 2,0-NBR 70	1.000	ST	0000000000	0000000000	0,50
	9	7.777-999.0	Bevorratung eingestellt	1.000	ST	0000000000	0000000000	a.A.
X-X	10	2.640-907.0	Buerste BEST	1.000	ST	0000000000	0000000000	33,61
	11	7.777-999.0	Bevorratung eingestellt	1.000	ST	0000000000	0000000000	a.A.
X-X	12	6.390-243.0	Verlaengerungsschlauch 6m	1.000	ST	0000000000	0000000000	42,01
X-X	13	4.760-534.0	VPS K3 0287	1.000	ST	0000000000	0000000000	32,20
X-X	14	2.637-729.0	Rohrreinigungsschlauch 7,5m	1.000	ST	0000000000	0000000000	66,38
X	15	6.362-388.0	O-Ring 8,0x1,5 -EPDM 70	1.000	ST	0000000000	0000000000	0,20
	16	5.763-022.0	Duese Kärcher	1.000	ST	0000000000	0000000000	30,30
	17	2.883-112.0	Ersatzteilsatz Verschlusschraube	1.000	ST	0000000000	0000000000	6,70
	18	6.362-642.0	O-Ring d. 7,65x1,78 -NBR 80	1.000	ST	0000000000	0000000000	0,30
	19	5.762-331.0	Traeger Buersten	1.000	ST	0000000000	0000000000	8,70

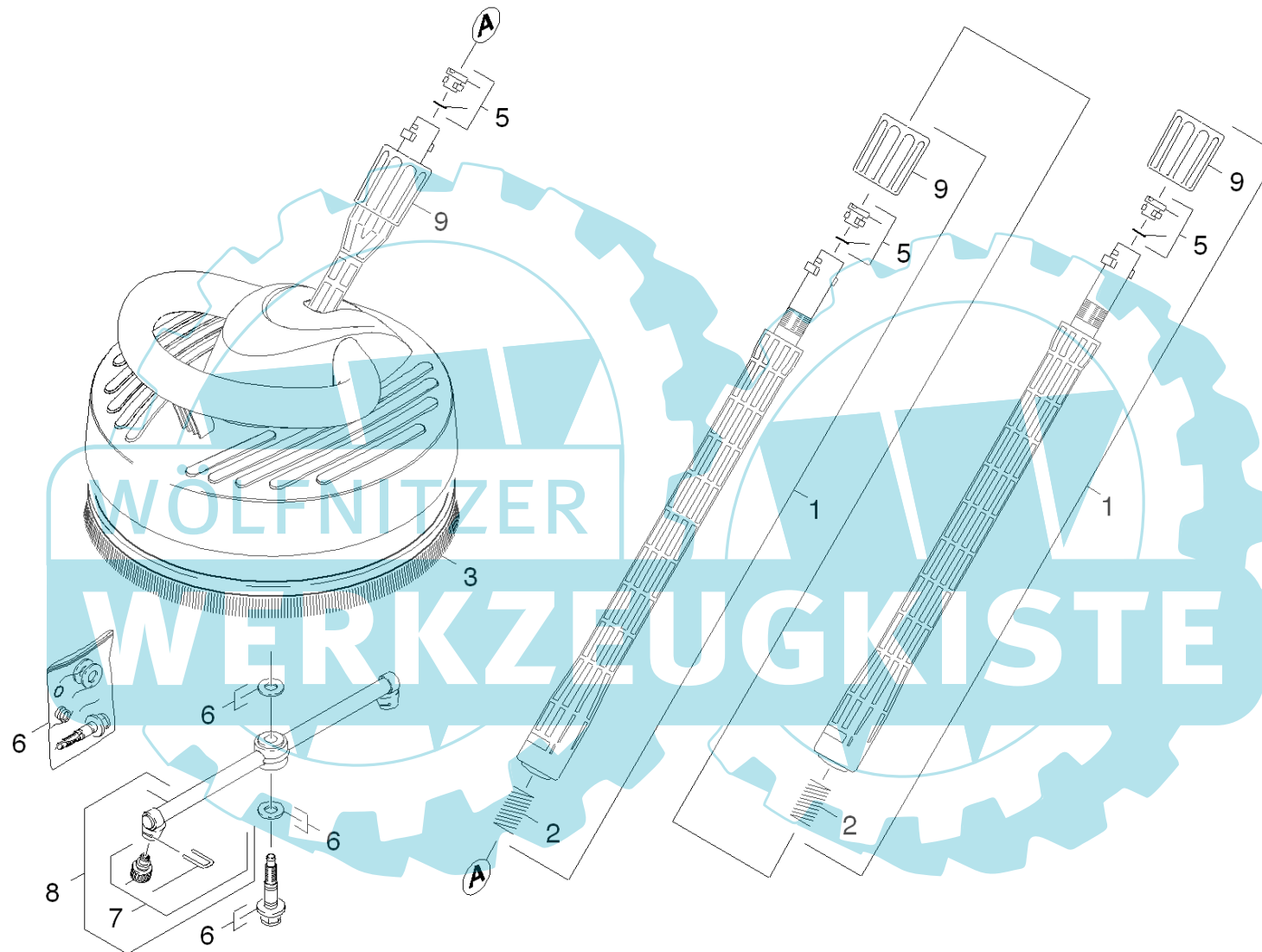

ET/VT	Pos	Materialnr.	Benennung	Menge	ME	Fußnotentext	Preis (EUR)
X-X	1	4.760-262.0	Strahlrohrverlaengerung 0,4m	2.000	ST		15,96
	2	5.332-464.0	Druckfeder	2.000	ST		1,00
	3	6.371-086.0	Streifenbuerste	1.000	ST		6,80
X-X	5	2.640-729.0	O-Ring Set	3.000	ST		10,08
	6	2.883-994.0	Ersatzteilsatz Dichtungssatz neutral	1.000	ST		11,50
X-X	7	2.640-727.0	Ersatzteilsatz Duesen 015	1.000	ST	GRAU	7,55
	7	2.641-556.0	Ersatzteilsatz Duesen 027	1.000	ST	SCHWARZ	11,70
	8	2.885-003.0	Ersatzteilsatz Rotor neutral	1.000	ST		29,70
	9	5.311-214.0	Mutter	3.000	ST		1,80



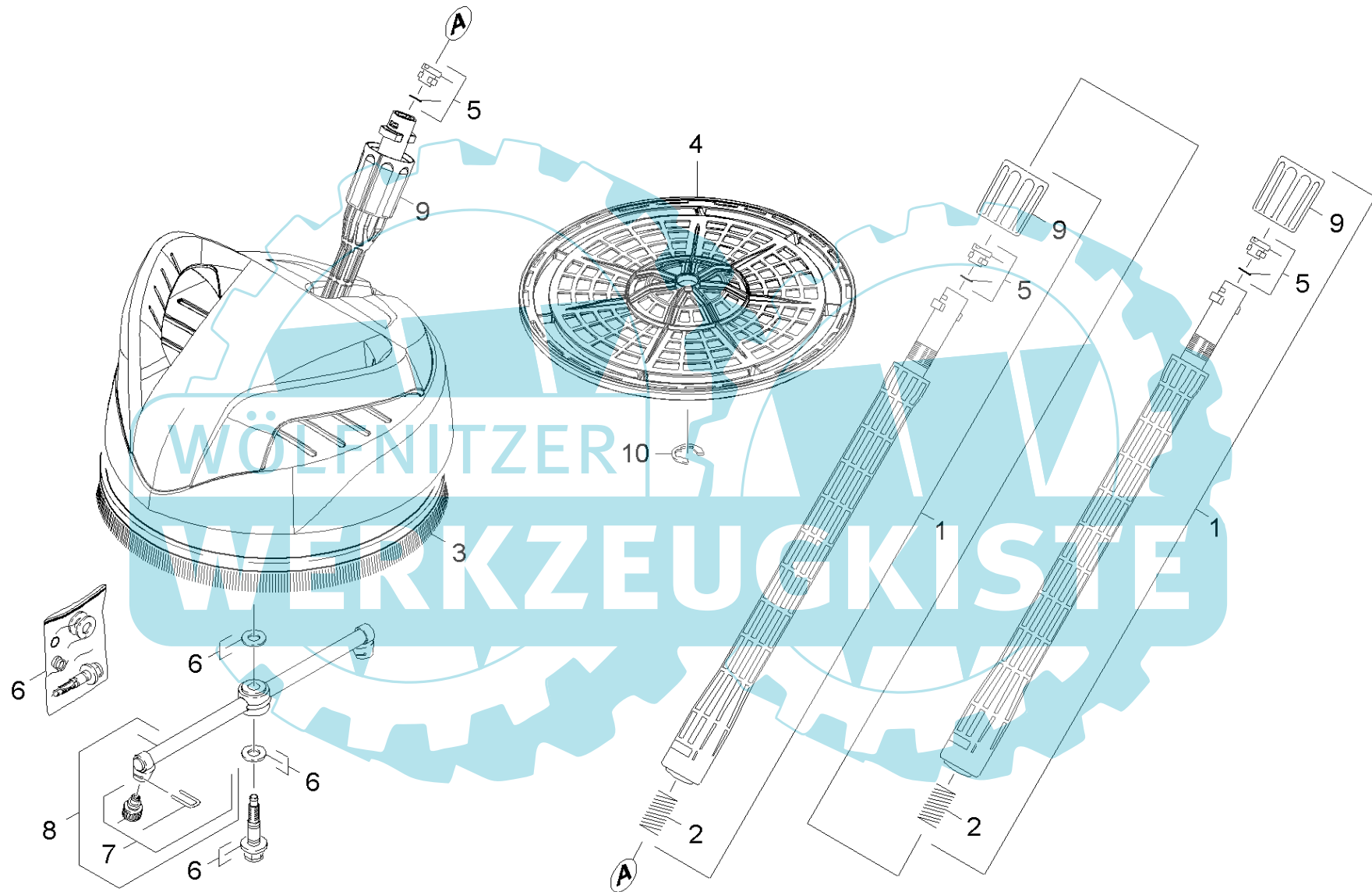

ET/VT	Pos	Materialnr.	Benennung	Menge	ME	ab WK Nr.	bis WK.Nr.	Fußnotentext	Preis (EUR)
X-X	1	4.760-262.0	Strahlrohrverlaengerung 0,4m	2.000	ST	0000000000	0000000000		15,96
	2	5.332-464.0	Druckfeder	2.000	ST	0000000000	0000000000		1,00
	3	6.371-086.0	Streifenbuerste	1.000	ST	0000000000	0000000000		6,80
	4	5.394-865.0	Gitter T 250 Plus	1.000	ST	0000000000	0000000000		3,10
X-X	5	2.640-729.0	O-Ring Set	3.000	ST	0000000000	0000000000		10,08
	6	2.883-963.0	Dichtungssatz T-RACER	1.000	ST	0000000000	0000000000		21,60
X-X	7	2.640-727.0	Ersatzteilsatz Duesen 015	1.000	ST	0000000000	0000000000	GRAU	7,55
X	7	2.640-642.0	Ersatzteilsatz Duesen 020	1.000	ST	0000000000	0000000000	GELB	7,55
	8	2.885-182.0	Ersatzteilsatz Rotor T 250 plus	1.000	ST	0000000000	0000000000		29,70
	9	5.311-214.0	Mutter	3.000	ST				1,80
	10	7.343-206.0	Sicherungsscheibe 12-2.1030 DIN 6799	1.000	ST				0,50

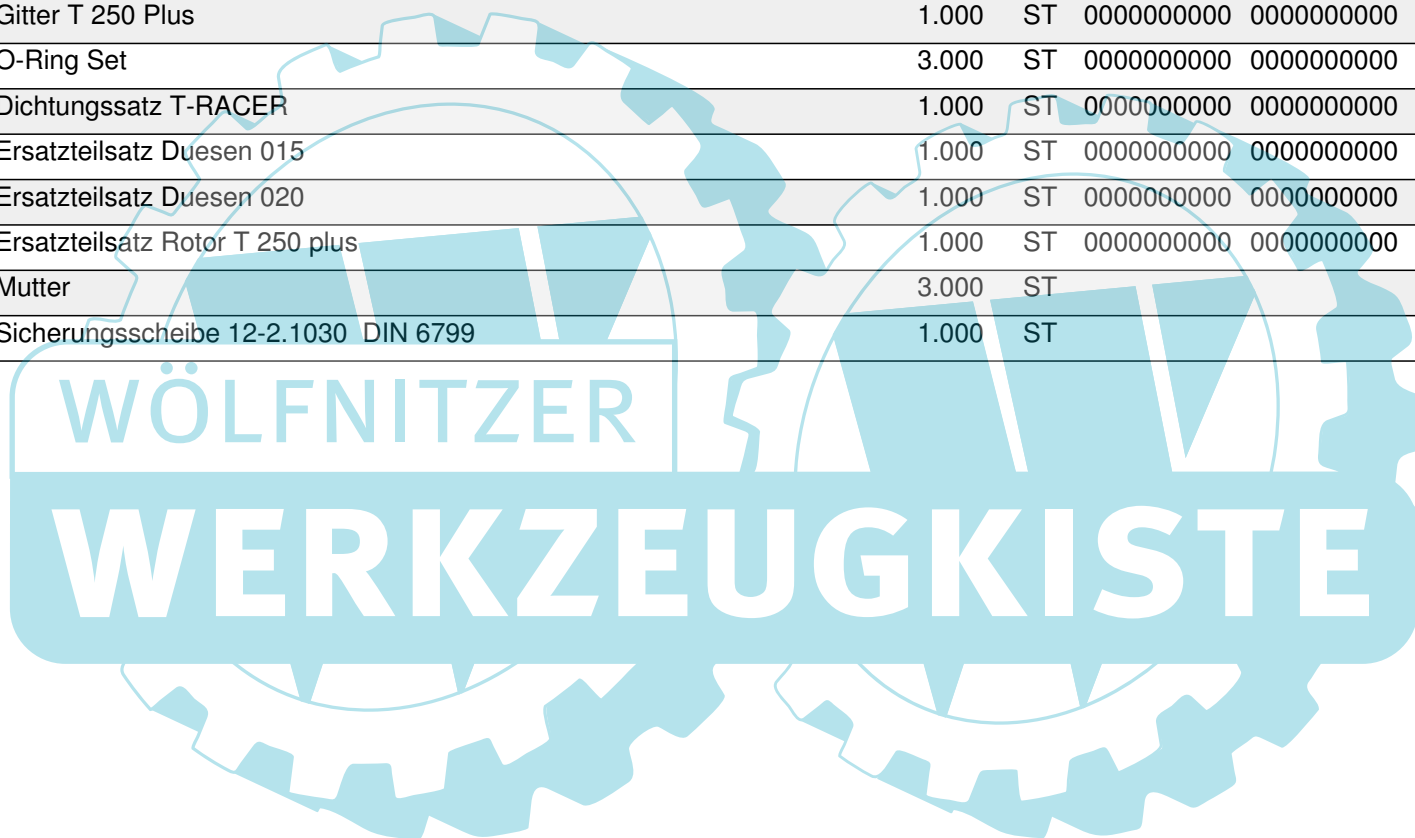

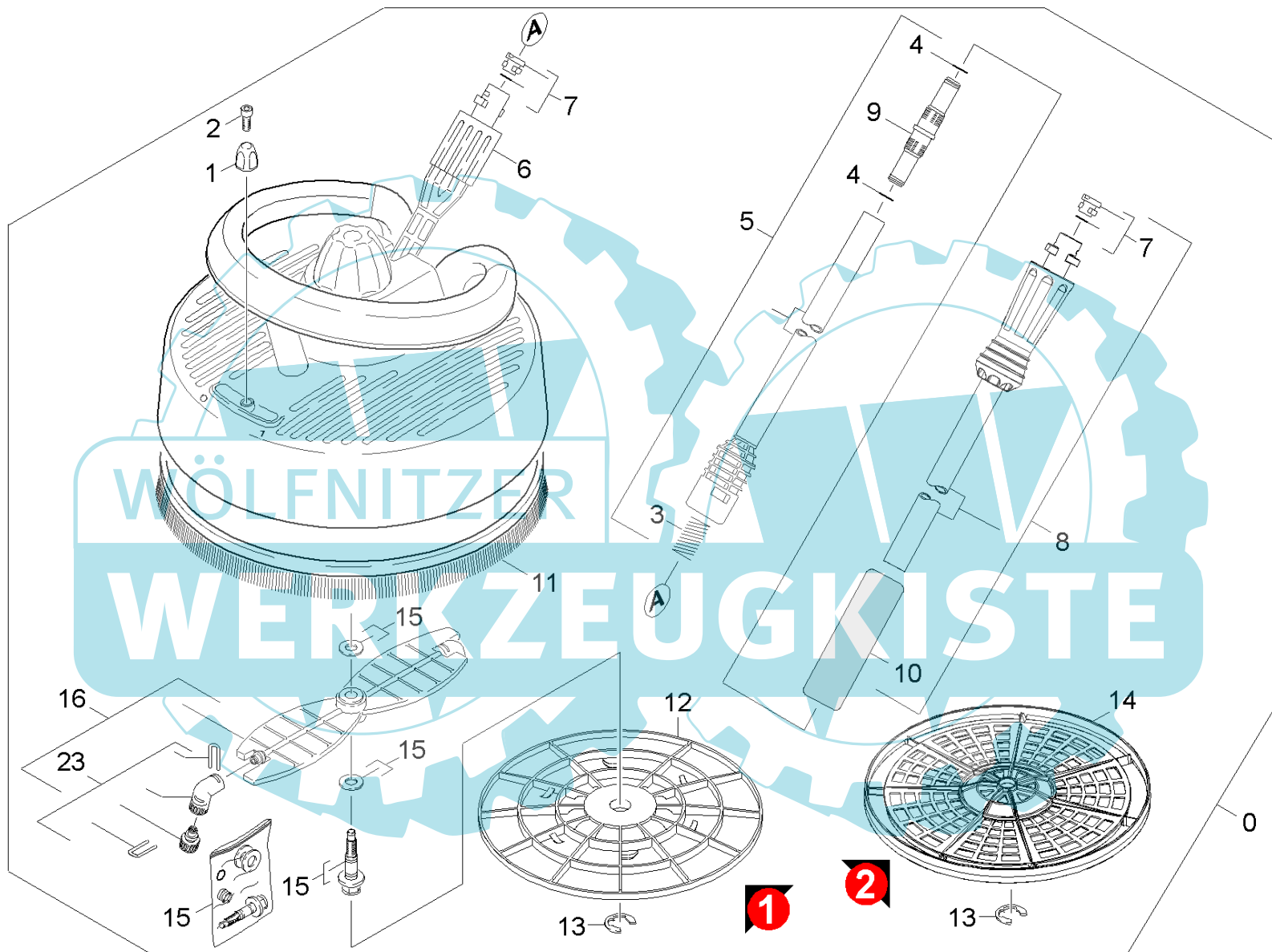

ET/VT	Pos	Materialnr.	Benennung	Menge	ME	ab WK Nr.	bis WK.Nr.	Fußnotentext	Preis (EUR)
X-X	0	2.640-212.0	T 300 Plus	1.000	ST				73,94
	1	7.777-999.0	Bevorratung eingestellt	1.000	ST	0000000000	0000000000		a.A.
	2	7.303-092.0	Schraube 3x12 -10.9-R2R (K-In6Rd)	1.000	ST	0000000000	0000000000		0,30
	3	5.332-464.0	Druckfeder	1.000	ST	0000000000	0000000000		1,00
	4	6.362-577.0	O-Ring 11,0 X 1,5-NBR 70	1.000	ST	0000000000	0000000000		0,50
	5	4.760-495.0	Strahlrohr	1.000	ST	0000000000	0000000000		15,80
	6	5.311-214.0	Mutter	1.000	ST	0000000000	0000000000		1,80
X-X	7	2.640-729.0	O-Ring Set	2.000	ST	0000000000	0000000000		10,08
	8	4.760-688.0	Strahlrohr PS	1.000	ST	0000000000	0000000000		15,80
	9	5.471-105.0	Kupplungsteil Strahlrohrverlaengerung	1.000	ST				1,40
	10	6.321-160.0	Griff Schaumstoff	1.000	ST	0000000000	0000000000		3,30
	11	6.369-738.0	Streifenbuerste	1.000	ST	0000000000	0000000000		8,50
	12	5.394-661.0	Schutzteil	1.000	ST	0000000000	0000000000		2,70
	13	7.343-206.0	Sicherungsscheibe 12-2.1030 DIN 6799	1.000	ST	0000000000	0000000000		0,50
	14	5.394-872.0	Gitter T 300 Plus	1.000	ST				3,30
	15	2.883-963.0	Dichtungssatz T-RACER	1.000	ST	0000000000	0000000000		21,60
	16	2.883-973.0	Ersatzteilsatz Rotor	1.000	ST	0000000000	0000000000		23,90
X	23	2.640-642.0	Ersatzteilsatz Duesen 020	1.000	ST	0000000000	0000000000	GELB	7,55
X-X	23	2.640-727.0	Ersatzteilsatz Duesen 015	1.000	ST	0000000000	0000000000	GRAU	7,55

Pos	Materialnr.	Benennung	Menge	ME	ab WK Nr.	bis WK.Nr.	Var. Information	Preis (EUR)
51	0.127-126.0	E-Kasten	1.000	ST	0000000000	0000299999	Version 1	a.A.
52	0.127-198.0	E-Kasten	1.000	ST	0000300000	0000000000	Version 2	a.A.





ET/VT	Pos	Materialnr.	Benennung	Menge	ME	ab WK Nr.	bis WK.Nr.	Var. Information	Preis (EUR)
	1	9.001-100.0	Deckel E-Kasten kpl.	1.000	ST	0000000000	0000000000		11,90
X	2	7.303-114.0	Schraube 6 x 35-ST-10.9-A2R (IN6RD)	1.000	ST	0000000000	0000000000		0,40
X	3	9.085-013.0	Kondensator 25mF	1.000	ST	0000000000	0000000000		8,70
	4	9.036-348.0	Gehaeuse E-Kasten	1.000	ST	0000000000	0000000000		2,60
	5	9.081-408.0	O-Ring 19x34x2,62	1.000	ST	0000000000	0000000000		0,40
	6	9.048-011.0	Durchfuehrungstuelle	1.000	ST	0000000000	0000000000		0,50
	7	6.303-320.0	Schraube M 5x 20-St-R2R	2.000	ST	0000000000	0000000000		0,70
	8	9.085-031.0	Schalter 2-polig	1.000	ST	0000000000	0000000000		3,60
	9	9.084-075.0	Kabel mit Stecker	1.000	ST	0000000000	0000000000	(EU)	23,20
	9	9.084-070.0	Kabel mit Stecker *CH	1.000	ST	0000000000	0000000000	(CH)	24,20
	9	9.084-064.0	Kabel mit Stecker	1.000	ST	0000000000	0000000000	(GB)	23,50
	9	9.084-065.0	Kabel mit Stecker -AUS/NZ	1.000	ST	0000000000	0000000000	(AU/NZ)	24,90
	15	9.036-818.0	Schaltknopf	1.000	ST	0000000000	0000000000		1,40



WOLFENITZER
WERKZEUGKISTE



ET/VT	Pos	Materialnr.	Benennung	Menge	ME	ab WK Nr.	bis WK.Nr.	Var. Information	Preis (EUR)
	0	9.001-394.0	E-Kasten kpl.	1.000	ST	0000000000	0000000000	(GB)	46,20
	0	9.001-550.0	E-Kasten	1.000	ST	0000000000	0000000000	(EU)	46,90
	0	9.001-557.0	E-Kasten	1.000	ST	0000000000	0000000000	(AU/NZ)	46,90
	0	9.001-447.0	E-Kasten	1.000	ST	0000000000	0000000000	(CH)	46,90
X	1	9.085-013.0	Kondensator 25mF	1.000	ST	0000000000	0000000000		8,70
	2	9.084-290.0	Kabel mit Stecker 3G1 *CH	1.000	ST	0000000000	0000000000	(CH)	a.A.
	2	9.084-146.0	Kabel mit Stecker *AU	1.000	ST	0000000000	0000000000	(AU/NZ)	21,10
	2	9.084-139.0	Kabel mit Stecker *EU	1.000	ST	0000000000	0000000000	(EU)	16,80
	2	9.084-144.0	Kabel mit Stecker	1.000	ST	0000000000	0000000000	(GB)	20,30
	4	9.080-465.0	Dichtring Kondensator d.45, 70 Shore	1.000	ST	0000000000	0000000000		1,00
	5	9.081-417.0	O-Ring 20 x 2	1.000	ST	0000000000	0000000000		0,50

