

IBEA

Modello n.	Serie dal n.
IB-5324F	001
IB-5328F	001
IB-5329F	001
IB-5342F	001

Stampato n. P5090151

LISTA RICAMBI

SPARE PART LIST

ERSATZTEILLISTE

LISTE DES PIECES DE RECHANGE

25
26



50
31

1110
P102

SERIE 530

Ihr Ersatzteilspezialist im Internet

REF. N°	PART. N°	QTY	DESCRIZIONE	DESCRIPTION	DESCRIPTION	BESCHREIBUNG
1	P5140532	1	DECALCO	DECAL	MARQUAGE	AUFKLEBER
2	P5140334	1	DECALCO	DECAL	MARQUAGE	AUFKLEBER
3	P5140538	1	DECALCO	DECAL	MARQUAGE	AUFKLEBER
4	P5140555	1	DECALCO	DECAL	MARQUAGE	AUFKLEBER
5	P5140545	1	DECALCO	DECAL	MARQUAGE	AUFKLEBER
6	P5140549	1	DECALCO	DECAL	MARQUAGE	AUFKLEBER
7	P5140531	1	DECALCO	DECAL	MARQUAGE	AUFKLEBER
8	P5140547	1	DECALCO	DECAL	MARQUAGE	AUFKLEBER
9	P5140548	1	DECALCO	DECAL	MARQUAGE	AUFKLEBER
10	P5140535	1	DECALCO	DECAL	MARQUAGE	AUFKLEBER
11	P5140573	1	DECALCO	DECAL	MARQUAGE	AUFKLEBER
*	P5110008	1	CHIAVE	KEY	CLEF	SCHLÜSSEL
*	P5090161	1	MANUALE ISTRUZIONI	INSTRUCTION MANUAL	MODE D'EMPLOI	BEDIENUNGSANLEITUNG

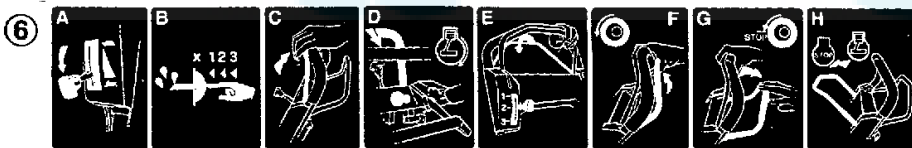
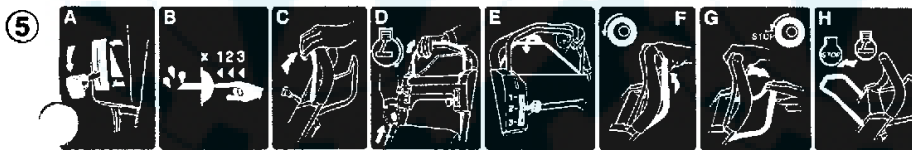
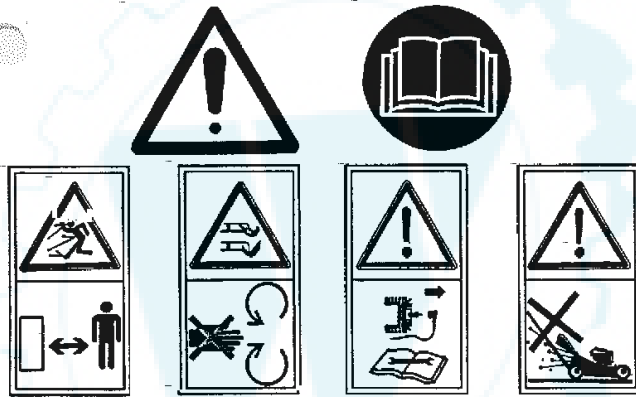

11 STOP ↑

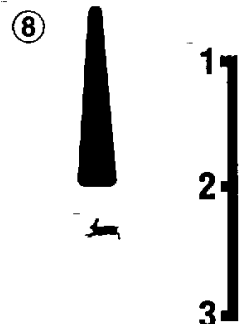

REF. N°	PART. N°	QTY	DESCRIZIONE	DESCRIPTION	DESCRIPTION	BESCHREIBUNG
1.	P2020187	1	SCIVOLO ERBA	CHUTE DOOR	DÉFLECTEUR	LEITBLECH
2	P00011098	1	TELAIO CESTELLO	BAG FRAME	MONTURE	GESTELL
3	P3160042	1	SACCO	BAG	SAC	GRASFANGSACK
4	P2020149	1	DEFLETTORE	GRASS DEFLECTOR	DÉFLECTEUR	SCHUTZ
5	2020050A1	2	POMELLO	KNOB	POIGNÉE	MUTTER
6	P1050011	2	DADO	NUT	ECROU	MUTTER
7	P3120095VEN	1	STEGOLA INF. DX	LOWER HANDLEBAR	GUIDON INFÉRIEUR	HOLMUNTERTEIL
8	1010026A1	2	VITE	SCREW	VIS	SCHRAUBE
9	P1050011	2	DADO	NUT	ÉCROU	MUTTER
10	P1010082	2	VITE	SCREW	VIS	SCHRAUBE
11	P1010070	2	VITE	SCREW	VIS	SCHRAUBE
12		1	MOTORE	ENGINE	MOTEUR	MOTOR
13	P1050011	3	DADO	NUT	ECROU	MUTTER
14	P3120096VEN	1	STEGOLA INF. SX	LOWER HANDLEBAR	GUIDON INFÉRIEUR	HOLMUNTERTEIL
15	P3020027	2	MOLLA	SPRING	RESSORT	FEDER
16	P3140238	2	DISTANZIALE	SPACER	DOUILLE	ABSTANDSSTÜCK
17	P2020203	2	TUBO	STRIP	JOINT	DICHTUNG
18	P2020189	1	PORTELLO	SHIELD	PROTECTION	KLAPPE
19	P2020062	2	COPRIMOZZO	COVER	COUVERCLE	DECKEL
20	1010018A1	2	VITE	SCREW	VIS	SCHRAUBE
21	1020007A1	2	RONDELLA	WASHER	RONDELLE	SCHIBE
22	P2020083	2	COPERTONE	TYRE	PNEU	REIFEN
23	P3030013	4	CUSCINETTO	BEARING	PALIER	LAGER
24	P2020082	2	CERCHIO ANTERIORE	FRONT HUB	JANTE ANT.	FELGE
25	P2020128	2	WHEEL COVER	WHEEL COVER	PROTECTION	ABDECKUNG
26	P00015176	2	RUOTA ANTERIORE	FRONT WHEEL ASS.Y	ROUE ANT. COMPL.	RAD KOMPL.
27	P2020088	2	DISTANZIALE	SPACER	RONDELLE	DISTANZBÜCHSE
28	P1020050	2	RONDELLA	SPRING WASHER	RONDELLE ÉLASTIQUE	FEDERSCHIBE
29	P4020028	2	PORTA RUOTA ANTERIORE	FRONT WHEEL SUPPORT	SUPPORT ROUE AVANT	RADHALTER
30	P1010116	2	VITE	SCREW	VIS	SCHRAUBE
31	P3040118	1	BUSSOLA	BUSHING	DOUILLE	BÜCHSE
32	P4020038	1	LEVA ANTERIORE DESTRA	RIGHT WHEEL LEVER	LEVIER ROUE DROITE	RADHEBEL R.
32	P4020039	1	LEVA ANTERIORE SINISTRA	LEFT WHEEL LEVER	LEVIER ROUE GAUCHE	RADHEBEL L.
33	P3040118	2	BUSSOLA	BUSHING	DOUILLE	BÜCHSE
34	P2020077	2	POMELLO	KNOB	POIGNÉE	KNOPF
35	P1010079	2	VITE	SCREW	VIS	SCHRAUBE
36	P1010122	2	VITE	SCREW	VIS	SCHRAUBE
37	5040001A1	2	FASCETTA	CLAMP	COLLIER	RAPBAND
38	P2020087	2	FERMACAVO	RING	BAGUE	RING
39	P1080018	2	PERNO	PIN	GOUILLE	STIFT
40	P2020188	1	COPRICINGHIA	BELT COVER	PROTECTION	KEILRIEMEN
41	P1060004	2	FISSATORE	WASHER	RONDELLE	SCHIBE
42	P020050101	1	SCOCCA	DECK	CHÂSSIS	GEHÄUSE
43	1020014A1	3	RONDELLA	WASHER	RONDELLE	SCHIBE
44	P1010097	2	VITE MOTORE	SCREW (B&S)	VIS (B&S)	SCHRAUBE (B&S)
44	P1010098	1	VITE MOTORE	SCREW (B&S)	VIS (B&S)	SCHRAUBE (B&S)
44	P1010135	3	VITE MOTORE (TECNA)	SCREW (TECNA)	VIS (TECNA)	SCHRAUBE (TECNA)
45	P1050012	2	DADO	NUT	ECROU	MUTTER
46	1090001A1	1	CHIAVETTA	KEY	CLAVETTE	SCHIBENFEDER
47	P3040104	1	BUSSOLA LAMA	BLADE BUSHING	DOUILLE DE COUTEAU	MESSERBÜCHSE
48	P4050019	1	LAMA	BLADE	LAME	MESSER
49	1110002A1	1	MOLLA	SPRING	RESSORT	FEDER
50	P1020067	1	RONDELLA	WASHER	RONDELLE	SCHIBE
51	P1010128	1	VITE LAMA	BLADE SCREW	VIS DE COUTEAU	MESSERSCHRAUBE
52	P01032298	1	TRAVERSINO	BRACE	RENFORCEMENT	VERSTEIFUNG
53	1010024A1	4	VITE	SCREW	VIS	SCHRAUBE
54	1050002A1	2	DADO	NUT	ECROU	MUTTER
55	P2020165	1	CAPOTTINA MOTORE	ENGINE COVER	COUVERCLE MOTEUR	MOTORABDECKUNG
56	P1010154	2	VITE	SCREW	VIS	SCHRAUBE
57	P00010098	1	CESTELLO COMPLETO	GRASS BAG ASS.Y	SAC DE RAMASSAGE COMPI	GRASFANGSACK KOMPL.

Tav. 2

Assale posteriore (a spinta)
Rear axle (push model)
Essieu arrière (à pousser)
Hinterachse (handgestoßen)

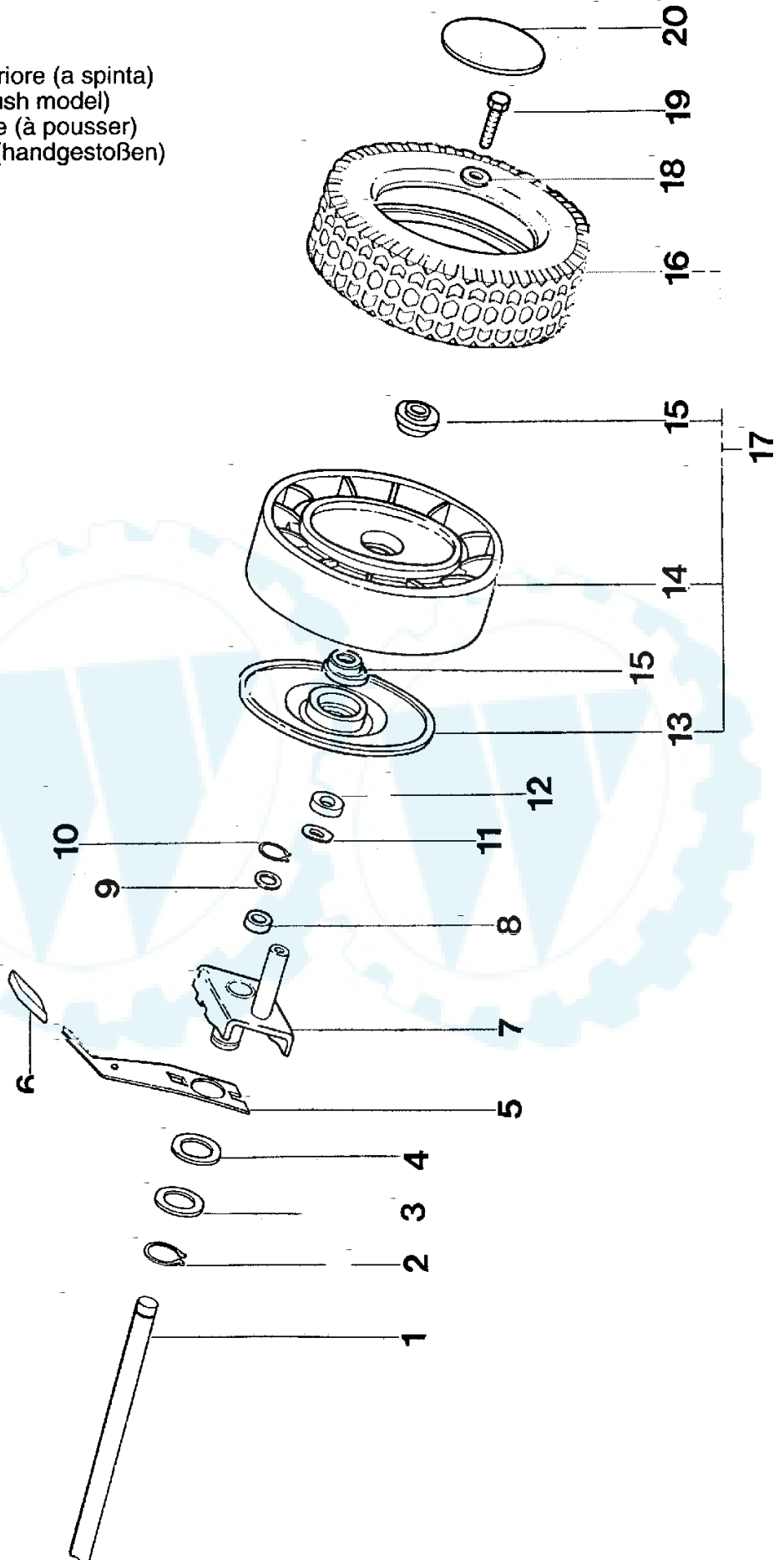

www.ersatzteil-service.de

www.ersatzteilplan.de

REF. N°	PART. N°	QTY	DESCRIZIONE	DESCRIPTION	DESCRIPTION	BESCHREIBUNG
1	P3040078	1	ALBERO	SHAFT	ARBRE	WELLE
2	P1070008	2	SEGER	CIRCLIP	SEGER	SEGER
3	P1020058	2	RONDELLA	SPACER	DOUILLE	ABSTANDSSTÜCK
4	P1020057	2	RONDELLA	SPACER	DOUILLE	ABSTANDSSTÜCK
5	P4020019	1	LEVA ALZAR. POST. SIN.	LEFT REAR WHEEL LEVER	LEVIER ROUE POST. GAUCHE	RADHEBEL L.
6	P4020020	1	LEVA ALZAR. POST. DX	RIGHT REAR WHEEL LEVER	LEVIER ROUE POST. DROITE	RADHEBEL R.
7	P4020029	2	PORTA RUOTA POSTER.	REAR WHEEL SUPPORT	SUPPORT ROUE ARRIÈRE	RADHALTER
8	1030002A1	2	BUSSOLA	BUSHING	DOUILLE	BÜCHSE
9	1020020A1	2	RONDELLA	WASHER	RONDELLE	SCHEIBE
10	1070001A1	2	SEGER	CIRCLIP	SEGER	SEGER
11	P1020050	2	RONDELLA	SPRING WASHER	RONDELLE ÉLASTIQUE	FEDERSCHEIBE
12	P2020088	2	DISTANZIALE	SPACER	RONDELLE	DISTANZBÜCHSE
13	P2020128	2	COPRIRUOTA ANTERIORE	WHEEL COVER	PROTECTION	ABDECKUNG
14	P2020082	2	CERCHIO ANTERIORE	FRONT HUB	JANTE ANT.	FELGE
15	P3030013	4	CUSCINETTO	BEARING	PALIER	LAGER
16	P2020083	2	COPERTONE	TYRE	PNEU	REIFEN
17	P00015176	2	RUOTA ANTERIORE	FRONT WHEEL ASS.Y	ROUE ANT. COMPL.	RAD KOMPL.
18	1020007A1	2	RONDELLA	WASHER	RONDELLE	SCHEIBE
19	1010018A1	2	VITE	SCREW	VIS	SCHRAUBE
20	P2020062	2	COPRIMOZZO	COVER	COUVERCLE	DECKEL

Ihr Ersatzteilspezialist im Internet

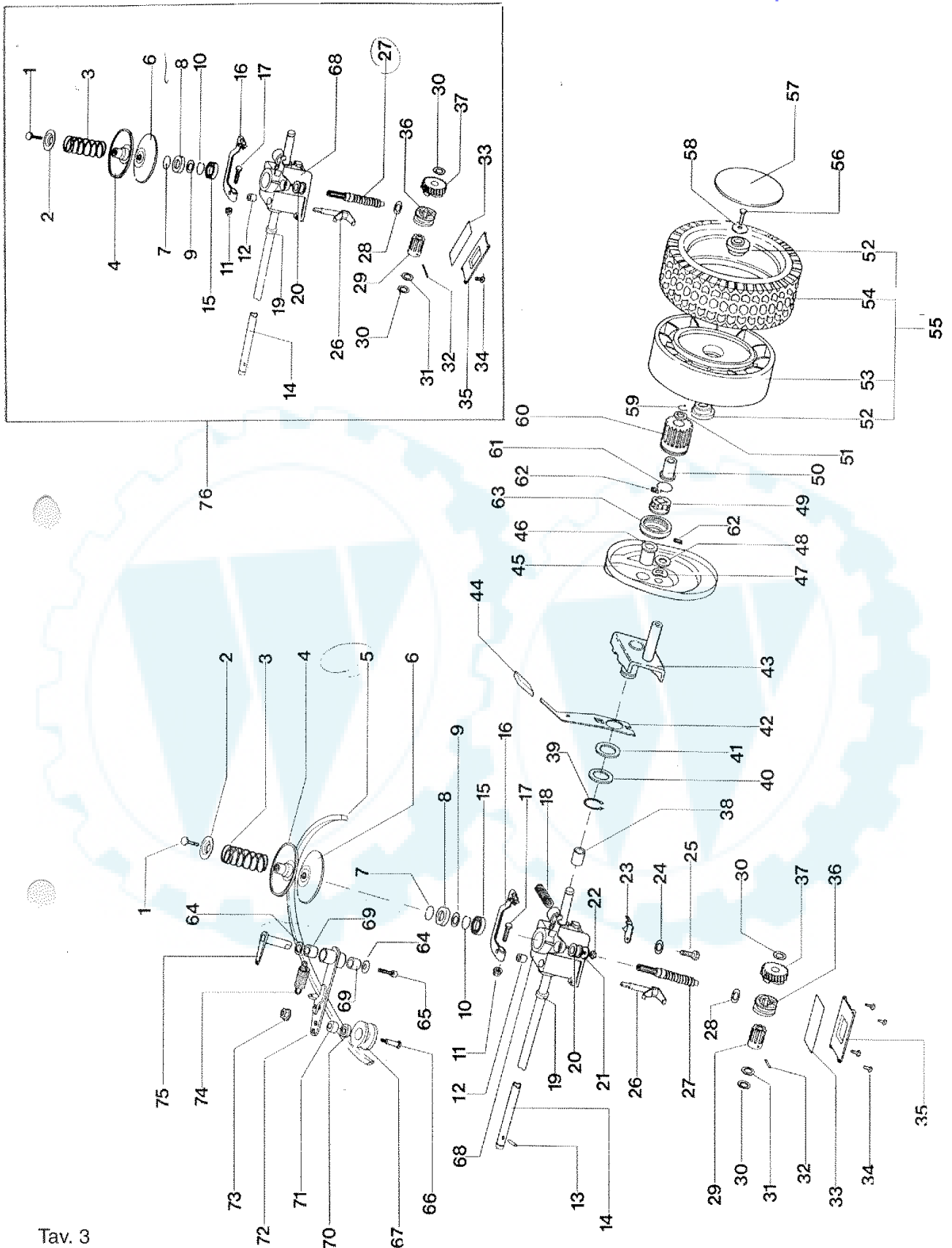

Tav. 3

Assale posteriore e trasmissione (vario speed)
Rear axle and gearbox (vario speed)
Essieu arrière et transmission (vario speed)
Hinterachse und Fahrgetriebe (vario speed)

	PART. N°	QTY	DESCRIZIONE	DESCRIPTION	DESCRIPTION	BESCHREIBUNG
1	P1010066	1	VITE	SCREW	VIS	SCHRAUBE
2	P4010044	1	RONDELLA	WASHER	RONDELLE	SCHEIBE
3	P3020032	1	MOLLA	SPRING	RESSORT	FEDER
4	P3040050	1	PULEGGIA	PULLEY	POULIE	RIEMENSCHLEIBE
5	P3010012	1	CINGHIA	BELT	COURROIRE	RIEMEN
6	P3040051	1	PULEGGIA	PULLEY	POULIE	RIEMENSCHLEIBE
7	P3170013	1	O-RING	SPACER	DOUILLE	ABSTANDSSTÜCK
8	P3170010	1	ANELLO DI TENUTA	OIL SEAL	JOINT D'ARBRE	WELLENDICHTRING
9	P1020051	1	RONDELLA	WASHER	RONDELLE	SCHEIBE
10	P1070004	1	SEEGER	CIRCLIP	SEEGER	SEEGER
11	1050003A1	1	DADO	NUT	ECROU	MUTTER
12	P3170012	1	ANELLO DI TENUTA	OIL SEAL	JOINT D'ARBRE	WELLENDICHTRING
13	P1080004	2	SPINA	PIN	GOUPILLE	STIFT
14	P3040075	1	ALBERO TRAZIONE	TRACTION SHAFT	ARBRE DE TRACTION	ANTRIEBSWELLE
15	P3030010	1	CUSCINETTO	BEARING	PALIER	LAGER
16	P4070011	1	LEVA TRAZIONE	TRACTION LEVER	LEVIER DE TRACTION	ANTRIEBSHEBEL
17	P1010075	1	VITE	SCREW	VIS	SCHRAUBE
18	P3020010	1	MOLLA	SPRING	RESSORT	FEDER
19	P3170012	2	ANELLO DI TENUTA	OIL SEAL	JOINT D'ARBRE	WELLENDICHTRING
20	P2040010	1	ANTIVIBRANTE	RUBBER TUBE	TUBE DE PROTECTION	SCHUTZHÜLLE
21	P1020054	1	RONDELLA	WASHER	RONDELLE	SCHEIBE
22	P1010073	1	VITE	SCREW	VIS	SCHRAUBE
23	P4030010	1	COPERCHIETTO	COVER	COUVERCLE	DECKEL
24	P1020055	1	RONDELLA	WASHER	RONDELLE	SCHEIBE
25	P1010076	1	VITE	SCREW	VIS	SCHRAUBE
26	P3040041	1	FORCELLA INNESTO	FORK	FOURCHE	GABEL
27	P3040043	1	VITE SENZA FINE	WORM GEAR	VIS SANS FIN	SCHNECKE
28	P1020053	1	RONDELLA	SPACER	DOUILLE	ABSTANDSSTÜCK
29	P3050030	1	BUSSOLA	BUSHING	DOUILLE CANNELEE	KEILHÜLSE
30	1020020A1	2	RONDELLA	WASHER	RONDELLE	SCHEIBE
31	P1020051	1	RONDELLA	WASHER	RONDELLE	SCHEIBE
32	P1080007	1	SPINA	PIN	GOUPILLE	STIFT
33	P3170014	1	O-RING	O-RING	JOINT TORIQUE	GUMMRING
34	P1010076	4	VITE	SCREW	VIS	SCHRAUBE
35	P4110001	1	COPERCHIO	COVER	COUVERCLE	DECKEL
36	P00038099	1	INNESTO	SELECTOR COLLAR	MANCHON	SCHALTBÜCHSE
37	P00038199	1	RUOTA ELICOIDALE	WORM WHEEL	ROUE POUR.VIS S. FIN	SCHNECKENRAD
38	3030003A1	2	CUSCINETTO	BEARING	PALIER	LAGER
39	P1070008	2	SEEGER	CIRCLIP	SEEGER	SEEGER
40	P1020058	2	RONDELLA	SPACER	DOUILLE	ABSTANDSSTÜCK
41	P1020057	2	RONDELLA	SPACER	DOUILLE	ABSTANDSSTÜCK
42	P4020019	1	LEVA ALZARUOTA POST. SX	LEFT REAR WHEEL LEVER	LEVIER ROUE POST. GAUCHE	RADHEBEL L.
42	P4020020	1	LEVA ALZARUOTA POST. DX	RIGHT REAR WHEEL LEVER	LEVIER ROUE POST. DROITE	RADHEBEL R.
43	P4020029	2	PORTA RUOTA POST.	REAR WHEEL SUPPORT	SUPPORT ROUE ARRIERE	RADHALTER
44	P2020077	2	POMELLO	KNOB	POIGNÉE	KNOPF
45	P4030011	2	COPRIRUOTA POSTERIORE	WHEEL COVER	PROTECTION	ABDECKUNG
46	P2020070	2	BOCCOLA	BUSHING	DOUILLE	BÜCHSE
47	P1020050	2	RONDELLA	SPRING WASHER	RONDELLE ELASTIQUE	FEDERSCHLEIBE
48	P2020088	2	DISTANZIALE	SPACER	RONDELLE	DISTANZBÜCHSE
49	P2100001	2	CAMME CRICCHETTO	CAMME DRIVER	CLIQUETTE DE CAMME	MITNEHMER
50	P2020059	2	BUSSOLA	BUSHING	DOUILLE	BÜCHSE
51	1020020A1	2	RONDELLA	WASHER	RONDELLE	SCHEIBE
52	P3030013	4	CUSCINETTO	BEARING	PALIER	LAGER
53	P2020084	2	CERCHIO POSTERIORE	REAR HUB	FRETTE ARRIERE	HINTERFELGE
54	P2020083	2	COPERTONE	TYRE	PNEU	REIFEN
55	P00015276	2	RUOTA POSTERIORE	REAR WHEEL	ROUE ARRIERE	HINTERRAD
56	1010018A1	2	VITE	SCREW	VIS	SCHRAUBE
57	P2020062	2	COPRIMOZZO	COVER	COUVERCLE	DECKEL
58	1020007A1	2	RONDELLA	WASHER	RONDELLE	SCHEIBE
59	1070001A1	2	SEEGER	CIRCLIP	SEEGER	SEEGER
60	P3050031	2	RUOTA DENTATA	PINION	PIGNON	RITZEL
61	P3020012	2	MOLLA	SPRING	RESSORT	FEDER
62	P2110001	4	SALTARELLO	KEY	CLAVETTE	SCHEIBENFEDER
63	P2020060	2	COPRIPIGNONE	CAGE	CAGE	KÄFIG
64	1020020A1	2	RONDELLA	WASHER	RONDELLE	SCHEIBE
65	P1010074	1	VITE	SCREW	VIS	SCHRAUBE
66	P3040068	1	PERNO	PIN	GOUPILLE	STIFT
67	P3040063	1	PULEGGIA	PULLEY	POULIE	RIEMENSCHLEIBE
68	P00039199	1	SCATOLA RIDUTTORE	GEARBOX HOUSING	BOÎTE DE VITESSE	GETRIEBE
69	1030002A1	2	BUSSOLA	BUSHING	DOUILLE	BÜCHSE
70	P3030014	1	CUSCINETTO	BEARING	PALIER	LAGER
71	P3040064	1	DISTANZIALE	SPACER	ENTRETOISE	DISTANZBÜCHSE
72	P4010040	1	TENDICINGHIA	BELT TENSIONER	TENDEUR DE COURROIRE	RIEMENSCHLEIBER
73	P1050011	1	DADO	NUT	ECROU	MUTTER
74	P3020033ZT	1	MOLLA	SPRING	RESSORT	FEDER
75	P4010041	1	PERNO	PIN	GOUPILLE	STIFT
76	P2090002	1	RIDUTTORE COMPL.	GEAR BOX ASS.Y	RÉDUCTEUR COMPL.	FAHRGETRIEBE KOMP.

770011

Tav. 4

Stegola superiore e comandi (a spinta)
Upper handle and controls (push model)
Guidon supérieur et éléments de commande (à pousser)
Lenkeroberteil und Bedienungselemente (handgestoßen)

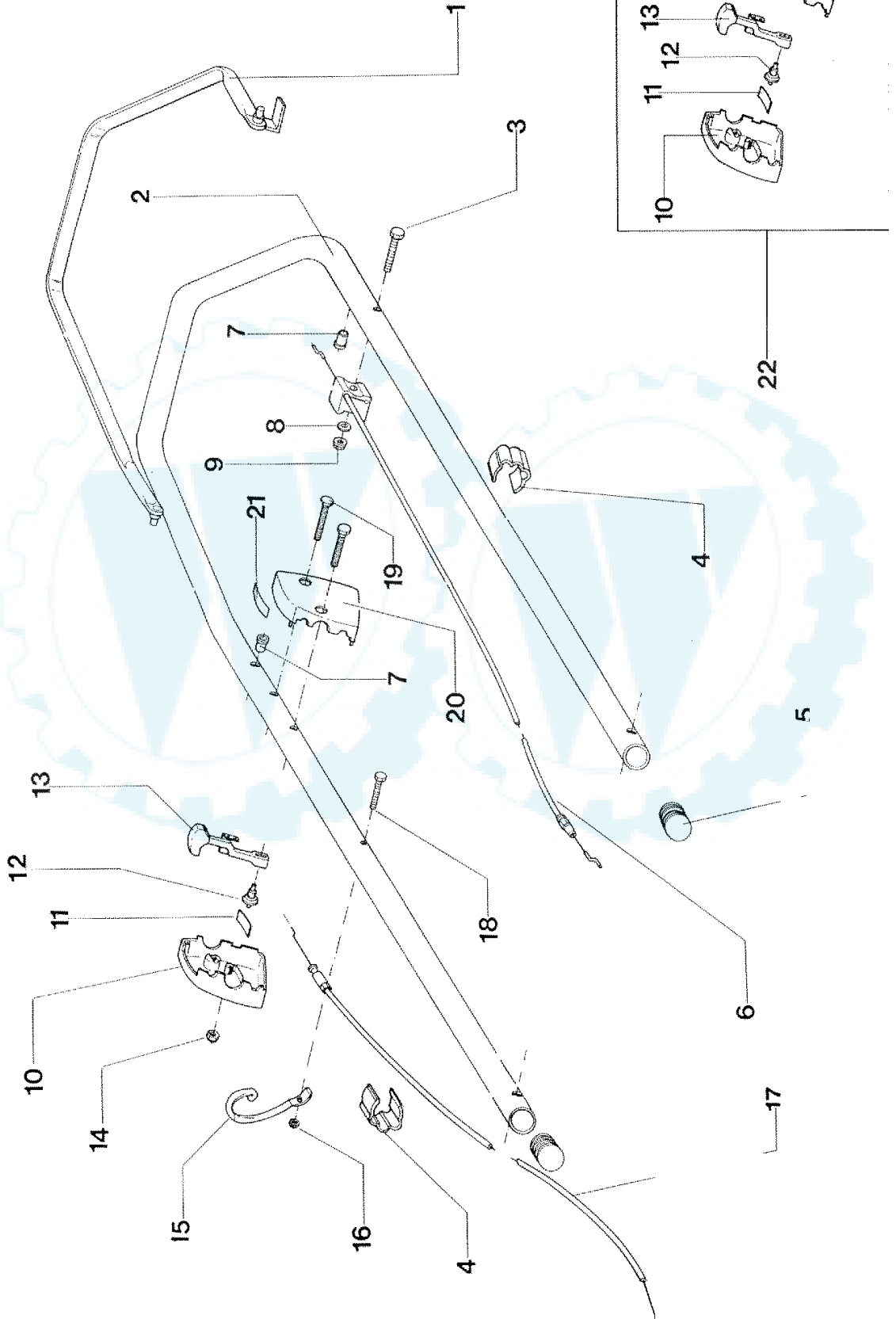

www.ersatzteil-service.de

www.ersatzteilplan.de

	PART. N°	QTY	DESCRIZIONE	DESCRIPTION	DESCRIPTION	BESCHREIBUNG
1	P4080037VE	1	MANIGLIA SYSTEM 2	SYSTEM 2 LEVER	LEVIER SYSTEM 2	SYSTEM 2 HEBEL
2	P3120105VE	1	STEGOLA SUP.	UPPER HANDLEBAR	GUIDON SUPÉRIEUR	D. FÜHRUNGSHOLM
3	P1010203	1	VITE	SCREW	VIS	SCHRAUBE
4	P2020080	2	FERMA CAVO	CLIP	CLIP	HALTER
5	P2020142	2	TAPPO	PLUG	BOUCHON	PFROPFEN
6	P5010060	1	CAVO	CABLE	CABLE	KABEL
7	P3040123	2	BUSSOLA	BUSHING	DOUILLE	BÜCHSE
8	1020013A1	1	RONDELLA	WASHER	RONDELLE	SCHEIBE
9	1050003A1	1	DADO	NUT	ECROU	MUTTER
10	P2020374	1	SCATOLA ACCELERATORE	THROTTLE HOUSING	BOÎTE DE GAZ	GASGEHÄUSE
11	P4010059	2	MOLLA	SPRING	RESSORT	FEDER
12	P2020108	1	NOTTOLINO	BOLT	BOULON	STIFT
13	P00065099	1	LEVA ACCELERATORE	THROTTLE LEVER	LEVIER DE COMMANDE	GASHEBEL
14	1050003A1	1	DADO	NUT	ECROU	MUTTER
15	P01068343	1	SUPPORTO	STARTER HOLDER	SUPPORT	HALTER
16	1050002A1	1	DADO	NUT	ECROU	MUTTER
17	P5020066	1	CAVO ACCELERATORE	THROTTLE CABLE	CÂBLE DE GAZ	GASKABEL
18	1010002A1	1	VITE	SCREW	VIS	SCHRAUBE
19	P1010102	2	VITE	SCREW	VIS	SCHRAUBE
20	P2020375	1	SCATOLA ACCELERATORE	THROTTLE HOUSING	BOÎTE DE GAZ	GASGEHÄUSE
21	P5140552	1	DECALCO	DECAL	MARQUAGE	AUFKLEBER
22	P3060052	1	SCATOLA ACCEL. COMPL	THROTTLE HOUSING ASS.Y	BOÎTE DE GAS COMPL.	GASGEHÄUSE KOMPL.

Ihr Ersatzteilspezialist im Internet

Tav. 5

Stegola superiore e comandi (vario speed)
Upper handle and controls (vario speed)
Guidon supérieur et éléments de commande (vario speed)
Lenkeroberteil und Bedienungselemente (vario speed)

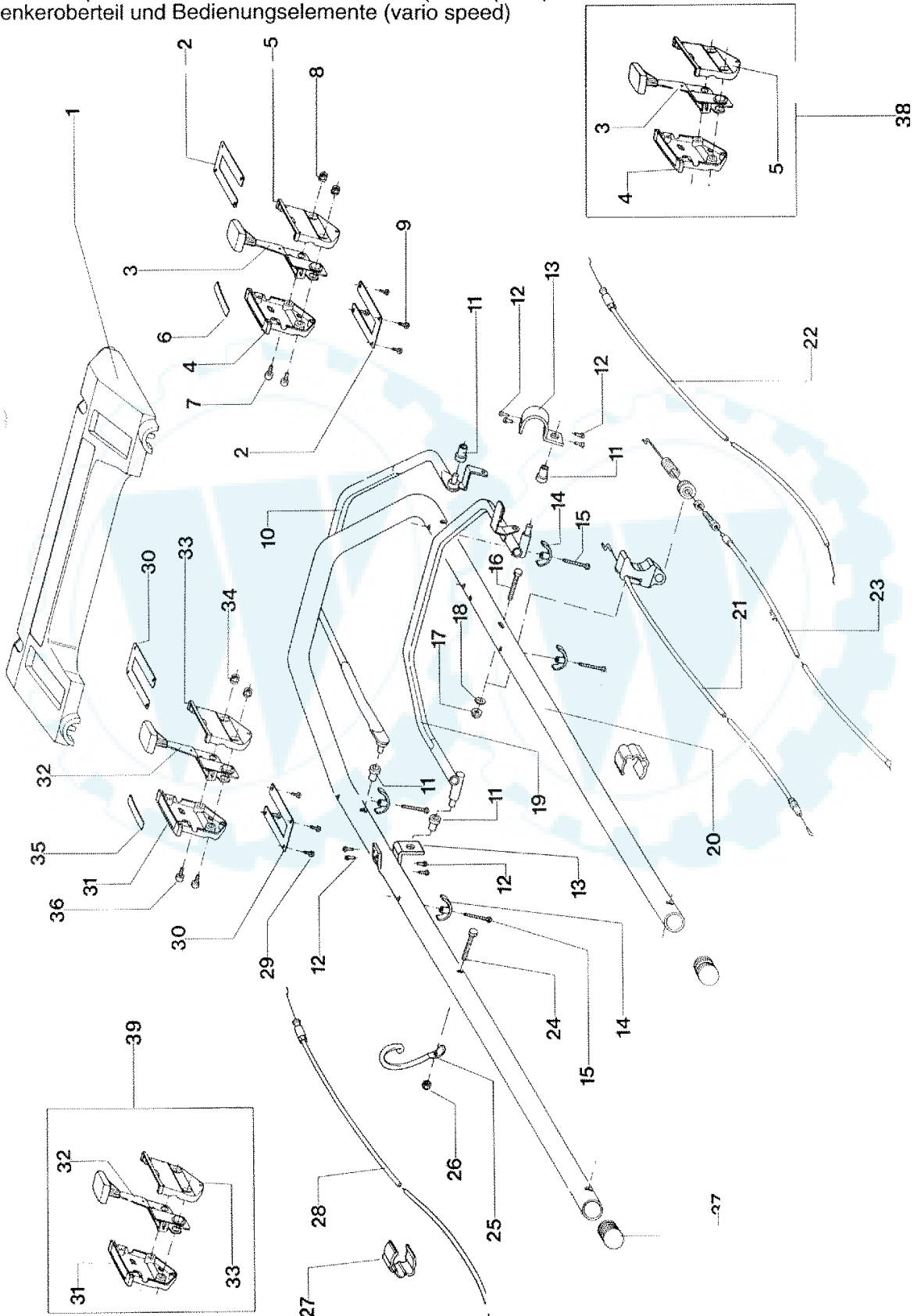

REF. N°	PART. N°	QTY	DESCRIZIONE	DESCRIPTION	DESCRIPTION	BESCHREIBUNG
1	P2020364	1	TRAVERSINO	CONTROL PANEL	PANNEAU DE CONTRÔLE	SCHALTAFEL
2	P4010217ZT	2	SOSTEGNO	SUPPORT	SUPPORT	HALTER
3	P3090008	1	LEVA VARIATORE	SPEED VARIATOR LEVER	LEVIER DE VITESSE	HEBEL (GESCHWINDIGKEIT)
4	P2020366	1	SEMISCATOLA DX	HALF HOUSING, R.H.	SEMI-BOÎTE DROITE	HALBGEHÄUSE, R.
5	P2020365	1	SEMISCATOLA SX	HALF HOUSING, L.H.	SEMI-BOÎTE GAUCHE	HALBGEHÄUSE, L.
6	P5140548	1	DECALCO	DECAL	MARQUAGE	AUFKLEBER
7	P1010207	2	VITE	SCREW	VIS	SCHRAUBE
8	1050002A1	2	DADO	NUT	ÉCROU	MUTTER
9	P1010205	4	VITE	SCREW	VIS	SCHRAUBE
10	P4080033VE	1	MANIGLIA SYSTEM 2	SYSTEM 2 LEVER	LEVIER SYSTEM 2	SYSTEM 2 HEBEL
11	P3040123	4	BUSSOLA	BUSHING	DOUILLE	BÜCHSE
12	P1020106	8	RIVETTO	RIVET	RIVET	NIET
13	P4010222ZN	2	SUPPORTO	SUPPORT	SUPPORT	HALTER
14	P2020369	4	CAVALLOTTO	RETAINER	ARRÊT	HALTER
15	P1010204	4	VITE	SCREW	VIS	SCHRAUBE
16	P1010203	1	VITE	SCREW	VIS	SCHRAUBE
17	1050003A1	1	DADO	NUT	ÉCROU	MUTTER
18	1020013A1	1	RONDELLA	WASHER	RONDELLE	SCHIBE
19	P4080034VE	1	MANIGLIA TRAZIONE	TRACTION LEVER	LEVIER DE TRACTION	ANTRIEBSHEBEL
20	P3120094VE	1	STEGOLA SUPERIORE	UPPER HANDLEBAR	GUIDON SUPÉRIEUR	OB. FÜHRUNGSHOLM
21	P5010051	1	CAVO SYSTEM 2	SYSTEM 2 CABLE	CÂBLE SYSTEM 2	SYSTEM 2 KABEL
21	P5010064	1	CAVO SYSTEM 2 (5342F)	SYSTEM 2 CABLE (5342F)	CÂBLE SYSTEM 2 (5342F)	SYSTEM 2 KABEL (5342F)
22	P5010057	1	CAVO VARIATORE	SPEED VARIATOR CABLE	CÂBLE DE VITESSE	KABEL (GESCHWINDIGKEIT)
23	P5010058	1	CAVO TRAZIONE	TRACTION CABLE	CÂBLE DE TRACTION	ANTRIEBSKABEL
24	1010002A1	1	VITE	SCREW	VIS	SCHRAUBE
25	P01068343	1	SUPPORTO	STARTER HOLDER	SUPPORT	HALTER
26	1050002A1	1	DADO	NUT	ÉCROU	MUTTER
27	P2020080	2	FERMA CAVO	CLIP	CLIP	HALTER
28	P5020066	1	CAVO ACCELERATORE	THROTTLE CABLE	CÂBLE DE GAZ	GASKABEL
28	P5020071	1	CAVO ACCELER. (5342F)	THROTTLE CABLE (5342F)	CÂBLE DE GAZ (5342F)	GASKABEL (5342F)
29	P1010205	4	VITE	SCREW	VIS	SCHRAUBE
30	P4010217ZT	2	SOSTEGNO	SUPPORT	SUPPORT	HALTER
31	P2020366	1	SEMISCATOLA DX	HALF HOUSING, R.H.	SEMI-BOÎTE DROITE	HALBGEHÄUSE, R.
32	P3090006	1	LEVA ACCELERATORE	THROTTLE LEVER	LEVIER DE GAZ	GASHEBEL
33	P2020365	1	SEMISCATOLA SX	HALF HOUSING, L.H.	SEMI-BOÎTE GAUCHE	HALBGEHÄUSE, L.
34	1050002A1	2	DADO	NUT	ÉCROU	MUTTER
35	P5140547	1	DECALCO	DECAL	MARQUAGE	AUFKLEBER
36	P1010207	2	VITE	SCREW	VIS	SCHRAUBE
37	P2020142	2	TAPPO	PLUG	BOUCHON	PFROPFEN
38	P3080005	1	SCATOLA VARIAT. COMPL.	SPEED VAR. HOUSING ASS.Y	BOÎTE DE VITESSE COMPL.	KABEL KOMP. (GESCHWINDIGKEIT)
39	P3080004	1	SCATOLA ACC. COMPL.	THROTTLE HOUSING ASS.Y	BOÎTE DE GAZ COMPL.	GASKABEL KOMP.

Tav. 6

Stegola superiore e comandi (vario speed, avviamento elettrico)

Upper handle and controls (vario speed, electric start)

Guidon supérieur et éléments de commande (vario speed, démarrage électrique)

Lenkeroberteil und Bedienungselemente (vario speed, Elektrostarter)

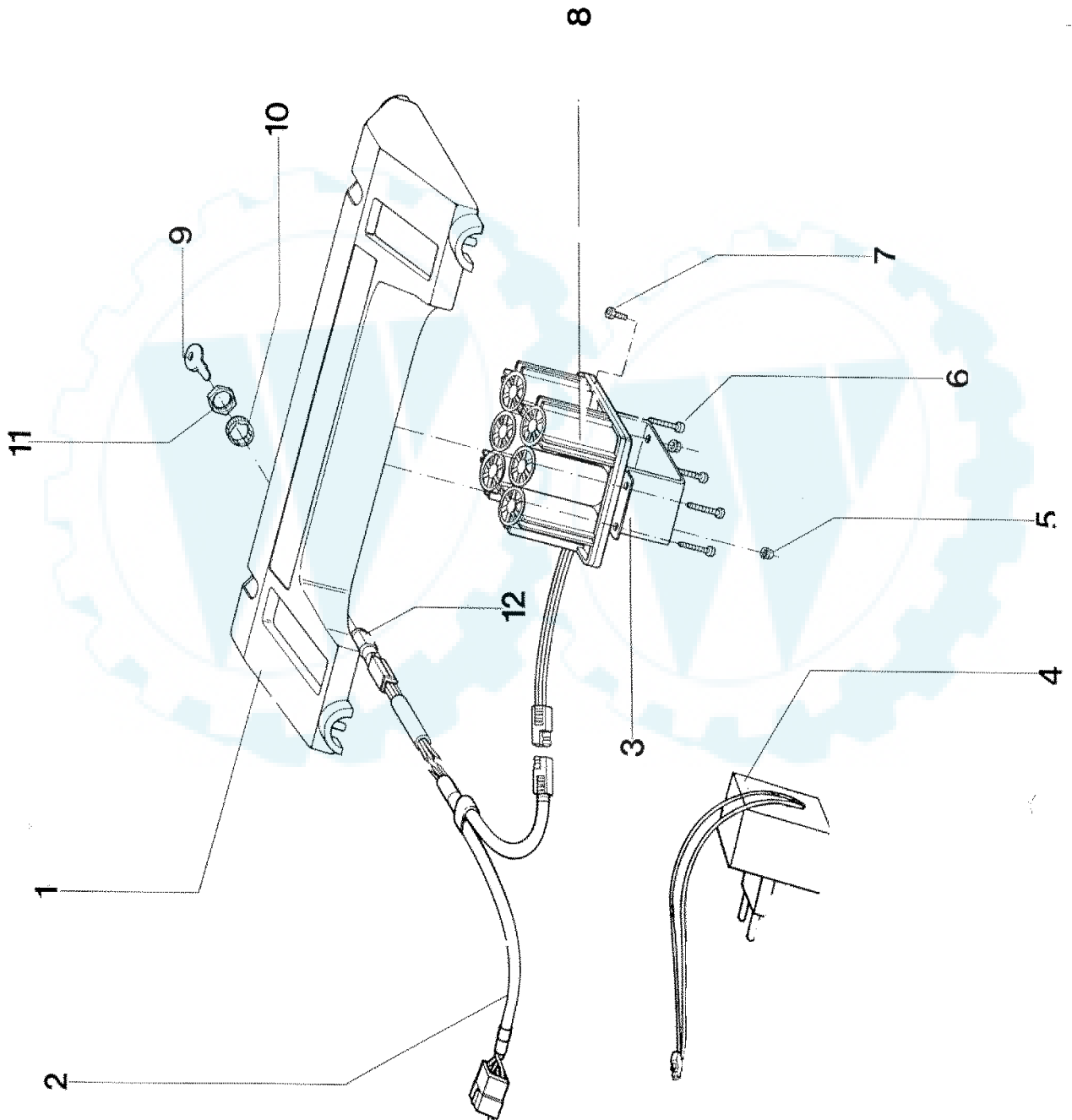

www.ersatzteil-service.de

www.ersatzteilplan.de

REF. N°	PART. N°	QTY	DESCRIZIONE	DESCRIPTION	DESCRIPTION	BESCHREIBUNG
1	P2020064	1	PANNELLO DI CONTROLLO	CONTROL PANEL	PANNAU DE CONTROL	SCHWELTAFEL
2	P4200018	1	CAVETTO FIBRICO	WIRE	CABE ELECTROUT	KABEL
3	P4010025794	1	SCATTA	SUPPORT	SUPPORT	HALTER
4	P4200009	1	CARICA BATTERIA	BATTERY CHARGER	CHARGEUR	LADGERAT
5	1050009A1	2	DIAMO	NUT	DIAMU	MUTTER
6	P1210005	4	VITE	SCREW	VE	SCHRAUBE
7	P1210007	2	VITE	SCREW	VE	SCHRAUBE
8	P4200000	1	BATTERIA	BATTERY	BATTERIE	BATTERIE
9	P4200011	2	CHIAVE	KEY	CLAVETTE	SCHLÜSSEL
10			VED. RC 12	SEE REF. 12	VOIR REF. 12	SEH REF. 12
11			VED. RC 12	SEE REF. 12	VOIR REF. 12	SEH REF. 12
12	1444000	1	BOOK CHARGING COMPLETE	RECHARGE	RECHARGEUR	MOBILF. LADGERAT

Ihr Ersatzteilspezialist im Internet

Tav. 1

Vista generale
Complete machine
Vue d'ensemble
Gesamtansicht

