

ERSATZTEILLISTE

**ECHO Laub- und Abfallsauger
mit Antrieb**

ES-330B-02

**ECHO-Motorgeräte
Vertrieb Deutschland GmbH
Otto-Schott-Straße 7**

72555 Metzingen

**Telefon 07123-1091
Telefax 07123-2589
<http://www.echo-shop.de>
email: info@echo-shop.de**



ES-330B-02

Führungsholm, Getriebe **Abb. 1**

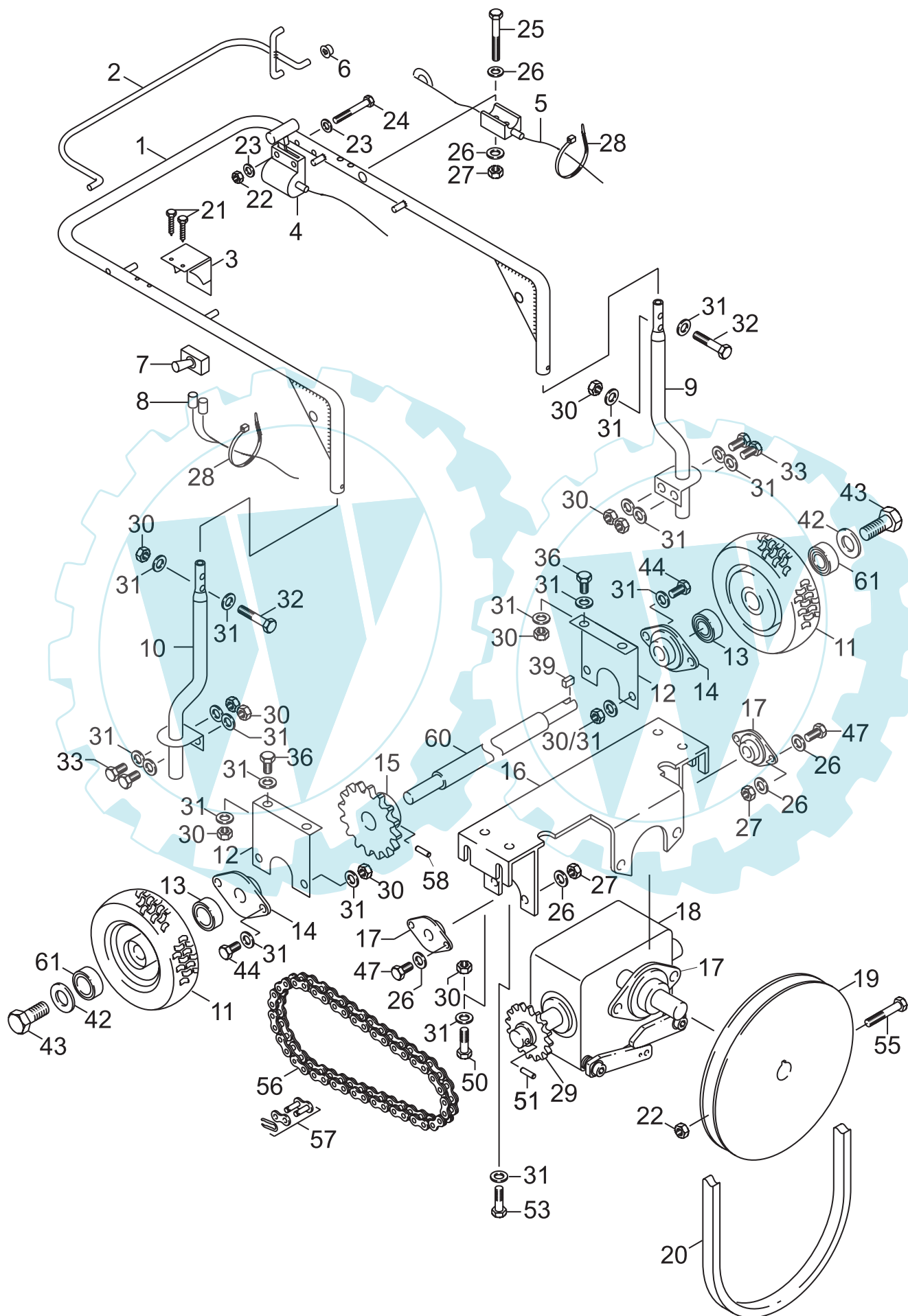

ES-330B-02



Baugruppe Führungsholm Getriebe			
Bild	Ersatzteilnummer	Beschreibung	Menge
1	36-10-0008-0	Führungsholm	1
2	38-WA-040-00	Kupplungsbügel	1
3	38-50-0002-0	Halter Stoppschalter	1
4	38-WB-254-00	Gaszug	1
5	38-WB-255-00	Kupplungszug	1
6	38-WB-276-00	Clip Kupplungszug	1
7	36-50-0004-0	Stopschalter	1
8	38-WB-256-00	Kabelbaum	1
9	36-10-0009-0	Führungsholmträger links	1
10	36-10-0010-00	Führungsholmträger rechts	1
11	36-15-0002-0	Rad komplett 3,5 "	2
	bestehend aus		
	36-15-0007-0	Mantel 3,5 "	2
	36-15-0009-0	Schlauch 3,5 "	2
11	36-15-0006-0	Rad komplett 4 "	2
	bestehend aus		
	36-15-0008-0	Mantel 4 "	2
	36-15-0010-0	Schlauch 4 "	2
12	36-10-0011-0	Halter Hinterachse	2
13	36-90800-62042	Radkugellager 6204 2RS	2
14	36-00-0007-0	Yet Lager SB 204 komplett	2
15	36-15-0011-0	Zahnrad Hinterachse	1
16	36-15-0012-0	Getrieberahmen	1
17	36-00-0004-0	Yet Lager SB 201 komplett	3
18	36-15-0004-0	Getriebe	1
19	36-85-0002-0	Getrieberiemenscheibe	1
20	36-95-0002-0	Keilriemen	1
21	36-90150-05020	Inbusschraube	2
22	36-90650-00005	Mutter M5, selbstsichernd	2
23	36-90700-00005	U Scheibe M5	4
24	36-90100-05065	Schraube M 5x65	2
25	36-90100-06060	Schraube M 6x60	1
26	36-90700-00006	U Scheibe M6	6
27	36-90650-00006	Mutter M6, selbstsichernd	3
28	36-90920-00011	Kabelbinder	4
29	36-15-0005-0	Kettenrad, klein, Getriebe	1
30	36-90650-00008	Mutter M8, selbstsichernd	28
31	36-90700-00008	U Scheibe M8	56
32	36-90100-08045	Schraube M8x45	4
33	36-90100-08020	Schraube M8x20	8
36	36-90100-08025	Schraube M8x25	4
39	36-90500-06020	Paßfeder	2
42	36-90700-00010	Karosseriescheibe M10x30	2
43	36-90100-10025	Schraube M10x25	2
44	36-90160-08025	Schloßschraube M8x25	4
47	36-90160-06016	Schloßschraube M6x16	6
50	36-90100-08030	Schraube M 8x30	2
51	36-90310-04020	Spannstift 4x20	1
53	36-90100-08035	Schraube M8x35	2
55	36-90100-05060	Schraube M 5x60	1
56	36-15-0014-0	Antriebskette	1
57	36-15-0015-0	Kettenschloß komplett	1
58	36-90310-06060	Spannstift 6x60	1
60	36-10-0012-0	Hinterachse	1
61	36-90100-16041	Sperrlager BB20-1K-2GD	2



ES-330B-02

Fahrgestell **Abb. 2**

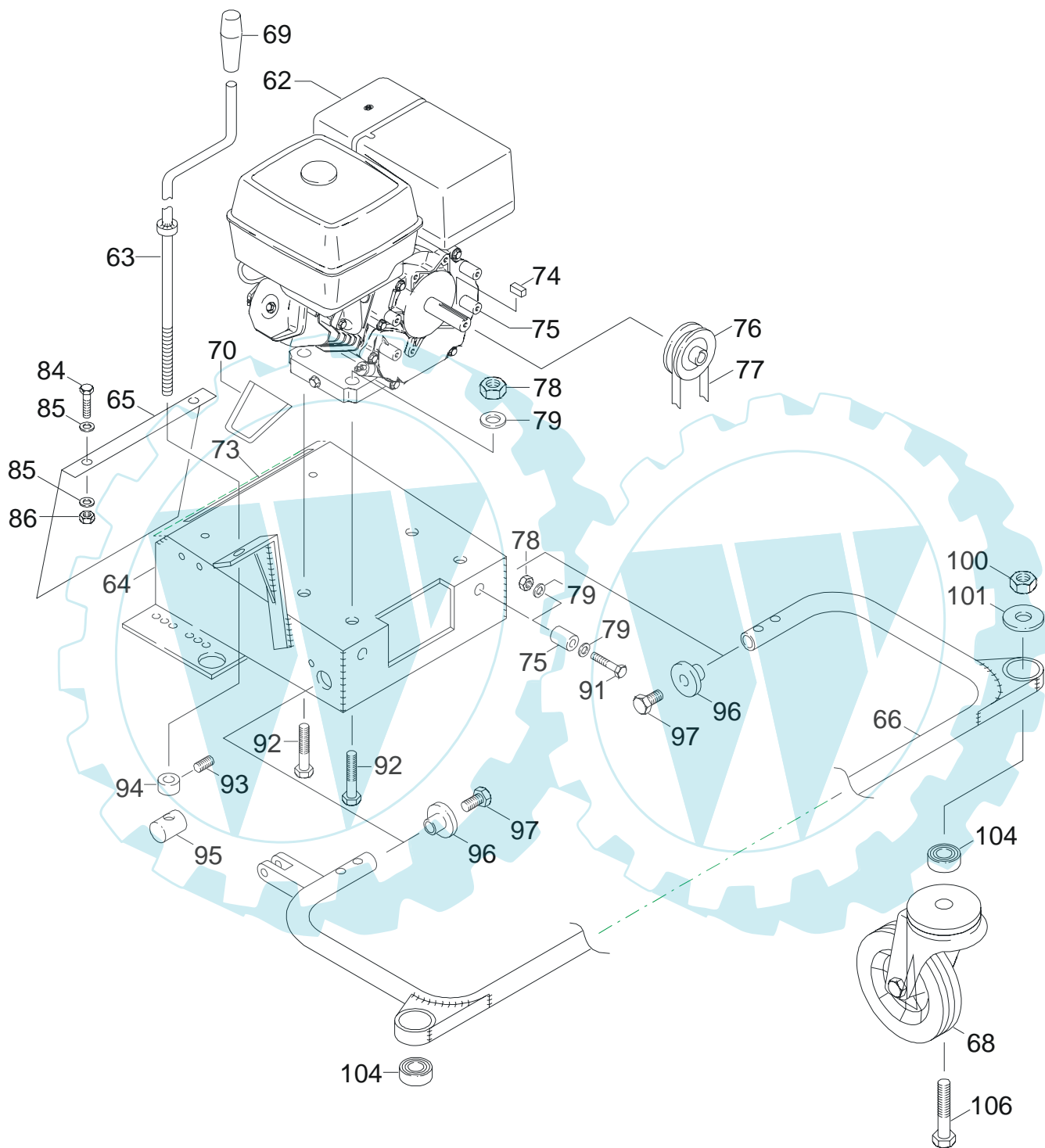

ES-330B-02



Baugruppe Fahrgestell			
Bild	Ersatzteilnummer	Beschreibung	Menge
62		Motor	1
63	36-25002-00121	Kurbel Höhenverstellung	1
64	36-10-0013-0	Grundrahmen	1
65	36-10-0014-0	Schutzblech	1
66	36-10-0007-0	Vorderachsrahmen	1
68	36-15-0016-0	Vorderrad komplett	2
69	36-20-0007-0	Griff Höhenverstellung	1
70	38-30-0001-0	Ölleitblech	1
73	36-60-0006-0	Sicherheitsaufkleber	1
74	38-WB-247-00	Paßfeder Motor	1
75	38-80-0017-0	Distanzhülse	4
76	38-WA-139-00	Motorriemenscheibe	1
77	36-95-0002-0	Keilriemen	1
78	36-90650-00008	Mutter M8, selbstsichernd	4
79	36-90700-00008	U Scheibe U8	8
84	36-90100-06016	Schraube M6x16	2
85	36-90700-00006	U Scheibe U6	4
86	36-90650-00006	Mutter M6, selbstsichernd	2
91	36-90100-08040	Schraube M8x40	2
92	36-90100-08030	Schraube M8x30	4
93	36-90150-10041	Madenschraube M5x6	1
94	38-WA-053-00	Lager Höhenverstellung	1
95	38-80-0020-0	Gewindebolzen	1
96	36-10-0015-0	Rohreinsatz	2
97	36-90100-10030	Schraube M10x30	2
100	36-90650-00012	Mutter M12, selbstsichernd	2
101	36-90700-00012	U Scheibe U12	2
104	36-10-0016-0	Radaufnahme	2
106	36-90100-12065	Schraube M12x65	2



ES-330B-02

Turbine, Gehäuse, Fangsack **Abb. 3**

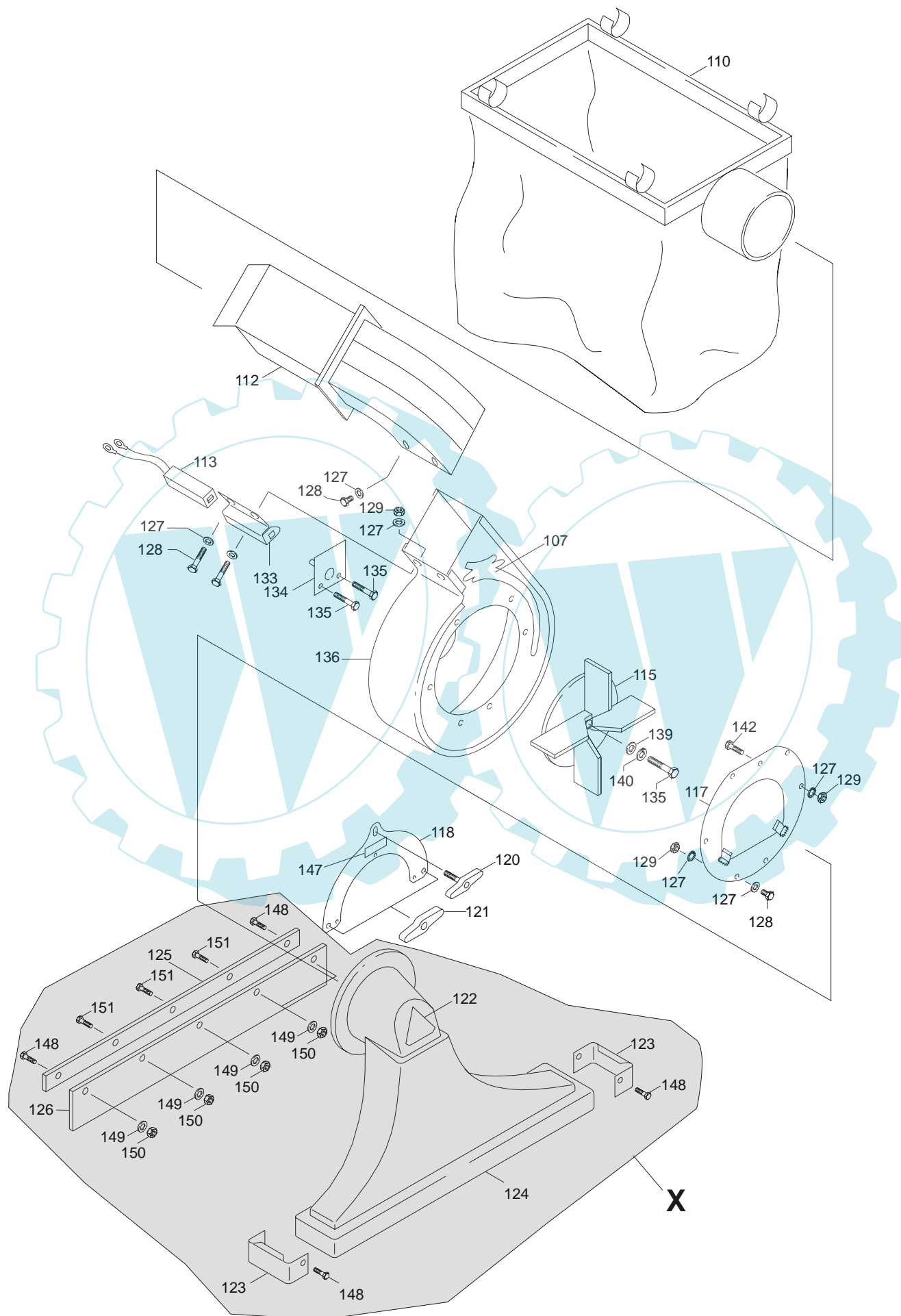

ES-330B-02



Baugruppe Turbine, Gehäuse, Fangsack			
Bild	Ersatzteilnummer	Beschreibung	Menge
107	36-60-0005-0	Aufkleber ES 330	1
110	Z-7500-002-00	Trockenfangsack (Serie)	1
	Z-7500-200-00	Naßfangsack (Zubehör)	1
112	38-WA-101-00	Auswurfbogen	1
113	37-540005800	Sicherheitsschalter	1
115	38-WA-102-00	Turbine	1
117	38-WA-010-00	Anflanschring	1
118	38-WA-107-00	Gegenhalter Saugrüssel	1
120	38-80-0006-0	Flügelschraube M8	1
121	38-WB-321-00	Flügelmutter M8	2
122	38-WB-280-00	Echo Aufkleber	1
123	38-35-0001-0	Kantenschutz	2
124	38-WB-253-00	Saugrüssel	1
125	38-WA-025-00	Klemmleiste	1
126	38-WB-251-00	Gummileiste	1
127	36-90700-00008	U Scheibe U8	20
128	36-90100-08020	Schraube M8x20	10
129	36-90650-00008	Mutter M8, selbstsichernd	10
133	38-25-0001-0	Halter Sicherheitsschalter	1
134	38-WA-149-00	Riemenführungsblech	1
135	38-WB-228-00	Schraube 5/16UNF. 1,12"	3
136	38-WA-103-00	Turbinengehäuse	1
139	38-WB-541-00	U Scheibe Turbine gewölbt	1
140	36-90700-54019	Zahnscheibe M8	1
142	36-90100-08030	Schraube M8x30	2
147	36-60-0007-0	Aufkleber, Modell, ES-330	1
148	36-90100-06025	Schraube M6x25	10
149	36-90700-00006	U Scheibe U6	12
150	36-90650-00006	Mutter M6, selbstsichernd	6
151	36-90100-06020	Schraube M6x20	3
X	38-WB-253-10	Saugrüssel kpl.	



ES-330B-02

Saugschlauch **Abb. 4**

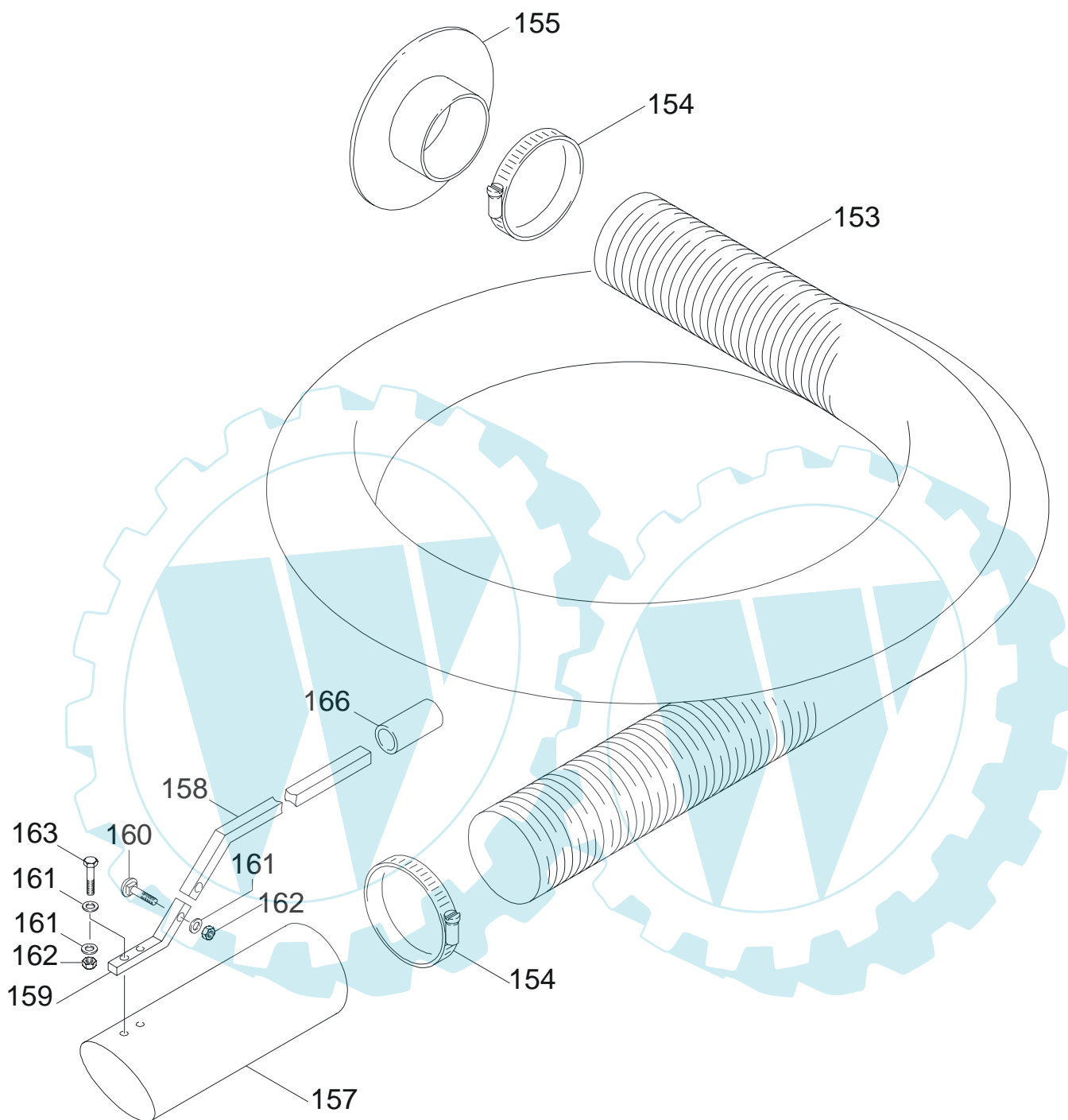

ES-330B-02



<u>Baugruppe Saugschlauch</u>			
Bild	Ersatzteilnummer	Beschreibung	Menge
153	20-9A-1399	Saugschlauch 140mm	1
154	20-9-1371	Schlauchklemme 140mm	2
155	38-WA-131-00	Anschlußflansch	1
157	38-WA-130-00	Saugnase	1
158	38-WA-128-00	Haltegriff Oberteil	1
159	38-WA-129-00	Haltegriff Unterteil	1
160	36-90100-06035	Schraube M6x35	1
161	36-90700-00006	U Scheibe U6	6
162	36-90650-00006	Mutter M6	3
163	36-90100-06020	Schraube M6x20	2
166	38-WB-322-00	Griffstück	1

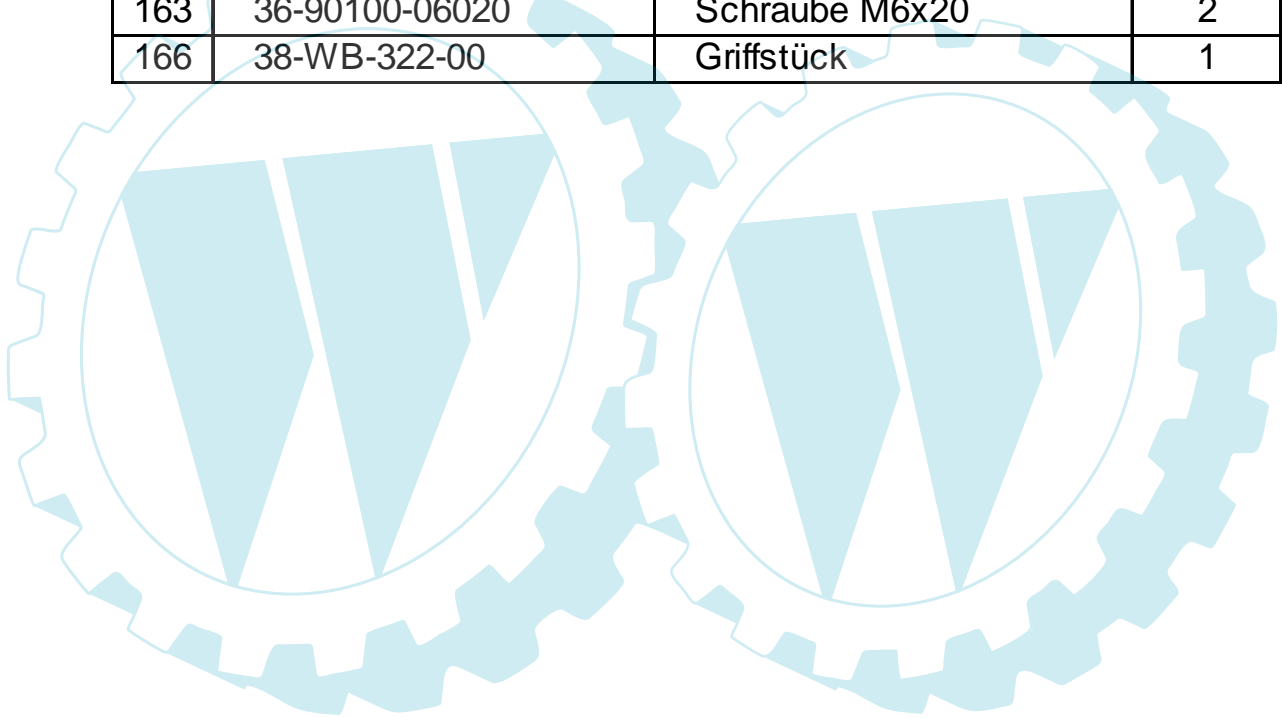





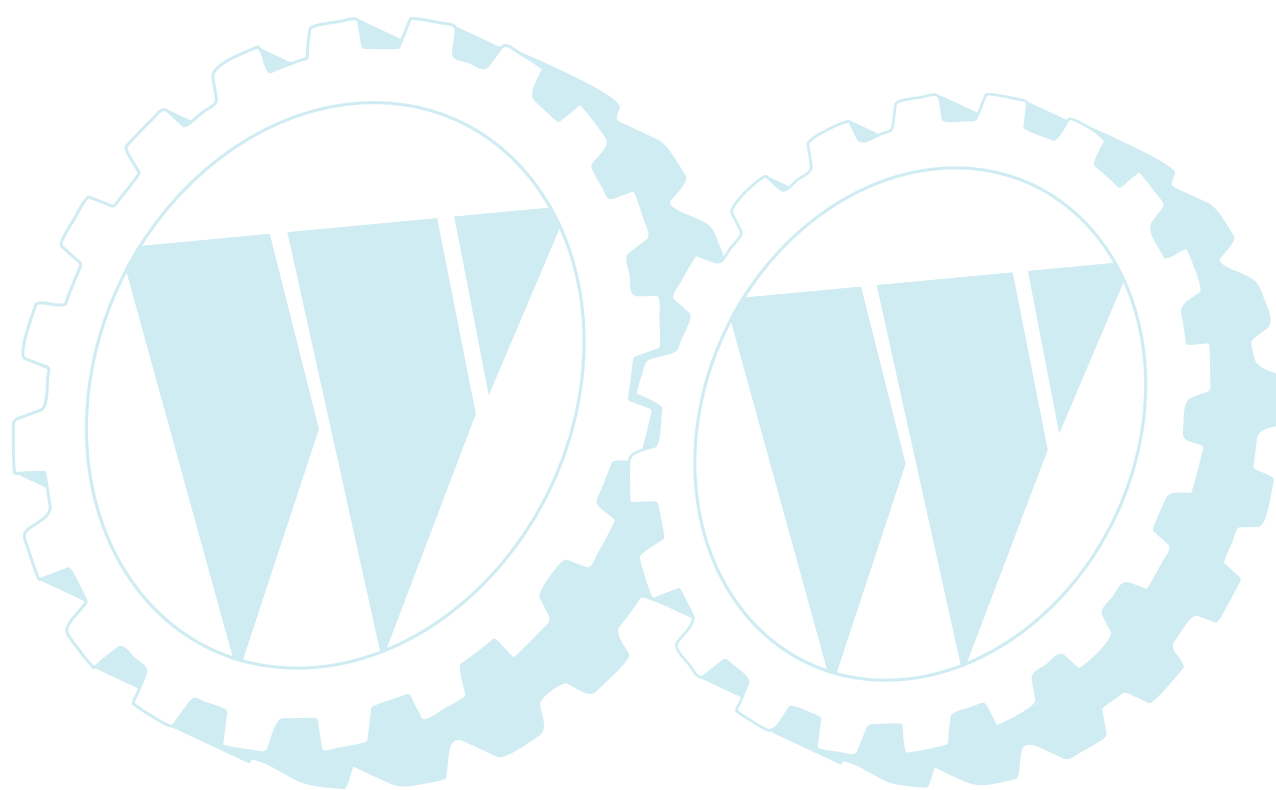



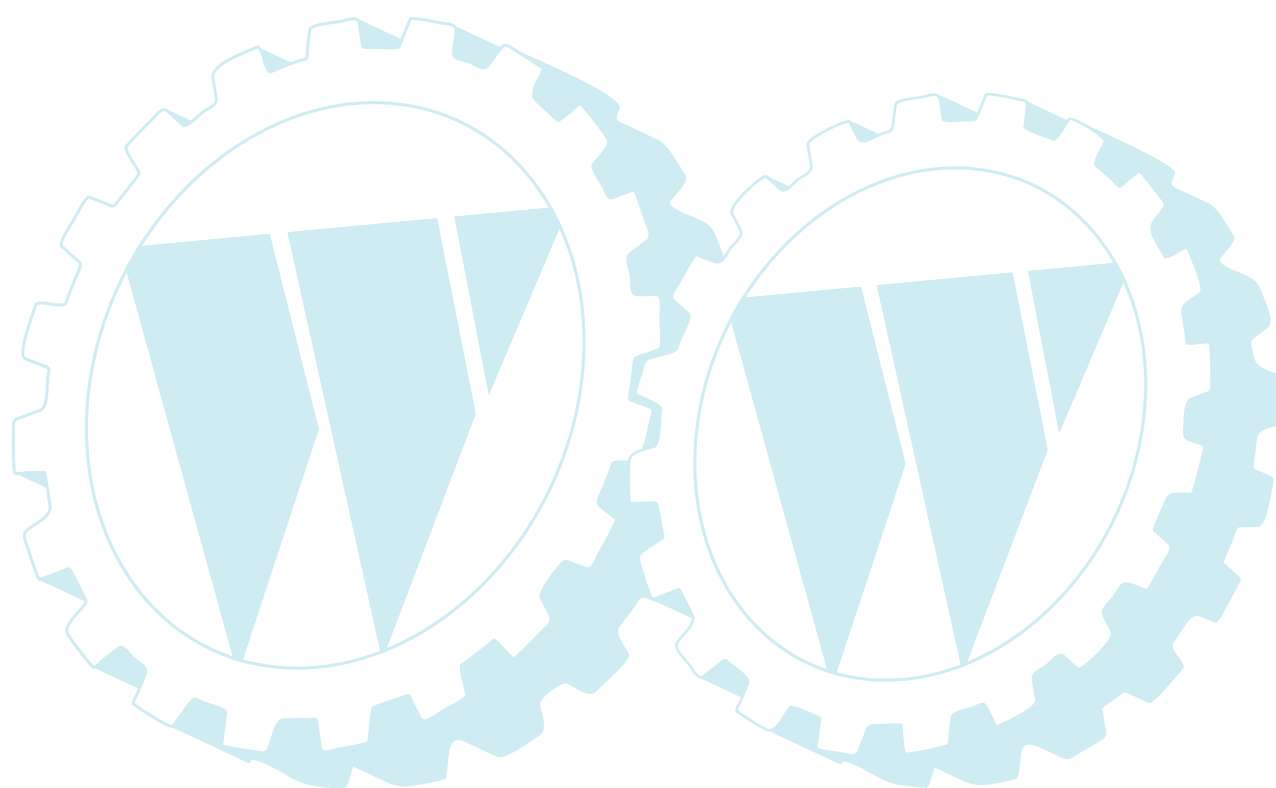



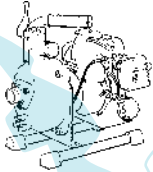

ES-330B-02



ES-330B-02

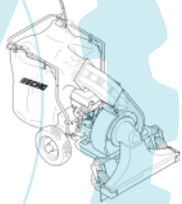

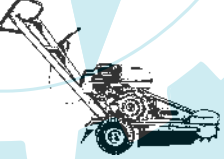
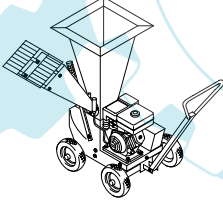
Wir bezeichnen uns als die besten Spezialisten für Pflorgetechnik im Aussenbereich zwischen 1.000 m² und 20.000 m² mit einer hervorragenden Serviceorganisation.

 Motorsägen	 Trennschneider	 Wasserpumpen	 Rückenspritze	 Bohrgerät
 Hochentaster	 Motorsensen	 Heckenscheren	 Blasgeräte	 Laubsauger
 Großbläser	 Stumpenfräse	 Häckselwölfe	 Rasentraktoren	 Kehrmaschinen

Grundstückspflege ist unsere Stärke

überreicht durch: