

ERSATZTEILLISTE

ECHO Laubbläser

EB-913

ab Seriennummer 0190086

**ECHO-Motorgeräte
Vertrieb Deutschland GmbH
Otto-Schott-Straße 7**

72555 Metzingen

**Telefon 07123-1091
Telefax 07123-2589
<http://www.echo-shop.de>
email: info@echo-shop.de**



EB-913

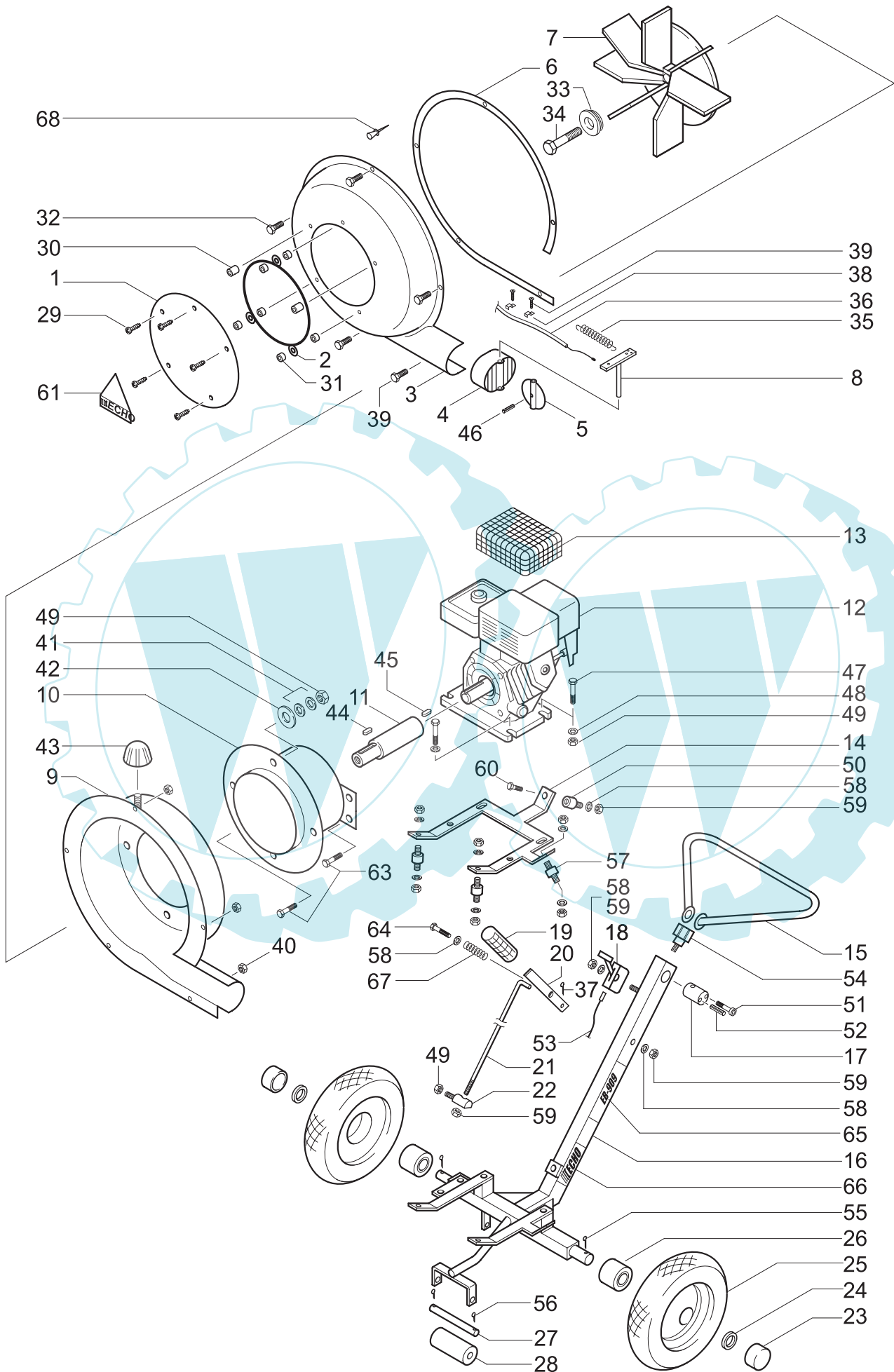

EB-913



Bild	Artikelnummer	Bezeichnung	Menge
1	36-35002-00070	Schutzplatte	1
2	36-35002-00060	Schutzring EB	1
3	36-35002-00020	Turbinengehäuse EB-909/913	1
4	36-35002-00040	Blasdüse m. Gitterstäben	1
5	36-25002-00080	Schwenkteller-Luftaustritt	1
6	36-35002-00050	Spannband m. Dichtung	1
7	36-40002-00020	Gebläserad 28 mm Bohrung	1
8	36-25002-00090	Schwenkhebel v. Luftdüse EB-909	1
9	36-35002-00010	Turbinengehäuse EB-909 /913	1
10	36-35002-00030	Flanschteil zw. Motor u. Turbine	1
11	36-40002-00015	Drehteil f. Turbinenaufnahme	1
12	12-GX-390SXQ-4	Honda-Motor 13 PS	1
13	12-06185ZF-6W-400	Nachrüstsatz Auspuffgitter	1
14	36-10002-00060	Flanschplatte für Motorbefestigung	1
15	36-10002-00020	Führungsholm	1
16	36-10002-00010	Rahmen	1
17	36-10002-00030	Scharnier kompl., Führungsh.	1
18	36-25002-00060	Gashebel	1
19	36-25002-00030	Griff für Handhebel	1
20	36-25002-00040	Handhebel für Bed. Luftdüse	1
21	36-25002-00020	Gestänge für Bed. Luftdüse	1
22	36-25002-00070	Gewindebolzen	1
23	36-15002-00020	Radkappen 38mm	2
24	36-00-0002-0	Lagerring EB - Rad	2
25	36-15002-00010	Rad kpl.: 4.00x10, 6 PR	2
26	36-00-0005-0	Rollenlager f. EB-900/901/909	2
27	36-10002-00040	Achse für Stützwalze EB-909/913	1
28	36-10002-00050	Stützwalze aus Kunststoff	1
29	36-90200-06050	Blechschaube 6x50	5
30	36-35002-00080	Kunststoffbuchse 21x6,5x31,5	2
31	36-35002-00090	Kunststoffbuchse 21x6,5x14	6
32	36-90100-05016	Schraube M5x16	5
33	36-80-0024-0	Deckscheibe Flansch EB-909-913	1
34	36-80-0025-0	Sechskantschraube M8x130	1
35	36-25002-00110	Spiralfeder, 11x1x62,4	1
36	36-25002-00100	Bowdenzug Bed. Luftdüse	2
37	36-90300-03060	Schwerspannsstift (DM3x60)	1
38	36-25002-00120	Klammer für Befestg. Bowdenz.	2
39	36-90200-05016	Blechschaube 5x16	6
40	36-90650-00005	Mutter M5, selbstsichernd	5
41	36-90700-00010	U-Scheibe U10	8
42	36-90700-40010	U-Scheibe M10, AD=40mm	4
43	36-90670-00010	Rändelmutter M10 zur Verstel.	1
44	36-90500-80000	Keil für Befestigung Turbine	1
45	12-90741-889-810	Keil 7x7x33 (Gelb)	1
46	36-90300-04020	Schwerspannsstift (DM4x20)	1
47	36-80-0019-0	Sechskantschraube 10x50mm	4
48	36-90700-00010	U-Scheibe U10	4
49	36-90650-00010	Mutter M10, selbstsichernd	7
50	36-10002-00080	Gummi-Met. Puffer - Holm EB	1
51	36-90100-08070	Schraube M8x70	1
52	36-80-0020-0	Scherspannstift EB-909/913	1
53	36-25002-00010	Gaszug	1
54	36-90120-12050	Rändelschraube, M12 x 37mm	1



EB-913



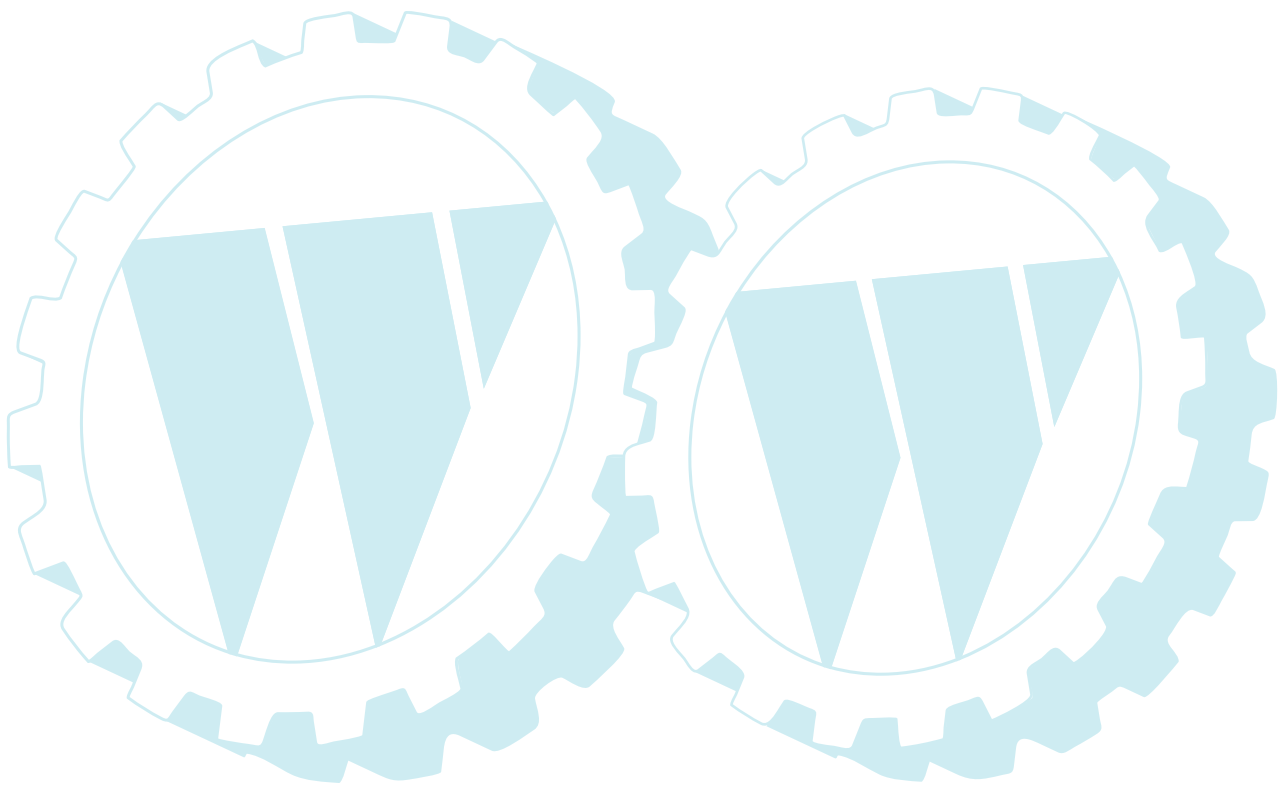



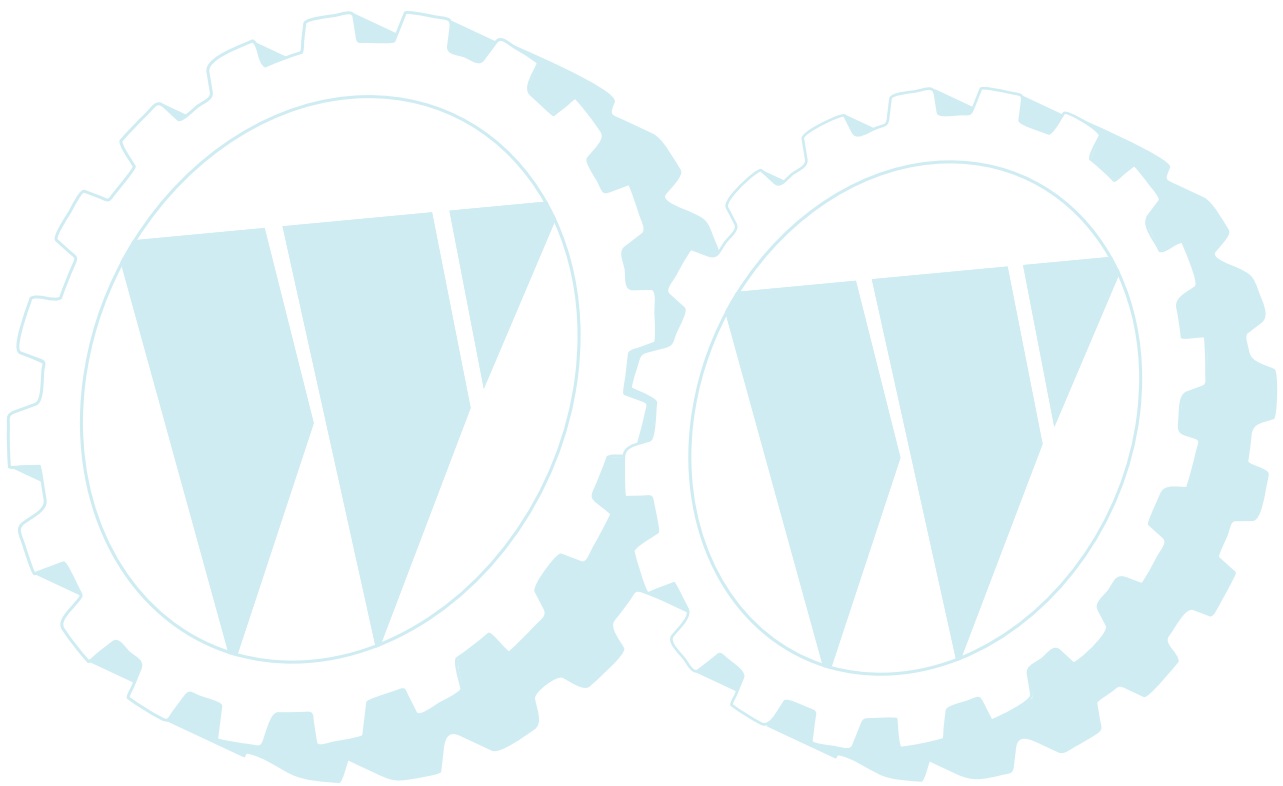



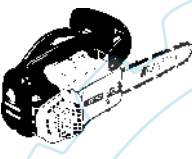

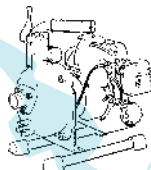
Bild	Artikelnummer	Bezeichnung	Menge
55	36-90300-03060	Schwerspannsstift (DM3x60)	2
56	36-80-0018-0	Splint 2,5 x 30	2
57	36-10002-00070	Gummi-Met.-Puffer	3
58	36-90700-00008	U-Scheibe U8	9
59	36-90650-00008	Mutter M8, selbstsichernd	14
60	36-90100-08016	Schraube M8x16	1
61	36-60002-00050	Aufkleber "Echo"	1
63	06-02-8196-00	Schraube 5/16"Unf x 1"Ht	6
64	36-90100-08070	Schraube M8x70	1
65	36-60002-00040	Aufkleber "EB-913"	1
66	36-60002-00050	Aufkleber "Echo"	1
67	36-25002-00050	Spiralfeder 16x2x30x3,5	1
68	36-90400-04012	Popniet 4x12	5



EB-913

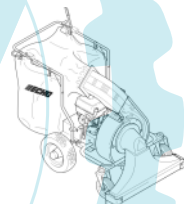

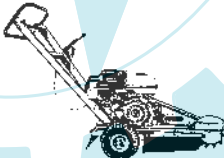
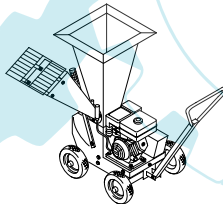
Wir bezeichnen uns als die besten Spezialisten für Pflagetechnik im Aussenbereich zwischen 1.000 m² und 20.000 m² mit einer hervorragenden Serviceorganisation.

 Motorsägen	 Trennschneider	 Wasserpumpen	 Rückenspritze	 Bohrgerät
 Hochentaster	 Motorsensen	 Heckenscheren	 Blasgeräte	 Laubsauger
 Großbläser	 Stumpenfräse	 Häckselwölfe	 Rasentraktoren	 Kehrmaschinen

Grundstückspflege ist unsere Stärke

überreicht durch: