

KREISELRASENMÄHER

GR389-----A

TYPE 1

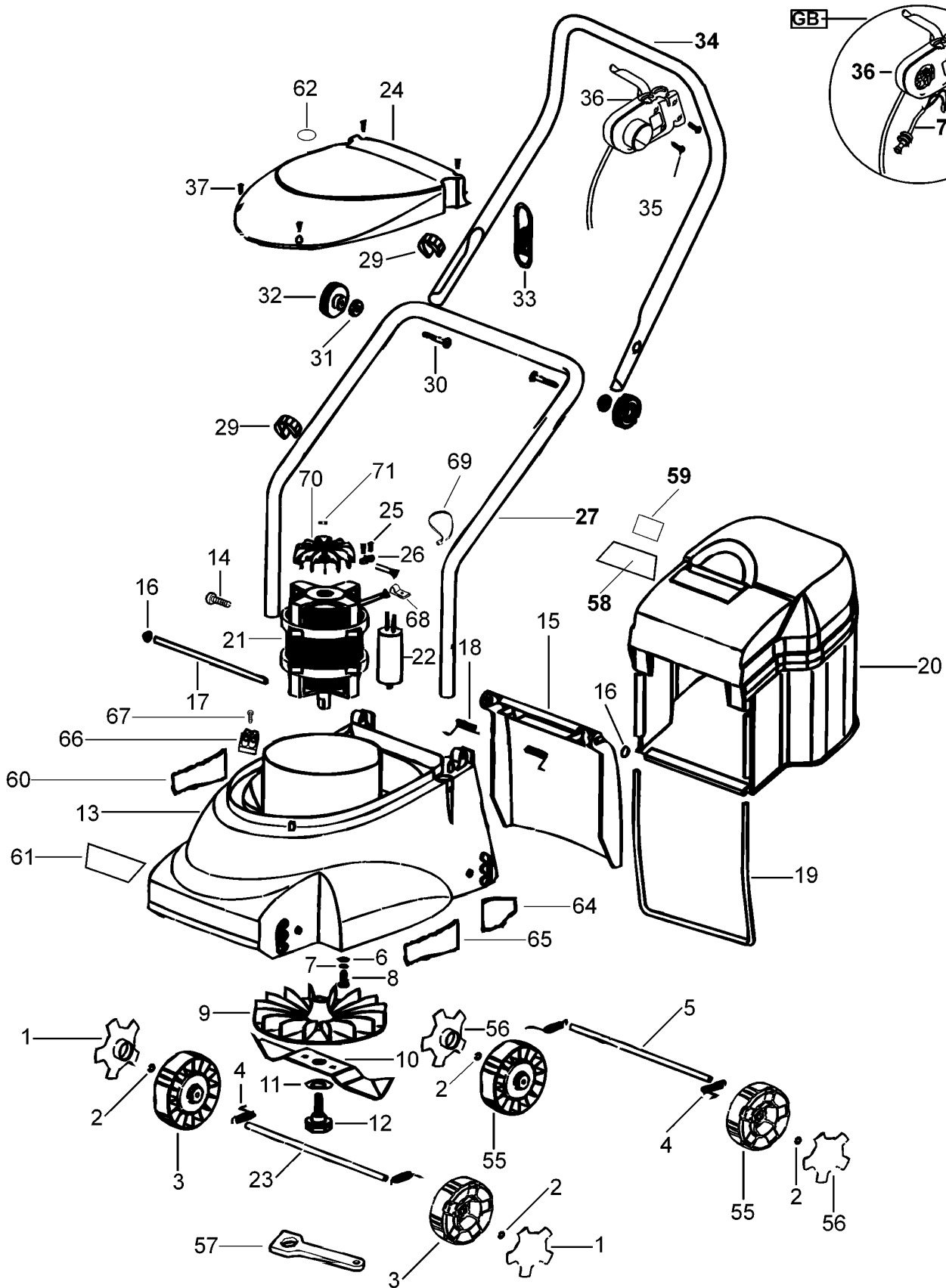

KREISELRASENMÄHER

GR389-----A

TYPE 1



Pos. Nr	Ersatzteilnummer	Beschreibung	Preis	Variants
1	2	569075-00	KAPPE	
2	4	568054-00	HALTER	
3	2	569077-00	RAD	
4	4	596740-00	FEDER	
5	1	596741-00	HINTERE ACHSE	
6	4	567798-00	UNTERLEGSCHEIBE	
7	4	568051-00	UNTERLEGSCHEIBE	
8	4	596742-00	BOLZEN	
9	1	1003230-00	LUEFTER	
10	1	596744-00	MESSER	
11	1	596745-00	UNTERLEGSCHEIBE	
12	1	596746-00	BOLZEN	
13	1	596747-00	FRASER BODEN	
14	2	568695-00	SCHRAUBE	
15	1	596748-00	GRASSFLAP	
16	2	596749-00	KLIP	
17	1	596750-00	STANGE	
18	1	596751-00	FEDER	
19	1	596752-00	RAHMEN	
20	1	596753-00	GRASFANGSACK ZSB	
21	1	596754-00	MOTOR	
22	1	596755-00	KONDENSATOR	
23	1	596756-00	VORDERE ACHSE	
24	1	596757-00	MOTORABDECKUNG	
25	3	596758-00	SCHRAUBE	
26	1	596759-00	KABELKLEMME	
27	1	596760-00	UNTERER GRIFF	
29	2	567788-00	KABELKLEMME	
30	2	567797-00	BOLZEN	
31	2	567789-00	UNTERLEGSCHEIBE	
32	2	279745-00	KNOPF 340050	
33	1	559799-00	HALTER	
34	1	596761-00	OBERER GRIFF	
35	2	596762-00	SCHRAUBE	
36	1	1002740-00	SCHALT.KASTEN ZSB	GB
36	1	597242-00	SCHALT.KASTEN ZSB	QS
37	4	596763-00	SCHRAUBE	
55	2	596279-00	RAD	
56	2	596280-00	KAPPE	
57	1	596764-00	SCHLUESSEL	
58	1	596765-00	SCHILD	
59	1	596766-00	AUFKLEBER	
60	1	596767-00	SCHILD	
61	1	596768-00	TYPENSCHILD	
62	1	596769-00	AUTO-STOP-SCHILD	
64	1	596772-00	SCHILD	
65	1	596773-00	SCHILD	
66	1	596802-00	ANSCHLUSSBLOCK	
67	1	596803-00	SCHRAUBE	
68	1	596804-00	BEFESTIGUNGSHALTER	
69	2	596805-00	KABEL TIE	
70	1	596806-00	LÜFTER	
71	1	596807-00	FESTSTELLRING	
72	1	799370-09	KABEL M/PLUG 16M	GB