

ROPER REAR TINE TILLER--MODEL NUMBERS RT150DR & RT150CT

MAIN FRAME

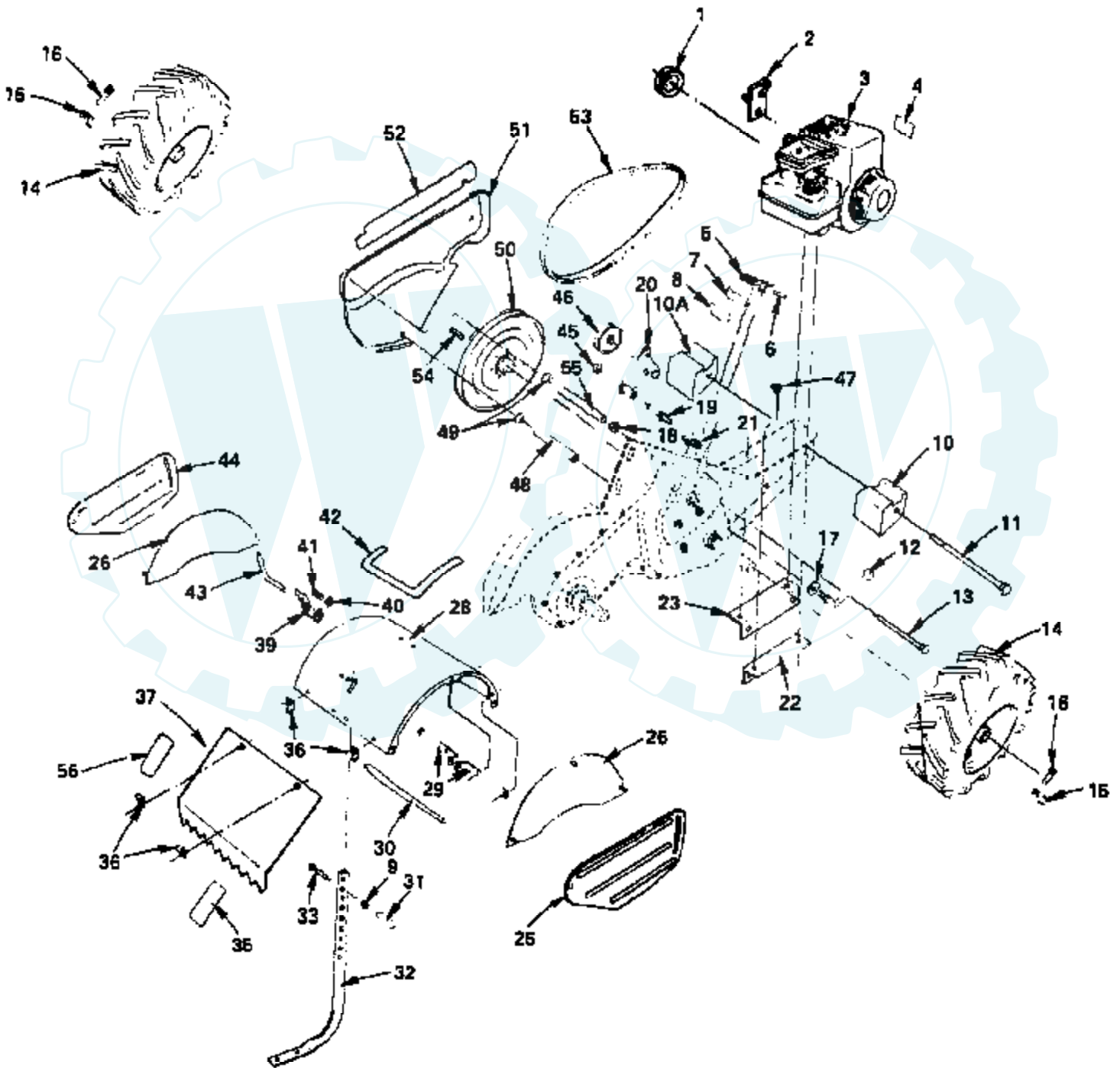

Ref #	Part Number	Qty	Description
1	102142X		SUB= 130816
2	102376X		BRACKET ASSY CRT
3	130202		NLA
4	102697X		DECAL - 5HP
5	102166X		SUB= 110111X
6	1572H		SUB= 2882J
7	8700J		PANEL TI
8	102180X		DECAL CRT
8	104323X		NLA
9	73220600		NUT.HEX.3/8-16UNC
10	102173X		COUNTERWEIGHT CRT
10A	102383X		COUNTERWEIGHT CRT
11	102384X		BOLT CRT
12	102373X		SUB= 109228X
13	74930576		BOLT-HEX TI
14	102189X		SUB= 124258X
	102190X		TIRE.CHV.13X5.0-6
	795R		SUB= 65139
15	4497H		RETAINER M
16	102841X		SUB= 126875X
17	19131414		WASHER
18	73220500		NUT.HEX.5/16-18
19	102141X		SHIFT ARM CRT
20	105611X		SUB= 918105611X
21	9484R		CONDIUT CLIP T
22	102332X		BRACKET RH CRT
23	102331X		BRACKET LH CRT
25	104101X358		NLA
26	104085X358		SUB= 104085X505
28	102326X358		NLA
29	102155X		SUB= 124343X
30	102154X		SUB= 120588X
31	102701X		GRIP CRT
32	102156X		SUB= 102156X500
33	74930632		BOLT
35	104476X		NLA
35	104816X		NLA
36	4440J		HINGE CRT
37	102695X358		SHLD-LEVELING TI
39	8392J		LATCH BRACKET TI
40	12000036		KLIP RING TI
41	8394J		SPRING TI
42	102698X		DECAL - TINE SHIELD
43	8393J		STAKE PIN TI
44	104086X358		SUB= 104086X505
45	12000032		KLIP RING
46	104679X		PULLEY-IDLER TI
47	105897X		GROMMET TI
48	104370X		SPACER CRT
49	19111116		WASHER
50	100473M		"SHEAVE 10"" CRT"
51	102148X358		SUB= 131159X428
52	102699X		NLA
53	102143X		SUB= 132672
54	2649M		KEY T
55	104369X		SPACER CRT
56	104949X		DECAL - DEPTH ADJUSTMENT

ROPER REAR TINE TILLER--MODEL NUMBERS RT150DR & RT150CT

MAIN FRAME

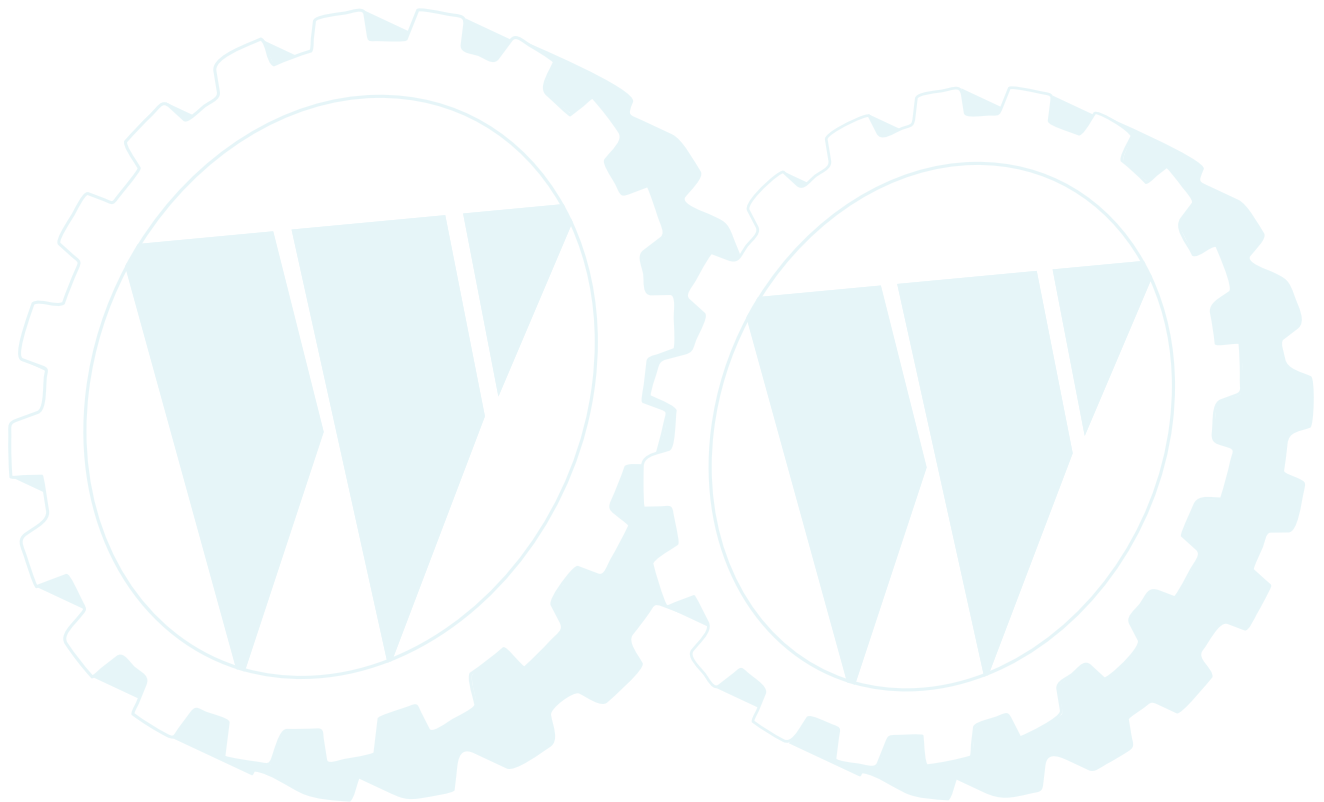
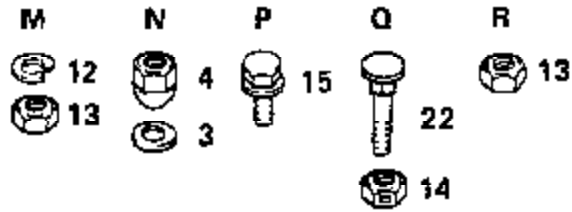

Ref #	Part Number	Qty	Description
3	19111116		WASHER
4	104214X		NUT TI
12	10040600		LOCKWASHER
13	73220600		NUT.HEX.3/8-16UNC
14	5394H		SUB= 73930600
15	17561008		SCREW TI
22	72140608		SUB= 72110608

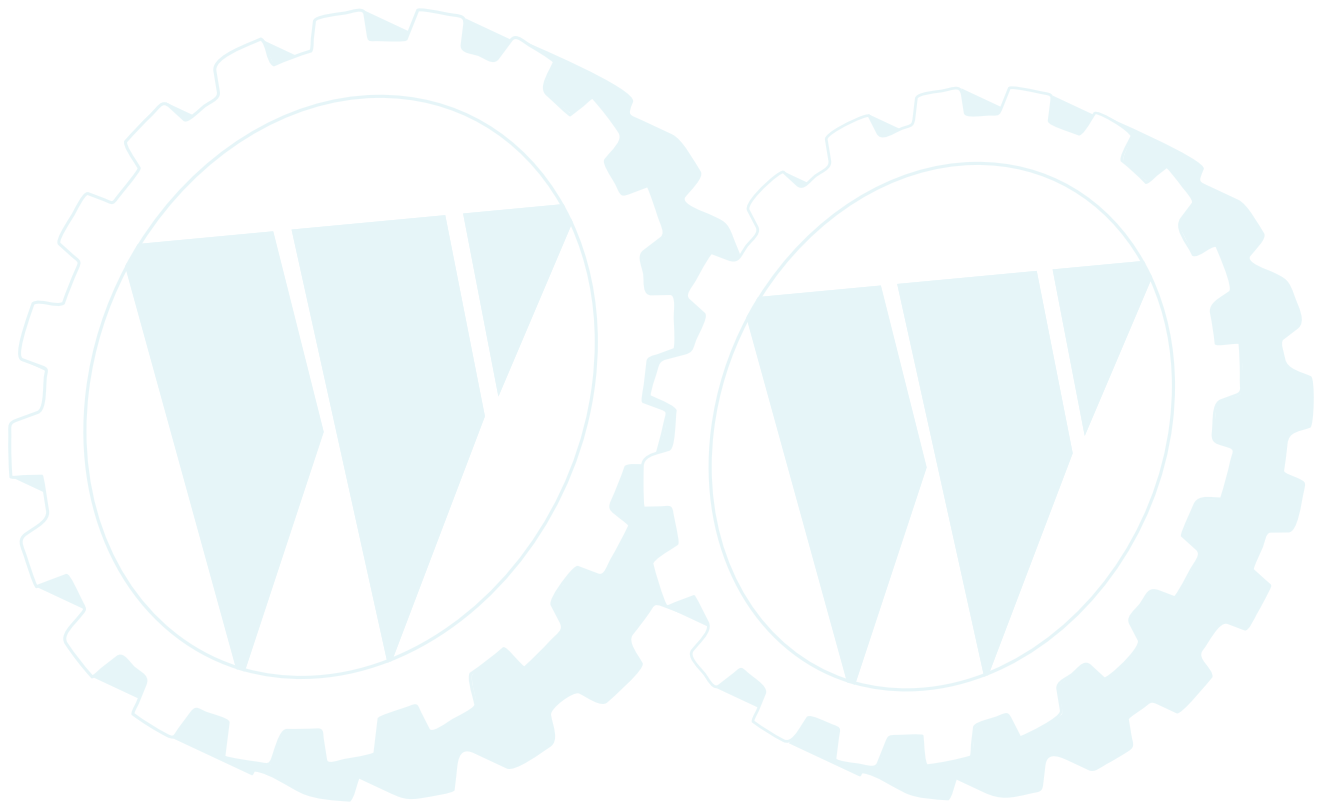

ROPER REAR TINE TILLER--MODEL NUMBERS RT150DR & RT150CT

MAIN FRAME

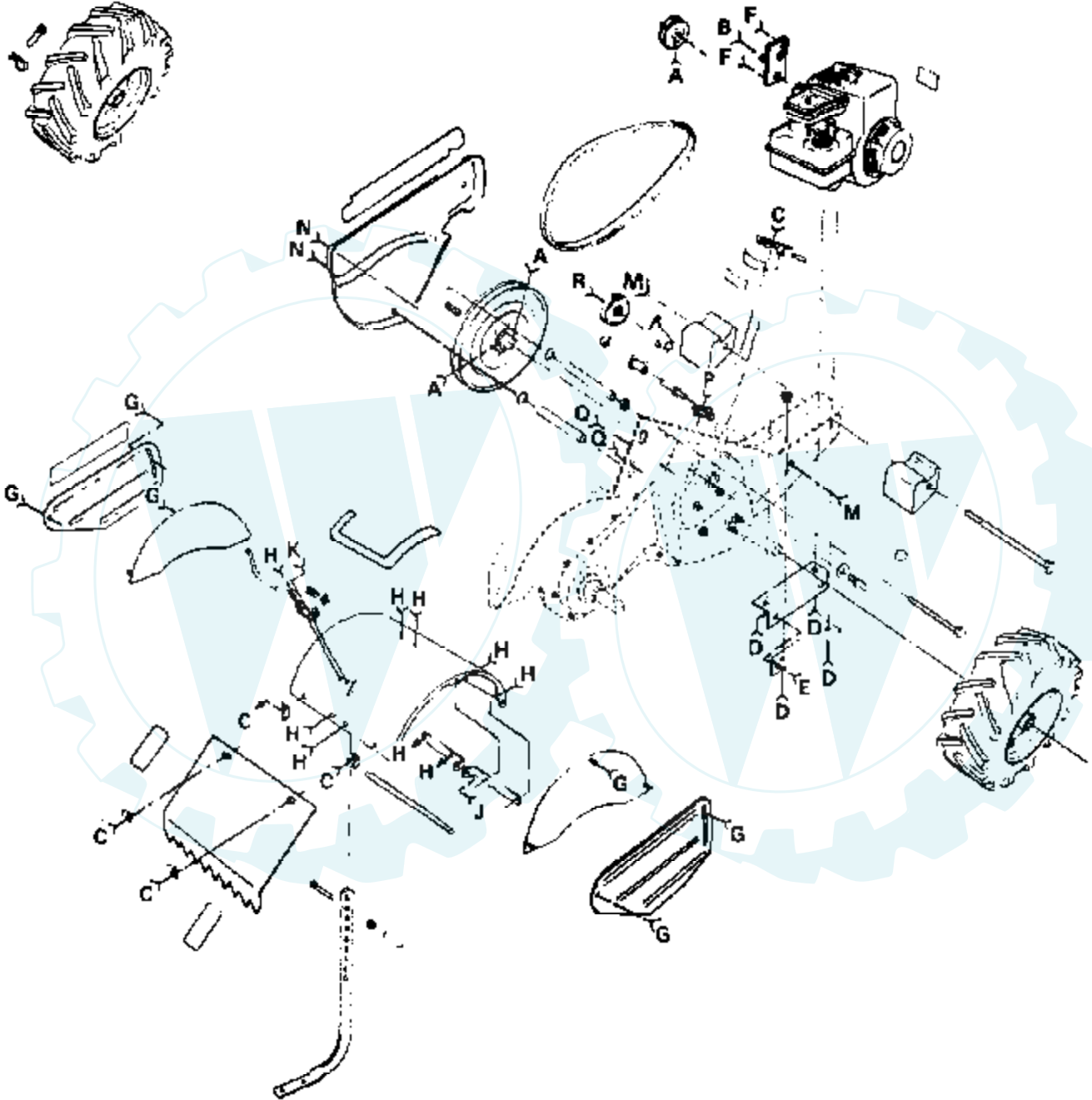

- | | | | | | | | | | |
|----------|----------|-------------|--------------|----------------|---------------|----------|---------------|---------------|---------------|
| A | B | C | D | E | F | G | H | J | K |
| 1 | 3
4 | 5
6
7 | 8
9
10 | 11
12
13 | 14
15
7 | 16 | 17
9
10 | 18
9
10 | 19
9
10 |

Ref #	Part Number	Qty	Description
1	23230506		SET SCREW
3	19111116		WASHER
4	104214X		NUT TI
5	72140404		BOLT
6	10040400		LOCKWASHER
7	73220400		SUB= 50675
8	74760524		BOLT.HEX.5/16-1.5
9	10040500		LOCKWASHER
10	73220500		NUT.HEX.5/16-18
11	74760616		BOLT
12	10040600		LOCKWASHER
13	73220600		NUT.HEX.3/8-16UNC
16	98000129		NUT
17	72140505		BOLT
18	72110508		BOLT CRT
19	72140506		BOLT

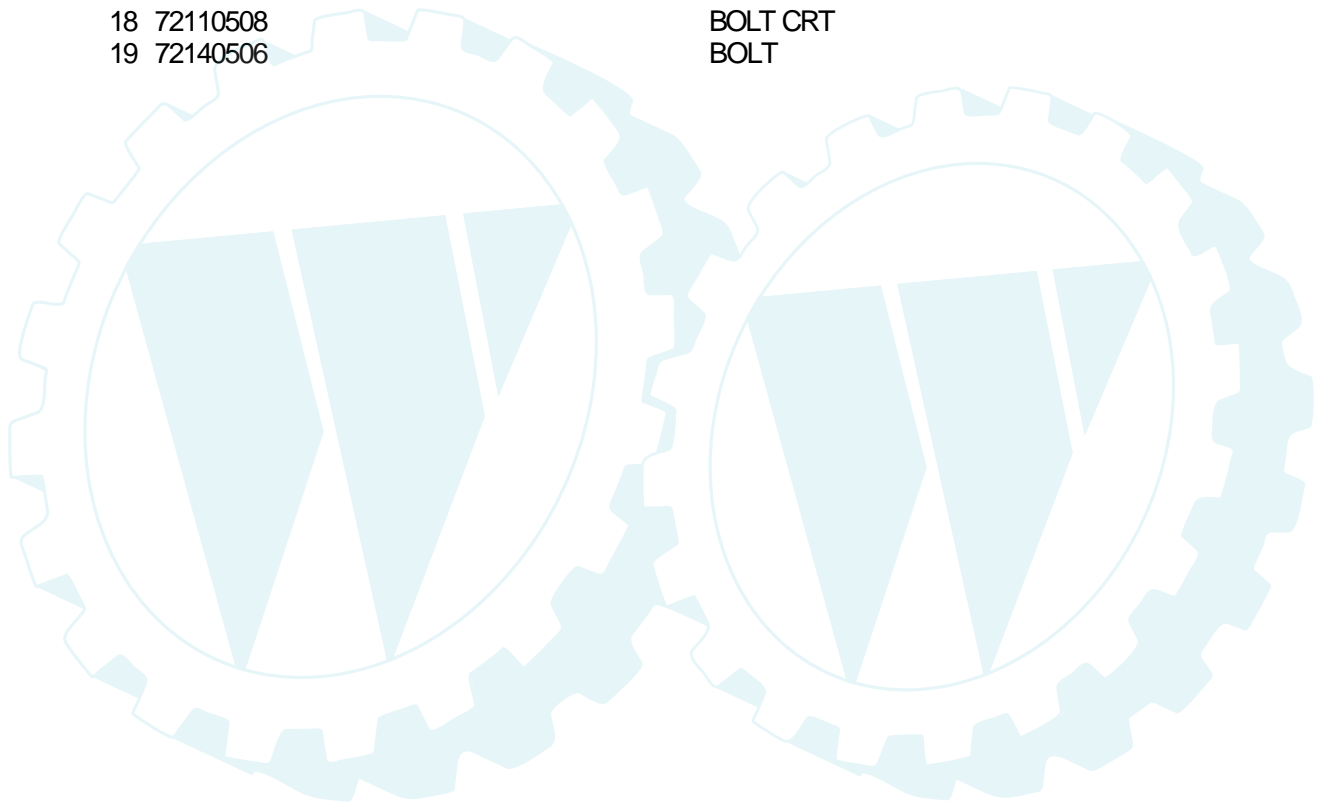

ROPER REAR TINE TILLER--MODEL NUMBERS RT160DR & RT150CT

TINE ASSEMBLY

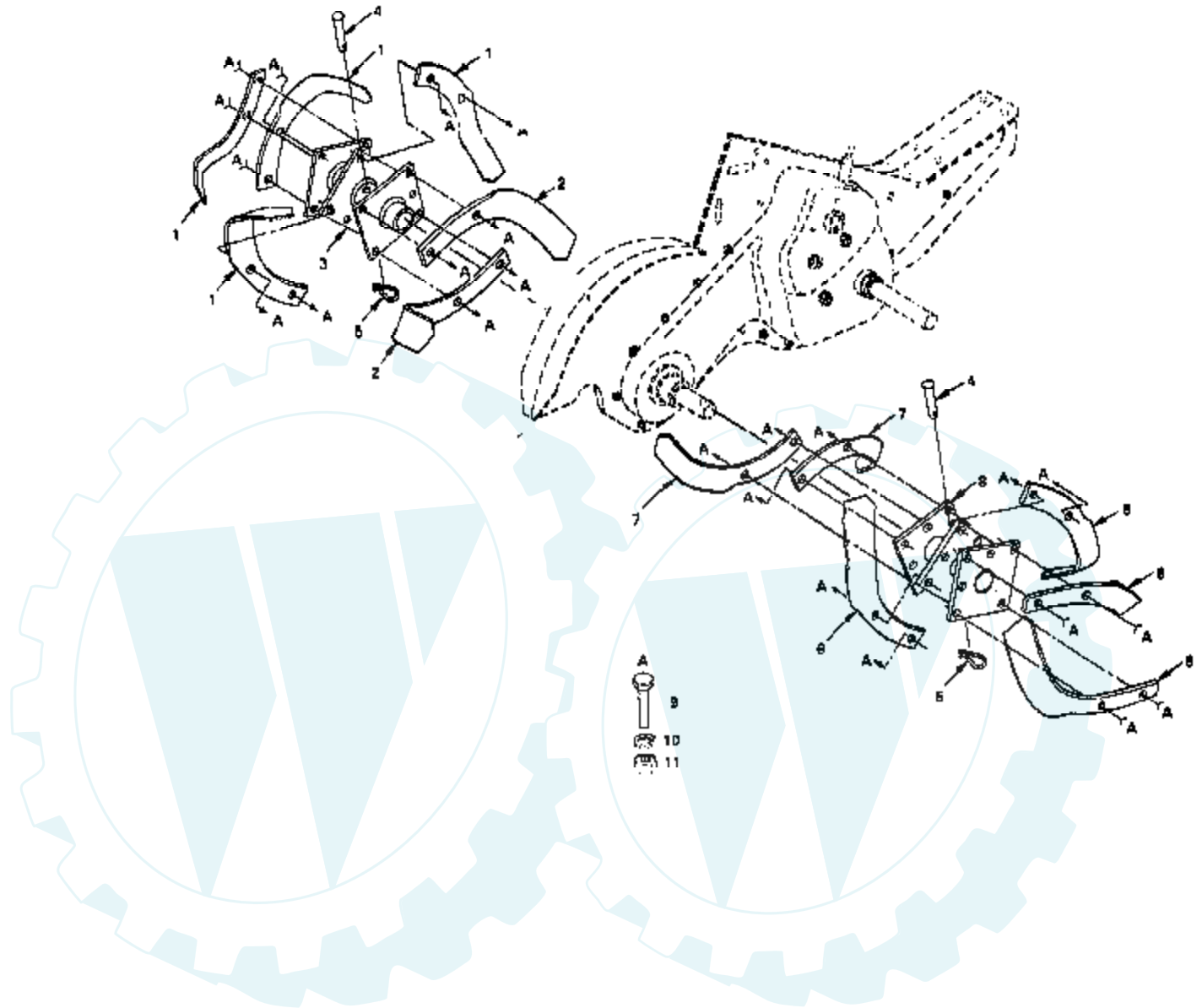

Ref #	Part Number	Qty	Description
1	4459J		SUB= 6554J
2	6554J		"TINE.LH.12""
3	102380X		TINE ASSY LH CRT
4	4929H		RIVET.PAN HD.1.75
5	3146R		RETAINER.SPRING
6	4460J		SUB= 6555J
7	6555J		"TINE.RH.12""
8	102382X		TINE ASSY RH CRT
9	74610616		BOLT
10	10040600		LOCKWASHER
11	73610600		SUB= 7810H
	108150X		NLA

