

20 HP 50" TRACTOR - - MODEL NUMBER TS2051A

50" MOWER

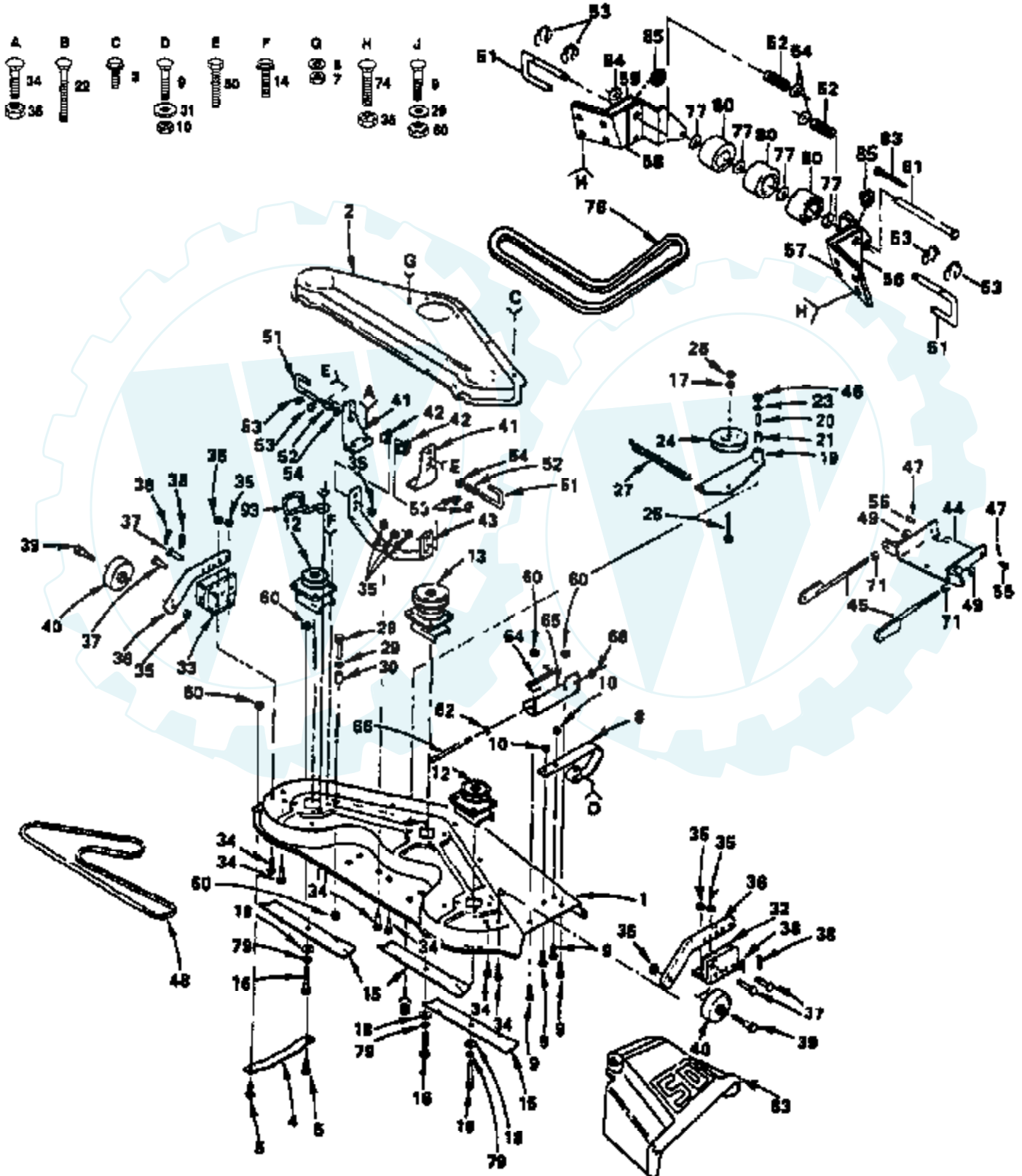

Ref #	Part Number	Qty	Description
1	121664X		SUB= 123760X
2	121811X		CVR DRIVE DECK
3	17490508		SCREW LT
4	7631J		RUNNER-LH M
5	72110505		BOLT
6	10040500		LOCKWASHER
7	73220500		NUT.HEX.5/16-18
8	120449X		SUB= 136320
9	72140506		BOLT
10	1685H		SUB= 68478
12	136818		SUB= 136819
13	121617X		SUB= 121657X
14	17490612		SCREW
15	121798X		"BLADE.50""STD.LIFT"
16	74610624		BOLT.3/8-24X1-1/2
17	10040600		LOCKWASHER
18	19132012		WASHER
19	674A213		ARM ASSY GT
20	7834J		SUB= 674A308
21	7835J		SUB= 674A308
22	72110522		BOLT
23	19111816		SUB= 52915
24	102403X		IDLER-FLAT T
25	74760624		SUB= 74930624
26	73220600		NUT.HEX.3/8-16UNC
27	104361X		SPRING T
28	74780520		BOLT
29	19111216		WASHER M
30	8438J		SPACER SPLIT LT
31	19111116		WASHER
32	105448X		GUAGE WHL BRKT GT
33	105449X		GUAGE WHL BRKT GT
34	72240606		BOLT
35	73680600		SUB= 73690600
34	105453X		GUAGE WHL BAR GT
37	5565J		SUB= 139031
38	4939M		SUB= 85902
39	137644		BOLT.SHOULDER
40	133957		WHEEL GAGE DONUT
41	105433X		SUSP BRKT GT
42	110237X		SPACER GT
43	105434X		SUSP BRACE GT
44	109778X		SUB= 140741X431
45	109771X		BRACKET.SUSPEN.AS
46	73350500		JAM NUT TI
47	3146R		RETAINER.SPRING
48	3703J		V-BELT M
49	73680800		NUT LTV
50	74760622		BOLT
51	105435X		RELEASE PIN GT
52	3720R		SPRING M
53	12000039		KLIP RING
54	19171612		WASHER GT
55	105440X		CLEVIS PIN GT
56	105458X		BRACKET T
57	109773X		BRACKET T
58	110997X		BRACKET T
59	120000X		BRACKET T

Ref #	Part Number	Qty	Description
60	73680500		SUB= 73690500
61	109776X		PIVOT PIN T
62	19111016		WASHER
63	110509X		DEFLECTOR
64	106734X		SUB= 123713X
65	137607		BRKT DEFLECTOR
66	106735X		ROD-HINGE T
68	110452X		NUT PUSH M
71	73220800		NUT
74	72240608		BOLT
76	110884X		BELT-V.93.5.MWR
77	19151610		WASHER T
79	10030600		SUB= 10040600
80	109729X		ROLLER T
83	76020412		COTTER PIN
84	19151616		SUB= 19171616
85	120135X		SPACER T
93	121352X		BELT RETIANER
	127594X		SUB= 138513

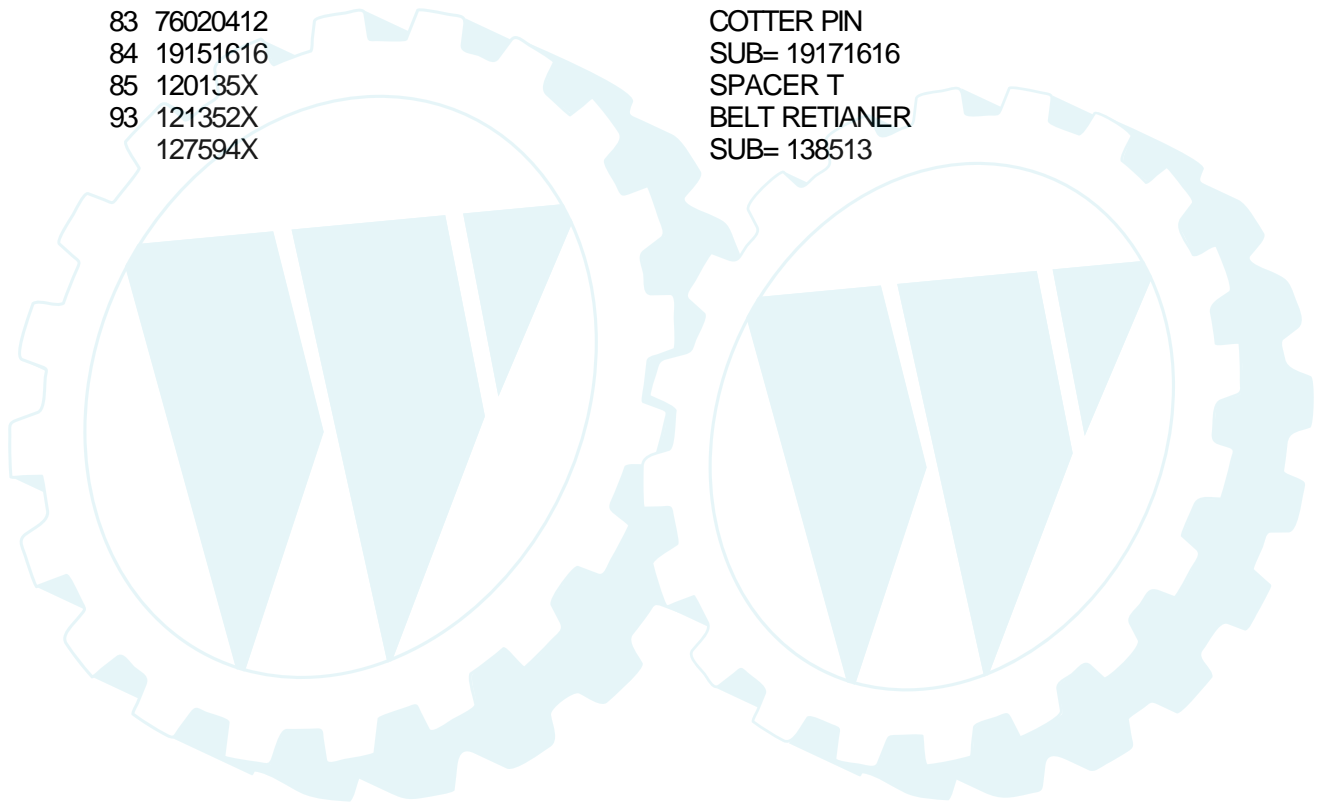

20 HP 50" TRACTOR - - MODEL NUMBER TS2051A

SCHEMATIC

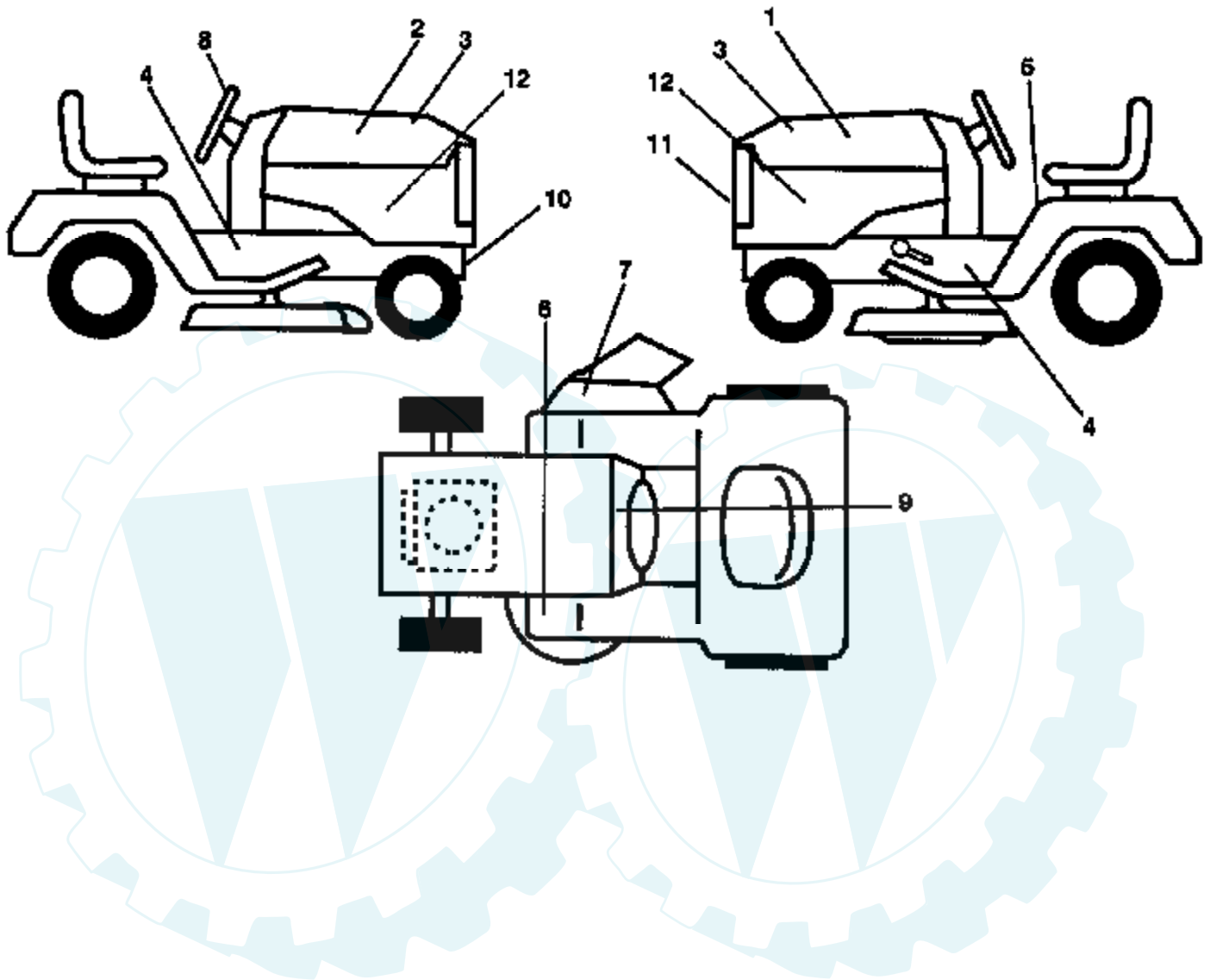

Ref #	Part Number	Qty	Description
1	139099		NLA
2	139098		NLA
3	135437		NLA
4	135436		NLA
5	133796		DECAL
6	4900J		DECAL T
7	121343X		DECAL WARING
8	135971		DECAL.STRG.WHL
9	136794		SUB= 138955
10	108367X		DECAL T
11	135438		PLATE.NAME.SMALL
12	138448		DECAL.PANEL.SIDE
	138753		MANUAL.O.TS2051A



20 HP 50" TRACTOR -- MODEL NUMBER TS2051A

ELECTRICAL

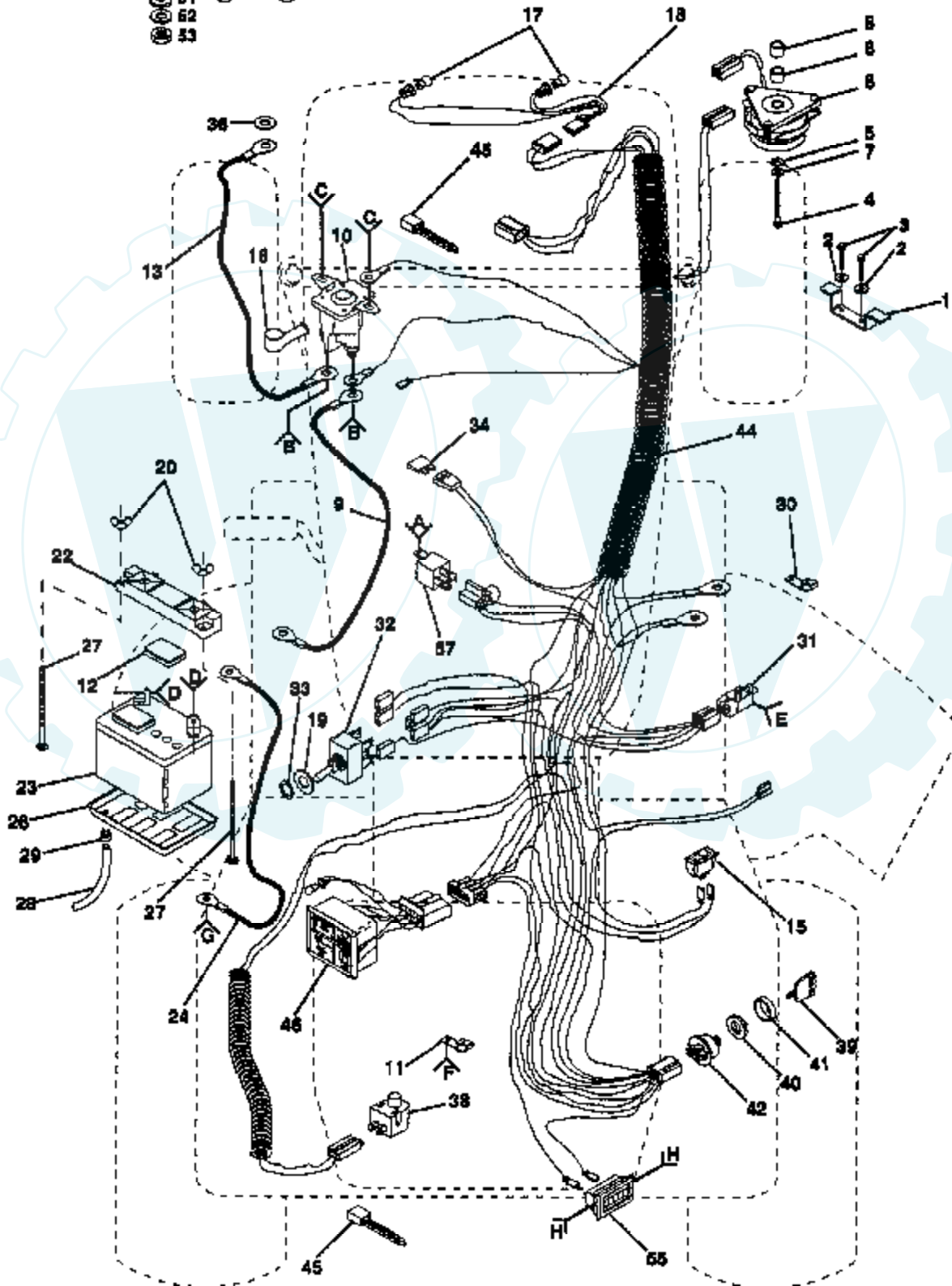
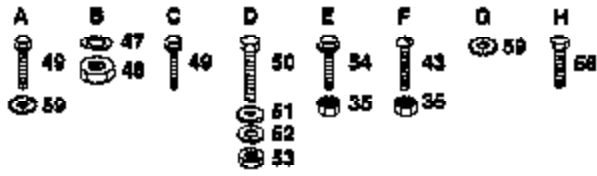

Ref #	Part Number	Qty	Description
1	110882X		STOP T
2	10040600		LOCKWASHER
3	74780612		BOLT
4	71130724		SUB= 871130724
5	126197X		WASHER
6	127170X		SUB= 133501
7	10040700		LOCKWASHER
8	128224		SPACER-CLUTCH
9	4799J		"CABLE T, BATTERY"
10	138406		SUB= 146154
11	4171R		CLIP T
12	121264X		"CAP,BATTERY "
13	129458		"CABLE,STARTER T"
15	110712X		SWITCH LT
16	131563		SUB= 154336
17	4152J		HEADLAMP BULB
18	136850		"HARNESS,LIGHT SOC"
19	19171216		WASHER
20	123198X		SUB= 146525
22	102476X		SUB= 150109
23	121537X		SUB= 123899X
24	121080X		SUB= 120606X
26	7603J		"TRAY T, BATTERY"
27	72240460		BOLT
28	7697J		"DRAIN TU T, BATT"
29	109596X		HOSE CLAMP T
30	100207K		CLIP GTV
31	109553X		SWITCH INTERLOCKT
32	126018X		SUB= 532126018
33	4022J		HEX NUT T
34	108824X		FUSE HYT
35	73951000		"NUT,KEPS"
36	11150400		LOCKWASHER
38	121305X		SWITCH SEAT
39	122147X		KEY
40	124211X		NUT IGNITION
41	123620X		SUB= 141226
42	4406R		SUB= STD365402
43	74641008		SUB= 71031008
44	139012		HARNESS.IGN
45	7192J		WIRE TIE
46	138101		LIGHT.PKG.ASM.
47	10090400		SUB= 10040400
48	73350400		NUT
49	17720408		SCREW
50	74760412		BOLT LT
51	19091016		WASHER
52	10040400		LOCKWASHER
53	73220400		SUB= 50675
54	71031008		SCREW
55	110940X		HOUR METER T
56	17011008		SCREW
57	109748X		RELAY ASSY T
59	11050600		LOCKWASHER

Ref #	Part Number	Qty	Description
1	109458X		FOAM STRIP T
2	128146		SUB= 532128146
3	132638X505		SUB= 150302X505
4	106088X		FOAM STRIP T
5	124238X		CAP SPRING
6	106784X		SUB= 155013
7	104618X		SUB= 155013
8	124392X417		SUB= 147717
9	106395X		LENS LT
10	122100X		GRILL ASSY
11	105419X505		GRILL STRAP
12	110854X		SUPPORT RH YTH
13	110855X		SUPPORT LH YTH
14	135258		BUMPER ASSY.
15	109808X		HOOD LATCH T
16	132639X505		"PANEL,SIDE RH "
17	137563		SUB= 140229
18	132635X505		SUB= 150301X505
19	124252X		SUB= 140398
20	8022J		PLUG-DASH T
21	123952X018		PLATE.DASH
22	131451		SUB= 155925
23	129598		SUB= 140121
24	74780816		BOLT
25	73680600		SUB= 73690600
26	133671		FOOTREST PAD
27	105465X505		SUB= 145244X505
29	110893X		SUB= 151630
30	109227X		PAD IDLER TI
33	2751R		CLIP T
35	124181X		SPRING COMPRESSIO
36	19111116		WASHER
37	105531X		NUT-PUSH YT
38	105509X		SUB= 137113
39	123549X		SUB= 158990
40	127334X		SUB= 151346
41	106082X		PAD-SPACER LT
42	105511X		SUB= 140675
43	121642X505		FENDER
45	126656X		SUB= 140551
46	106042X018		SADDLE.6SP.GT
47	73510500		NUT
48	104608X		DASH ASSEMBLY
49	3645J		BUSHING OUTLET T
50	139227		SUB= 139277
51	123487X		HOSE CLAMP
52	7834R		SUB= 8542R
53	7982J		SUB= 140506
54	138597		SUB= 150383
55	105464X505		SUB= 145243X505
57	17490612		SCREW
58	74760612		SUB= 74780612
59	73680600		SUB= 73690600
60	19091216		WASHER PM
61	73220400		SUB= 50675
63	74760616		BOLT
65	74180512		SCREW
66	73680500		SUB= 73690500

Ref #	Part Number	Qty	Description
67	17720408		SCREW
68	72140506		BOLT
69	74191008		SCREW
70	10071000		LOCKWASHER
71	2029J		WELDNUT
72	17211010		SCREW LT
73	104755X		""J"" FASTENER LT"
74	123481X		SUB= 7605J
75	73680400		SUB= 73690400
76	17490412		SCREW HEX CRT
77	17490512		SCREW
78	19091016		WASHER
79	74981020		SCREW
80	7206J		SPACER LT
81	19070818		WASHER
82	73731000		NUT
83	74760716		BOLT
84	73680700		NUT GTV
85	17490608		SCREW LT
88	105529X		SUB= 139888
91	105500X		BELT RETAINER GT
92	19131312		WASHER
95	4171R		CLIP T
97	120068X		"KNOB 1/2"" YT"
99	127018X		"BOLT,SHOULDER"
101	110853X		SUPPORT RH YTH
102	110852X		SUPPORT LH YTH
104	123198X		SUB= 146525
106	19131614		WASHER
107	72050411		SUB= 872050411
108	121251X		STRIP FORM
109	123740X		SPRING COMPRESSED
110	121249X		SPACER SPLIT
111	121246X		BRKT SWITCH
112	121248X		BUSHING
113	123976X		SUB= 73900400
114	73510400		NUT
115	19171912		WASHER
116	17490616		SCREW GTV
117	19091016		WASHER
118	127637		"SHIELD,HEAT"

20 HP 50" TRACTOR - - MODEL NUMBER TS2051A

GROUND DRIVE

- B 105
- C 96
- D 98
- E 100
- F 103
- H 101
- J 102
- K 103
- L 105
- M 4
- N 101
- P 125
- Q 45
- R 114
- T 118
- 97
- 131
- 45
- 45
- 111
- 94
- 104
- 98
- 45
- 45
- 110
- 111
- 45
- 115

- U 117
- V 119
- W 119
- X 124
- Y 121
- Z 109
- AA 123
- 97
- 120
- 118
- 94
- 17
- 122

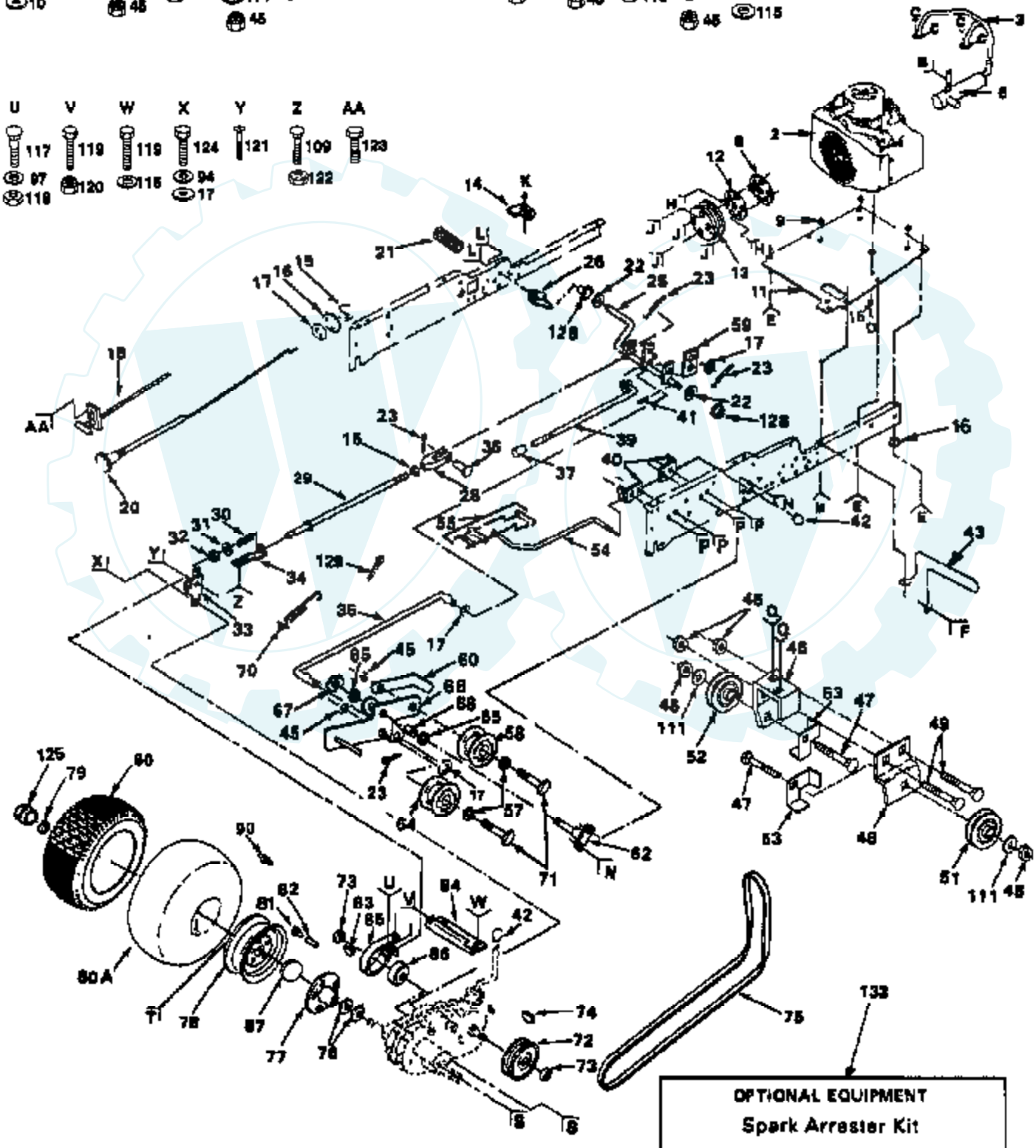

Ref #	Part Number	Qty	Description
2	PS-49603		ENG., KOHLER, M20
3	110891X		EXHAUST TUBE T
4	74780624		"BOLT,HEX"
6	127881		MUFFLER EXHAUST
8	110947X		CHAFF GUARD T
9	133692		SPACER.ENGINE KOH
10	19091212		WASHER
11	110867X		"ENG. T, BASE"
12	104577X		ADAPTER T
13	121355X		SUB= 101343L
14	5304J		ACT-SWITCH T
15	73610600		SUB= 7810H
16	11050600		LOCKWASHER
17	19131316		WASHER
18	132746		SUB= 532132746
20	132780		SUB= 532132780
21	8883R		PEDAL COVER T
22	121749X		WASHER
23	76020312		SUB= 3145
25	104375X		SHAFT ASSY GT
26	104601X		BRKT SWITCH GT
28	100604K		YOKE GTV
29	5308J		BRAKE ROD T
30	7241J		SPRING T
31	19131614		WASHER
32	73530600		SUB= 7810H
33	677A637		BRAKE BRKT ASSY T
34	7229J		GUIDE ROD T
35	101356L		ROD CLUTCH GTV
36	5102J		CLEVIS PIN T
37	71673		PLUNGER CAP T
39	136284		BRAKE ROD
40	105598X		ROD BRACKET GT
41	5142H		ROLL PIN STD
42	121466X		KNOB
43	108885X		GUARD MUFFLER HYT
45	73680600		SUB= 73690600
46	121063X		SUB= 139995
47	72110614		BOLT
48	122825X		BRKT IDLER FLAT
49	72140606		BOLT
51	102403X		IDLER-FLAT T
52	101344L		PULLEY V IDLR GTV
53	122824X		GUARD BELT
54	122253X		ROD SHIFT HI LO
55	122268X		CONNECTING LINK
57	19131413		WASHER
58	104360X		SUB= 131494
59	121358X		RETAINER SPRING
60	121360X		RETAINER BELT
62	101358K		BRACKET ASSY GTV
64	121361X		SUB= 139123
65	207J		WASHER T
66	121356X		BRACKET CLUTCH
67	12000039		KLIP RING
68	105706X		"LY, BEARING"
70	121357X		SPRING EXT CLUTCH
71	74760628		BOLT

Ref #	Part Number	Qty	Description
72	137524		SUB= 532137524
73	9204H		NUT STD
74	9858M1		KEY
75	110883X		BELT-V.98.5.GD.DV
76	7563R		WASHER T
77	135758X431		SUB= 149176X431
78	106277X361		SUB= 106277X417
79	12000034		KLIP RING
80	105588X		SUB= 122077X
80A	7154J		TUBE.23X8/10-12
81	59192		VALVE CAP
82	65139		VALVE STEM LT
83	2228M		SUB= 2228M1
84	120404X		SUB= 156404
85	101122M		BRAKE BAND ASM
86	214J		BRAKE DRUM T
87	136327		"COVER, HUB"
89	73680400		SUB= 73690400
90	6856M		ZERK FITTING M
94	10040600		LOCKWASHER
96	74570512		SCREW
97	10040400		LOCKWASHER
98	74760620		SUB= 74780620
100	74760612		SUB= 74780612
101	74780616		BOLT
102	17190516		SCREW
103	74321016		SCREW
104	73631000		SUB= 69180
105	74760412		BOLT LT
108	72140610		BOLT.3/8-14X1.25
109	72110506		SUB= 72270506
110	73680500		SUB= 73690500
111	19131612		WASHER GT
114	74760720		BOLT
115	10040700		LOCKWASHER
116	1304H		SUB= 140080
117	72140405		BOLT T
118	73220400		SUB= 50675
119	74760716		BOLT
120	73680700		NUT GTV
121	74370612		SCREW
122	1685H		SUB= 68478
123	17720410		SCREW LT
124	74760614		SUB= 74760616
125	104758X		CAP-HUB GT
126	72140506		BOLT
128	110895X		NYLINER T
129	76020816		COTTER PIN
131	10170500		LOCKWASHER
133	132922		SPARK ARREST KIT

20 HP 60" TRACTOR -- MODEL NUMBER TS2051A

LIFT ASSEMBLY

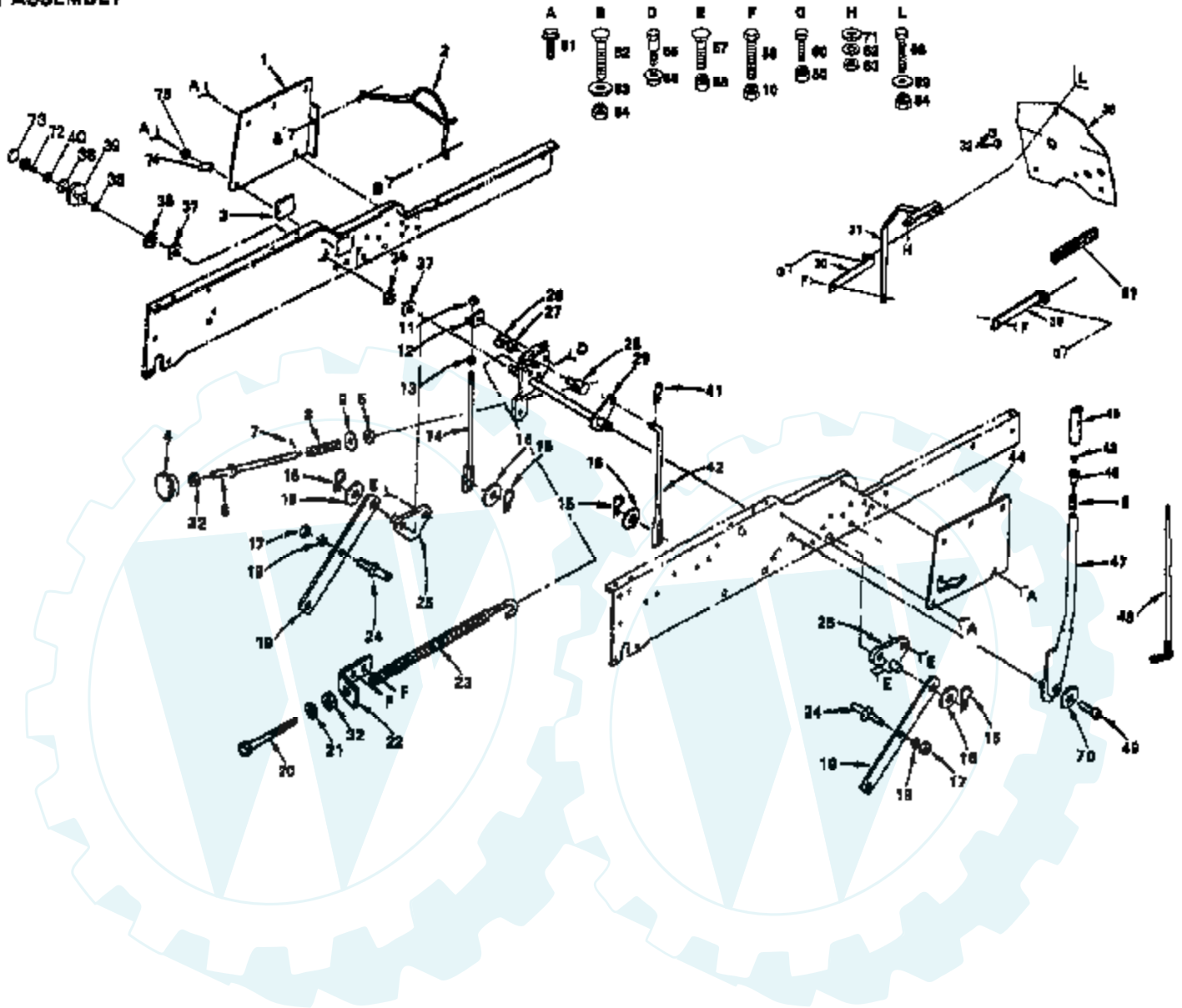

Ref #	Part Number	Qty	Description
1	121046X		SUB= 532121046
2	126651X		"GUARD, BELT"
3	121794X		COVER ACCESS
4	138057		KNOB INF 3/8-16
5	110807X		NUT T
6	110811X		ROD ADJ. T
7	76020308		SUB= 3145
8	2876H		SPRING T
9	19131016		WASHER
10	73680600		SUB= 73690600
11	73800600		NUT
12	7594J		BRACKET T
13	73220600		NUT.HEX.3/8-16UNC
14	7596J		LINK-LIFT MOW T
15	9135R		SPRING H
16	19171616		WASHER
17	73220800		NUT
18	10040800		LOCKWASHER
19	105429X		SUSPENSION ARM GT
20	5328J		BOLT-ADJ SPRING T
21	19131316		WASHER
22	5329J		SUB= 143363
23	674A247		SUB= 918674A247
24	105413X		PIVOT STUD GT
25	105501X		SUSP BRACKET T
26	12000037		KLIP RING
27	19151216		WASHER
28	110810X		TRUNION LT
29	124217X		SHAFT ASS'Y LIFT
30	110903X		BRACKET T
31	128141		SUB= 532128141
32	73350600		NUT
33	110436X		SUB= 9151R
34	122085X		"SHIELD HEAT, BASE"
35	12000022		E-RING
36	19292016		WASHER
37	19112410		WASHER
38	123934X		HEIGHT INDICATOR
39	10040500		LOCKWASHER
40	4939M		SUB= 85902
41	105503X		LIFT LINK RH T
42	124526X		SUB= 125925X
43	121045X		SUB= 532121045
44	109413X		GRIP
45	122364X		SUB= 125925X
46	121002X363		SUB= 123096X
47	121006X		LEVER ROD LT
48	74780624		"BOLT,HEX"
49	73680400		SUB= 73690400
50	17490608		SCREW LT
51	72140508		BOLT
52	19111610		WASHER
53	73680500		SUB= 73690500
54	7901J		SHOULDER BOLT T
55	73900400		NUT T
56	72140606		BOLT
57	73930600		LOCKNUT
58	74760616		BOLT

Ref #	Part Number	Qty	Description
60	74780408		BOLT
61	109458X		FOAM STRIP T
62	10090400		SUB= 10040400
63	73220400		SUB= 50675
68	74760512		BOLT
69	19111216		WASHER M
70	10040600		LOCKWASHER
71	19091216		WASHER PM
72	74780516		SUB= 77394
73	123935X		"PLUG,HOLE"
74	123933X505		POINTER HGT IND
75	120529X		WASHER T



20 HP 50' TRACTOR - - MODEL NUMBER TS2051A

SCHEMATIC

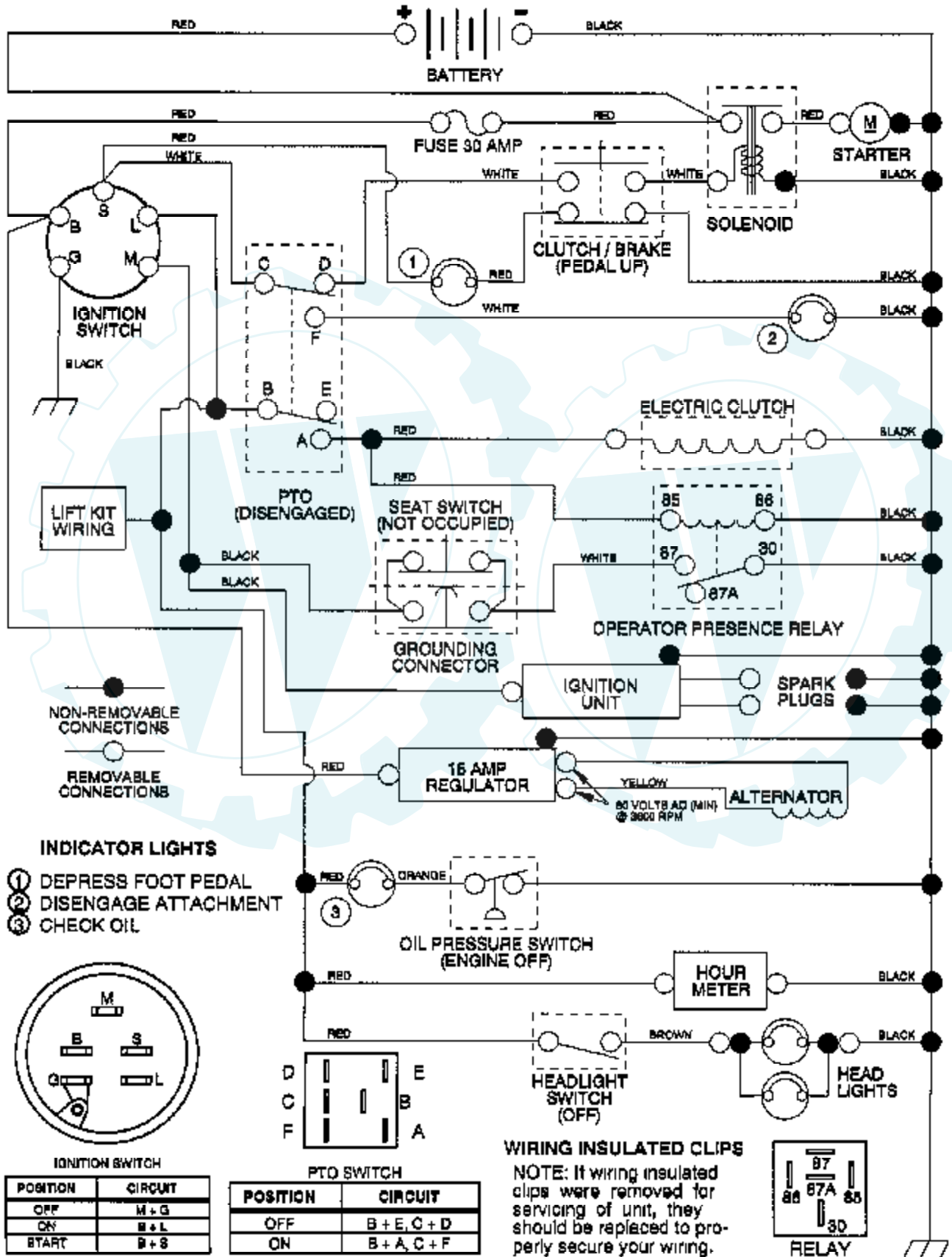









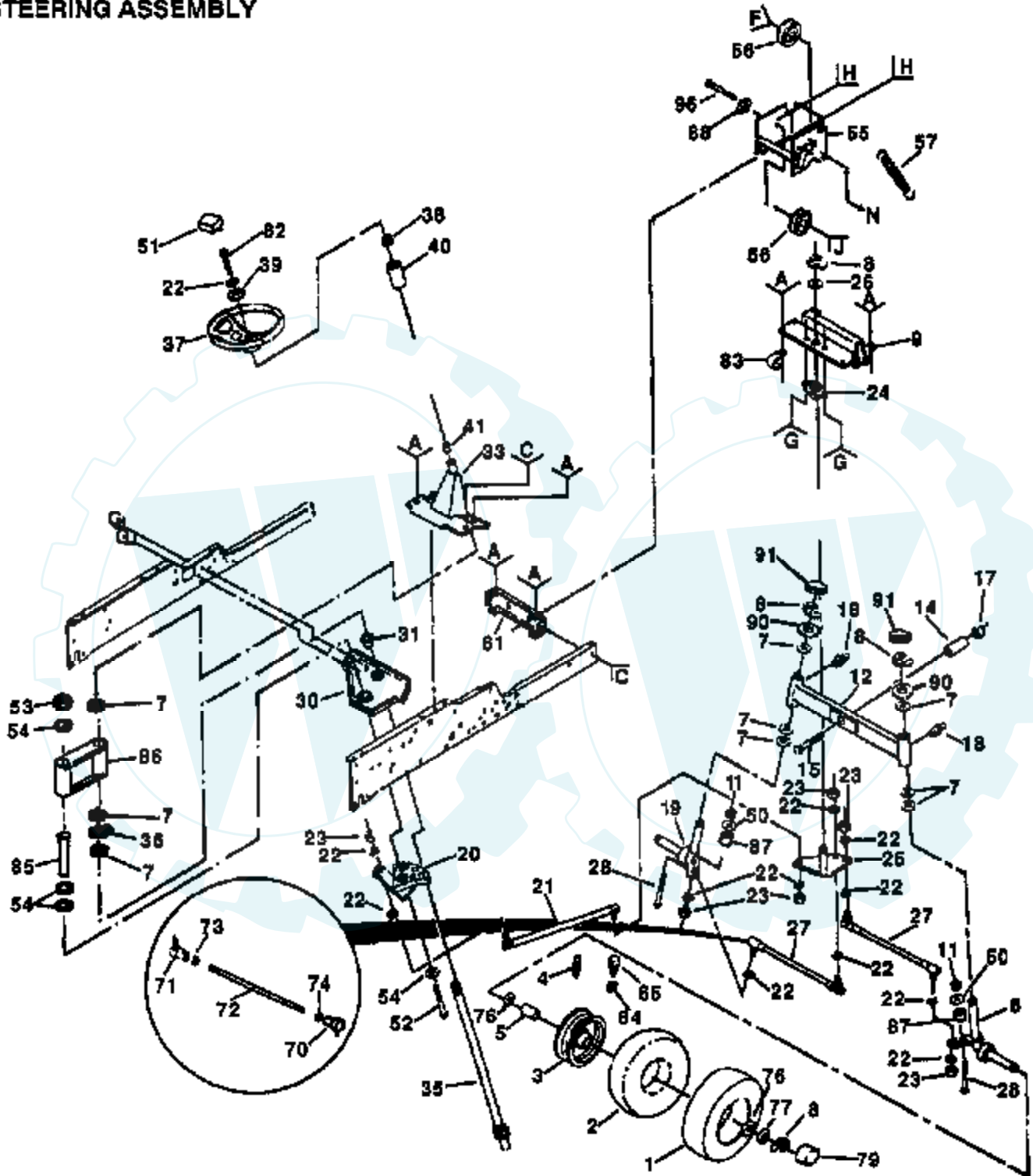













Ref #	Part Number	Qty	Description
1	139099		NLA
2	139098		NLA
3	135437		NLA
4	135436		NLA
5	133796		DECAL
6	4900J		DECAL T
7	121343X		DECAL WARING
8	135971		DECAL.STRG.WHL
9	136794		SUB= 138955
10	108367X		DECAL T
11	135438		PLATE.NAME.SMALL
12	138448		DECAL.PANEL.SIDE
	138753		MANUAL.O.TS2051A



20 HP 50" TRACTOR - - MODEL NUMBER TS2051A

STEERING ASSEMBLY



- | | | | | | | |
|---|---|---|---|---|---|---|
| A | C | F | G | H | J | N |
|  |  |  |  |  |  |  |
|  |  |  |  |  |  |  |
| |  |  | |  | |  |
| |  | | |  | |  |

Ref #	Part Number	Qty	Description
1	106230X		SUB= 122075X
2	8134H		TUBE.16X6.5/7.5-8
3	106228X361		SUB= 106228X417
4	278H		FITTING LT
5	9040H		"FLANGE, BEARING"
6	106045X		SPINDLE RH T
7	6266H		WASHER .T
8	12000029		RING
9	5284J		AXLE BRACKET T
10	74760612		SUB= 74780612
11	73680600		SUB= 73690600
12	137094		SUB= 532137094
14	136518		SPACER BEARING
15	74781044		BOLT
17	73681000		LOCKNUT M
18	6855M		ZERK M
19	106046X		SPINDLE ASSY T
20	120424X		SECTOR T
21	110497X		LINK.DRAG.T
22	10040600		LOCKWASHER
23	73610600		SUB= 7810H
24	5292J		SUB= 140342
25	108137X		"T, BELLCRANK"
26	19292016		WASHER
27	109849X		TIE ROD T
28	74520628		BOLT
29	102933X		SPLIT SPACER YTV
30	102439X		SUB= 144668
31	104239X		"FLANGE GT, BEAR."
33	101274N		SUPPORT ASSY T
34	17490612		SCREW
35	104591X		SHAFT STEERING GT
36	12000034		KLIP RING
37	133741		SUB= 150547
38	100711L		ADAPTER LT
39	19133808		WASHER T
40	106014X		SLEEV-STEERIN T
41	9038R		"T, BEARING"
50	19131212		WASHER T
51	133742		ST WHL INSERT CAP
52	74780880		BOLT T
53	73680800		NUT LTV
54	19172610		WASHER GT
55	120542X		IDLER BRKT T
56	677A451		IDLER-INSIDE T
57	7190J		SPRING
58	74760636		BOLT
59	19131413		WASHER
60	73220600		NUT.HEX.3/8-16UNC
61	5213J		FRAME BRACKET GT
62	73680500		SUB= 73690500
64	65139		VALVE STEM LT
65	59192		VALVE CAP
68	106615X		SUB= 677A928
70	109850X		JOINT.RH
71	109851X		JOINT.LH
72	7919J		SUB= 121159X
73	73700600		NUT

Ref #	Part Number	Qty	Description
74	73360600		NUT
76	121749X		WASHER
77	121748X		WASHER
78	74930516		BOLT GT
79	104757X		HUB CAP
80	100644K		BUSHING LT
81	19111416		WASHER
82	74780616		BOLT
83	100207K		CLIP GTV
85	120199X		TUBE T
86	121177X		COLLAR
87	101496X		SPACER LT
88	19132007		WASHER T
90	121748X		WASHER
91	121232X		CAP
96	74760632		SUB= 74930632

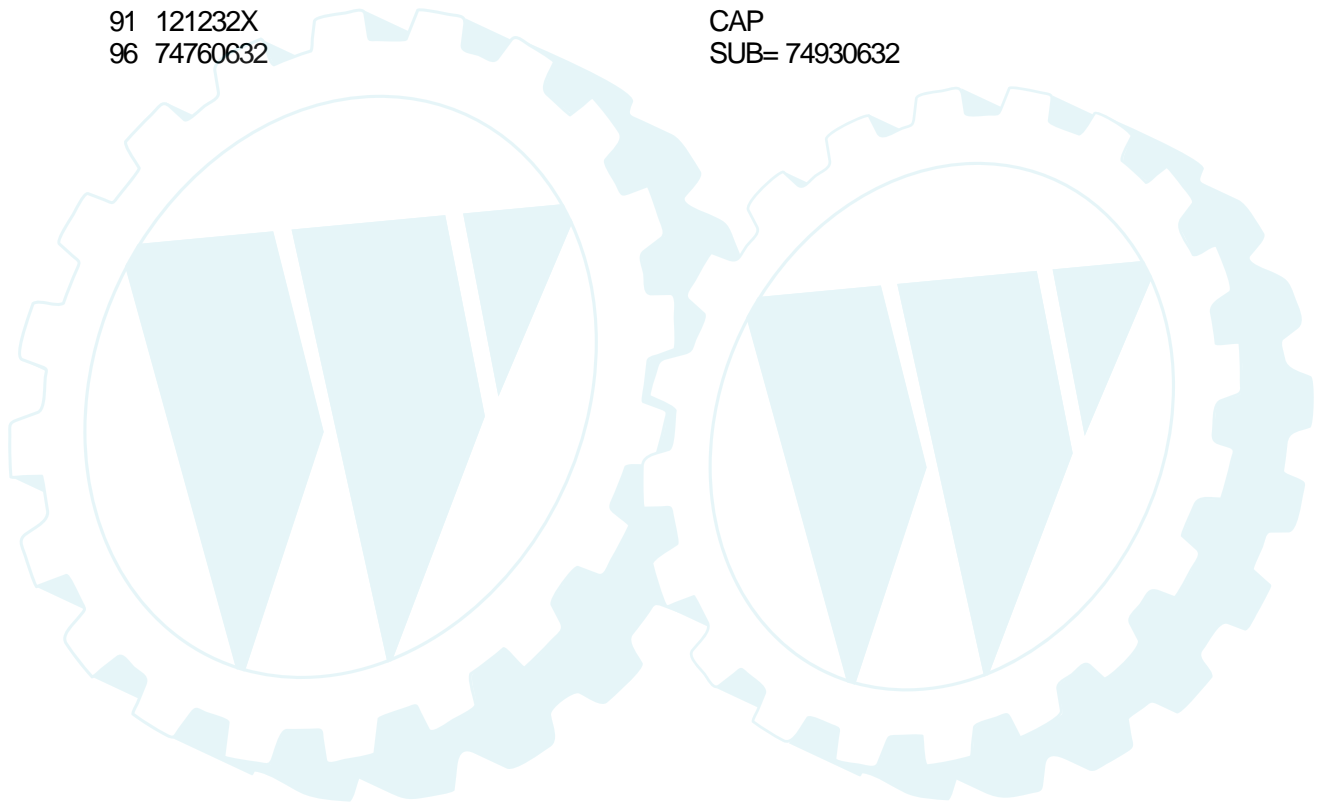

20 HP 50" TRACTOR - - MODEL NUMBER TS2051A

TRANSAXLE

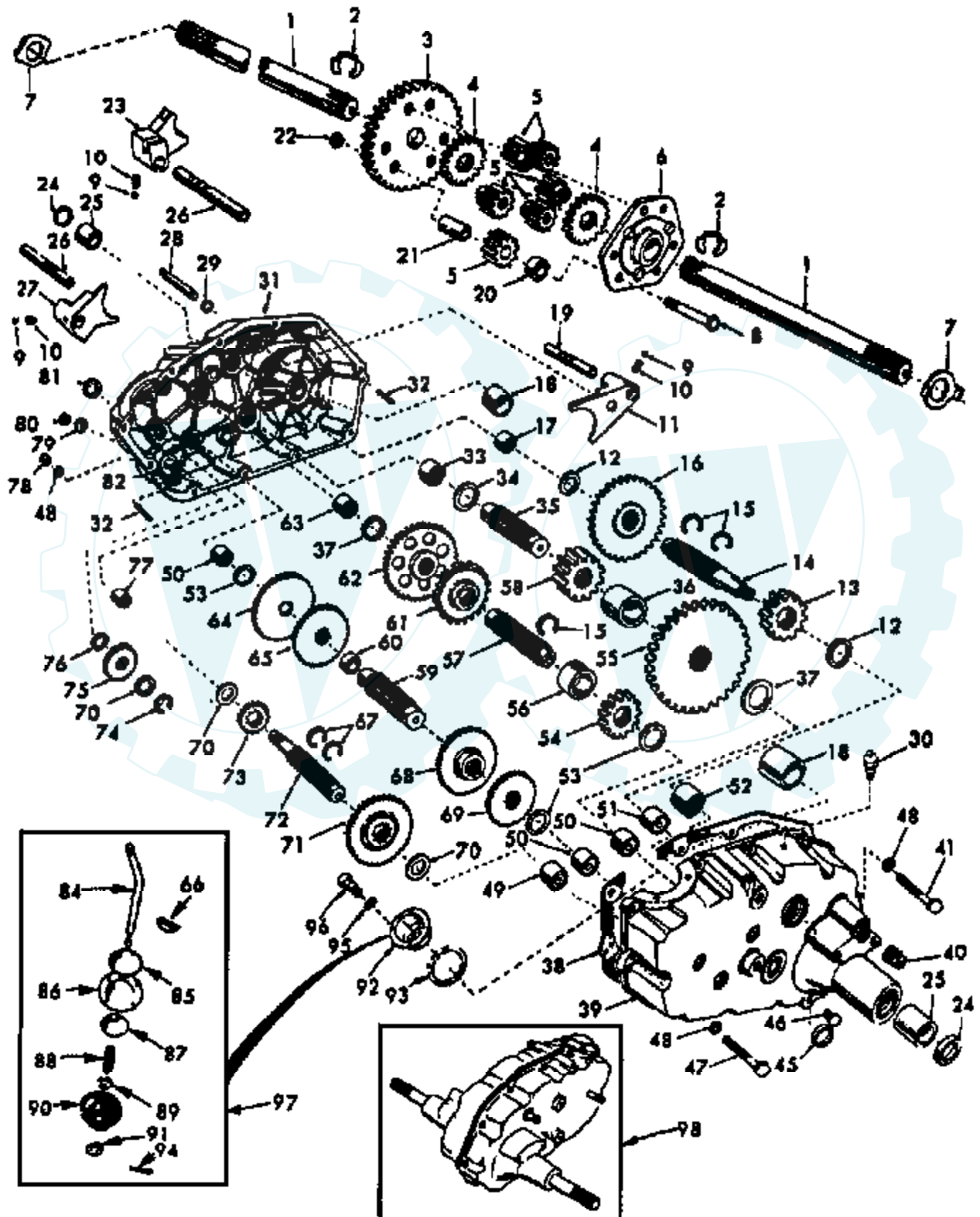

Ref #	Part Number	Qty	Description
1	4197R		SHAFT.AXLE.T
2	12000034		KLIP RING
3	4199R		FINAL GEAR T
4	4216R		DIFF GEAR T
5	4215R		DIFF PINION T
6	4217R		DIFF CARRIER T
7	6256H		WASHER T
8	74020652		BOLT
9	7392M		SUB= 100482K
10	137261		SUB= 145359
11	4985R		SHIFT FORK T
12	6266H		WASHER .T
13	4212R		RED PINION T
14	4196R		GEAR SHAFT T
15	6276H		SNAP RING T
16	633A63		GEAR T
17	8118M		"T, BEARING"
18	8740H1		BEARING
19	122238X		SHAFT
20	4218R		SPACER T
21	6252H1		PINION RS
22	7810H		GRIPCO NUT
23	6262H		FORK T
24	7393R		OIL SEAL STD
25	992R1		BRNG. T
26	6216H		SHAFT T
27	4986R		SHIFT FORK T
28	122254X		SHIFT SHAFT
29	6269H		SEAL T
30	5855H		VALVE M
31	137976		SUB= 532137976
32	6277H		PIN T
33	4225R		NEEDLE BRNG T
34	7396H		RACE T
35	4198R		GEAR SHAFT T
36	4200R		SUB= 532004200
37	7395H		RACE T
38	121878X		GASKET
39	137974		SUB= 532137974
40	13320400		PLUG PIPE
41	74780526		BOLT
45	6271H		SEAL T
46	13060200		SUB= 13020200
47	74780524		HEX BOLT
48	10040500		LOCKWASHER
49	4895H		"TI, BEARING"
50	4222R		NEEDLE BRNG T
51	1529R		NEEDLE BRNG T
52	8119M		"STD, BEARING"
53	4220R		BRNG RACE
54	4209R		RED PINION T
55	4213R		RED GEAR T
56	4442R		PINION SPACER T
57	4195R		GEAR SHAFT T
58	4214R		FINAL PINION T
59	4194R		GEAR SHAFT T
60	7528R		SPACER T
61	4208R		RED PINION T

Ref #	Part Number	Qty	Description
62	4207R		RED GEAR T
63	7398H		RACE T
64	4203R		LOW SPEED GEA T
65	4204R		REVERSE GEAR T
66	2898J		KEY T
67	4926H		RING STD
68	4205R		INTERMED GEAR T
69	4206R		SUB= 532004206
70	1370H		"T, BEARING"
71	633A69		CLUSTER GEAR T
72	208J		INPUT SHAFT T
73	4201R		LO SPEED PINION T
74	12000002		SUB= 2225J
75	1153R		IDLER GEAR T
76	7392H		WASHER T
77	3990H		BRNG T
78	73220500		NUT.HEX.5/16-18
79	1167R		WASHER T
80	73360700		NUT
81	6270H		SEAL STD
82	7384H		SHAFT T
84	5384J		GEAR SHIFT LVR T
85	2978J		CAP T
86	633A85		COVER AND PIN T
87	8739H1		GUIDE BALL T
88	4924H		SPRING TI
89	19151516		WASHER
90	110542X		SEAL T
91	19181511		WASHER
92	75J		GEAR SHIFT GA T
93	6274H		GASKET T
94	76020412		COTTER PIN
95	10040500		LOCKWASHER
96	74760514		BOLT
97	633A109		GEAR SHFT LVR T
98	137973		SUB= 137982