

ROPER GT TRACTOR—MODEL NUMBERS GT180ER AND GT180ET

ELECTRICAL

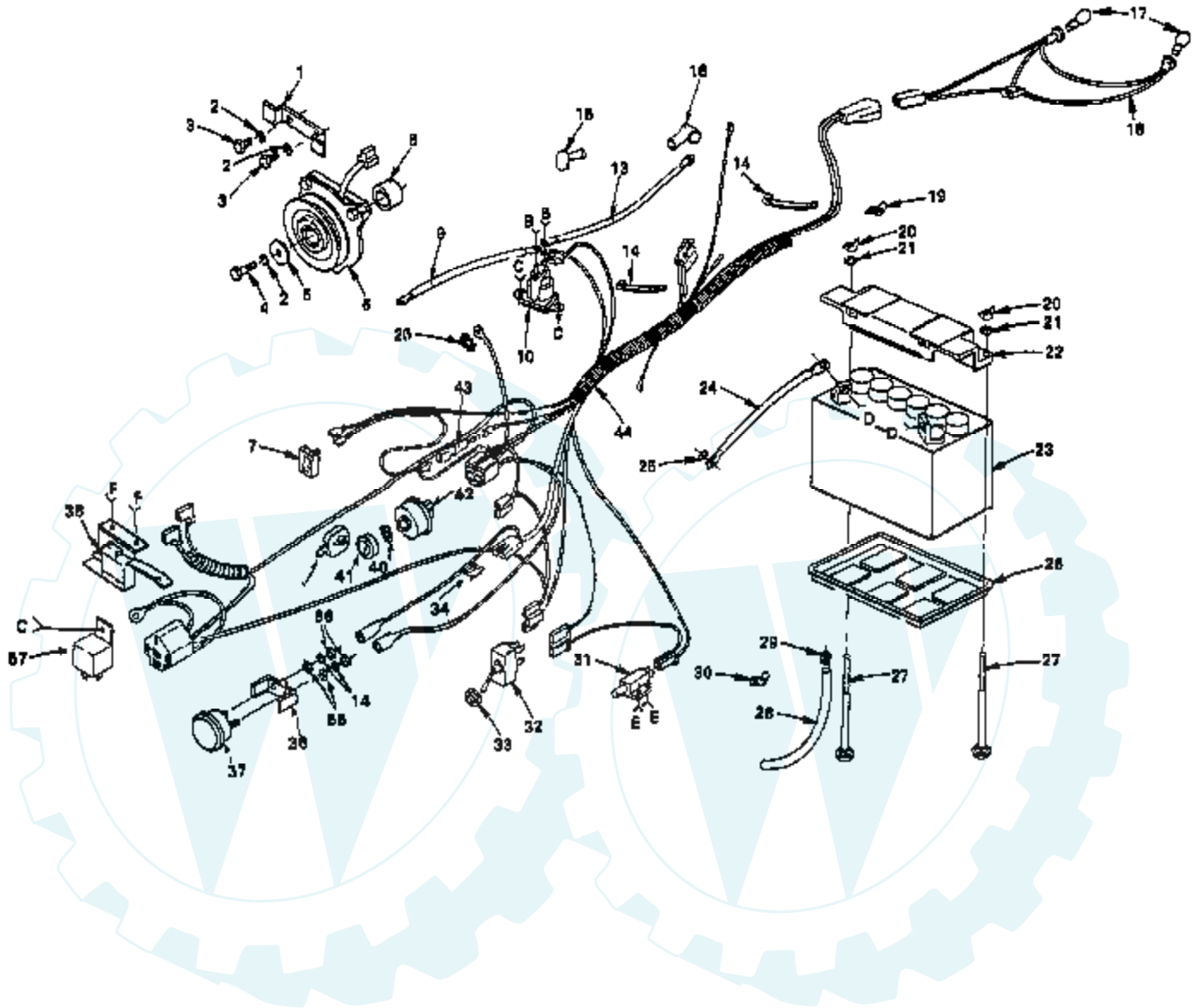

Ref #	Part Number	Qty	Description
1	108170X		STOP CLUTCH T
2	10040600		LOCKWASHER
3	74780612		BOLT
4	74610628		BOLT
5	19132203		WASHER GT
6	109550X		CLUTCH.ELECTRIC.T
7	110712X		SWITCH LT
8	106367X		SPACER-CLUTCH GT
9	4206J		CABLE-BATTERY T
10	109081X		SUB= 146154
13	5115J		SUB= 5114J
14	10101000		SUB= 10071000
16	719J		SUB= 154336
17	7662J		SUB= 4152J
18	110859X		HARNESS T
20	73490400		SUB= 146525
21	11030400		LOCKWASHER GT
22	102476X		SUB= 150109
23	227J		SUB= 123899X
24	4207J		CABLE T
26	7603J		"TRAY T, BATTERY"
27	72240460		BOLT
28	100541K		SUB= 7697J
29	109596X		HOSE CLAMP T
30	100207K		CLIP GTV
31	104445X		SWITCH-INTER. GT
32	4021J		SWITCH.PTO.T
33	4022J		HEX NUT T
34	6347R		FUSE-30 AMP
36	6009J		SUB= 532131708
37	9433R		AMMETER T
38	121064X		SWITCH T
40	109788X		SUB= 124211X
41	109787X		SUB= 147626
42	4406R		SUB= STD365402
43	106315X		SUB= 135665
44	120324X		HARNESS T
55	19070818		WASHER
56	73911000		NUT
57	109748X		RELAY ASSY T
	101539X		SHEET INSTR LT
	110918X		MANUAL T
	120612X		OWNER'S MANUAL (FRENCH)

ROPER GT TRACTOR-MODEL NUMBERS GT180ER AND GT180ET

FRAME, FENDER AND DRAWBAR

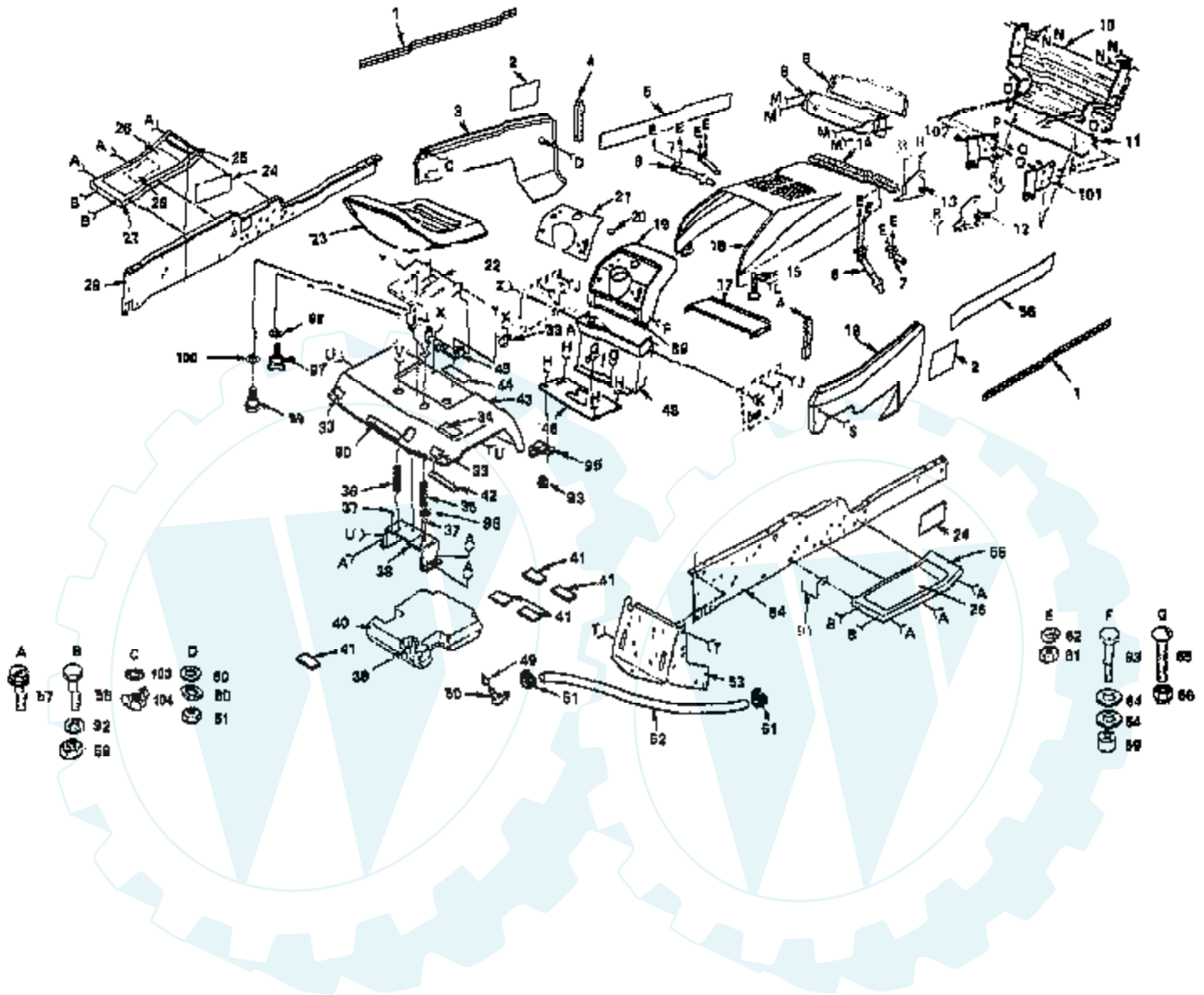

Ref #	Part Number	Qty	Description
1	104646X		NLA
2	104639X		NLA
3	108372X388		SUB= 150302X505
4	106088X		FOAM STRIP T
5	104643X		NLA
6	106784X		SUB= 155013
7	104618X		SUB= 155013
8	104613X		SUB= 147717
9	106395X		LENS LT
10	104628X		GRILL GT
11	105419X388		NLA
12	110853X		SUPPORT RH YTH
13	110852X		SUPPORT LH YTH
14	109458X		FOAM STRIP T
15	109808X		HOOD LATCH T
16	108371X388		SUB= 140679X505
17	7985J		SUB= 140229
18	108370X388		SUB= 150301X505
19	106796X		DASHBOARD T
20	8022J		PLUG-DASH T
21	110790X		NLA
21	110970X		NLA
22	121069X		SUB= 155925
23	110840X		SUB= 140121
24	104640X		NLA
25	4900J		DECAL T
25	101892X		DECAL T
26	109864X		SUB= 108256X
27	105465C388		SUB= 105465X388
28	106868X		DECAL T
29	110893X		SUB= 151630
33	106202X		REFLECTOR-TAIL YT
33A	2751R		CLIP T
34	7178J		DECAL-CAUTION
34	101893X		NLA
35	121067X		SPRING T
36	121068X		SPRING T
37	105531X		NUT-PUSH YT
38	105509X		SUB= 137113
39	109462X		SUB= 158990
40	106020X		SUB= 151346
41	106082X		PAD-SPACER LT
42	105511X		SUB= 140675
43	109593X388		SUB= 121642X417
44	106974X		SUB= 133796
44	108658X		SUB= 120822X
45	105513X		SUB= 140551
46	106042X		SUB= 106042X012
48	104608X		DASH ASSEMBLY
49	3645J		BUSHING OUTLET T
50	8710J		FUEL TANK STEM GT
51	6999R		SUB= 123487X
52	7834R		SUB= 8542R
53	7982J		SUB= 140506
54	110892X		SUB= 150383
55	105464X388		FOOTREST-R.H.
56	104644X		NLA
57	17490612		SCREW

Ref #	Part Number	Qty	Description
58	74760612		SUB= 74780612
59	73680600		SUB= 73690600
60	19091216		WASHER PM
61	73220400		SUB= 50675
62	10090400		SUB= 10040400
63	74760616		BOLT
64	19131316		WASHER
65	74180512		SCREW
66	73680500		SUB= 73690500
89	108456X		SUB= 138955
89	108456X		SUB= 138955
89	108813X		SUB= 138956
90	104810X		NLA
91	105500X		BELT RETAINER GT
92	19131312		WASHER
93	109641X		GROMMET T
95	4171R		CLIP T
97	120068X		"KNOB 1/2" YT"
98	19171920		SUB= 19171720
99	121094X		BOLT T
100	19151616		SUB= 19171616
101	110855X		SUPPORT LH YTH
102	110854X		SUPPORT RH YTH
103	11030400		LOCKWASHER GT
104	73490400		SUB= 146525

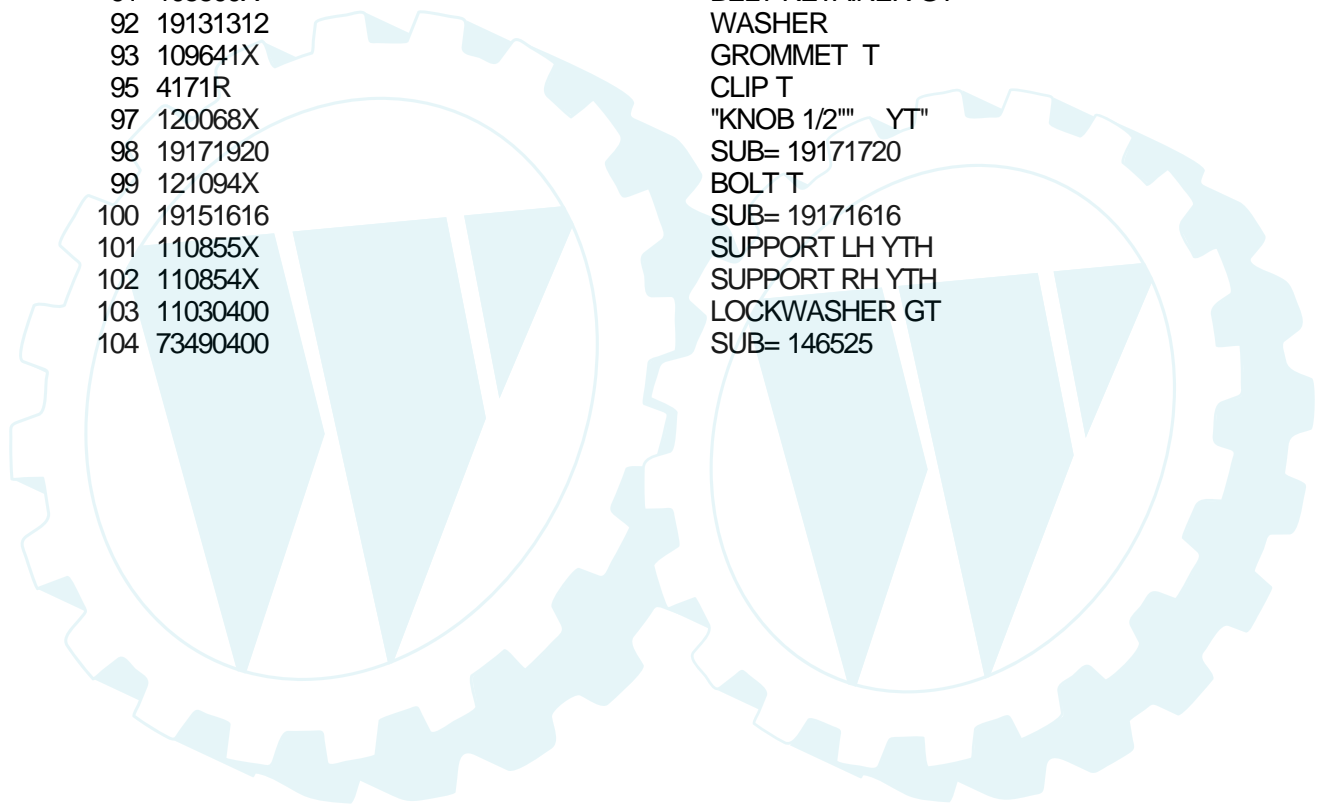

ROPER GT TRACTOR--MODEL NUMBERS GT180ER AND GT180ET

GROUND DRIVE

- A 87
88
89
- B 87
88
89
- C 93
84
85
- D 96
97
- E 98
91
92
- F 100
45
- G 101
94
- H 102
104
- I 103
105
- J 107
45
- K 101
45
- L 71
111
45

- M 108
111
45
- N 126
110
45
- O 107
112
17
94
113
- P 114
115
- Q 116

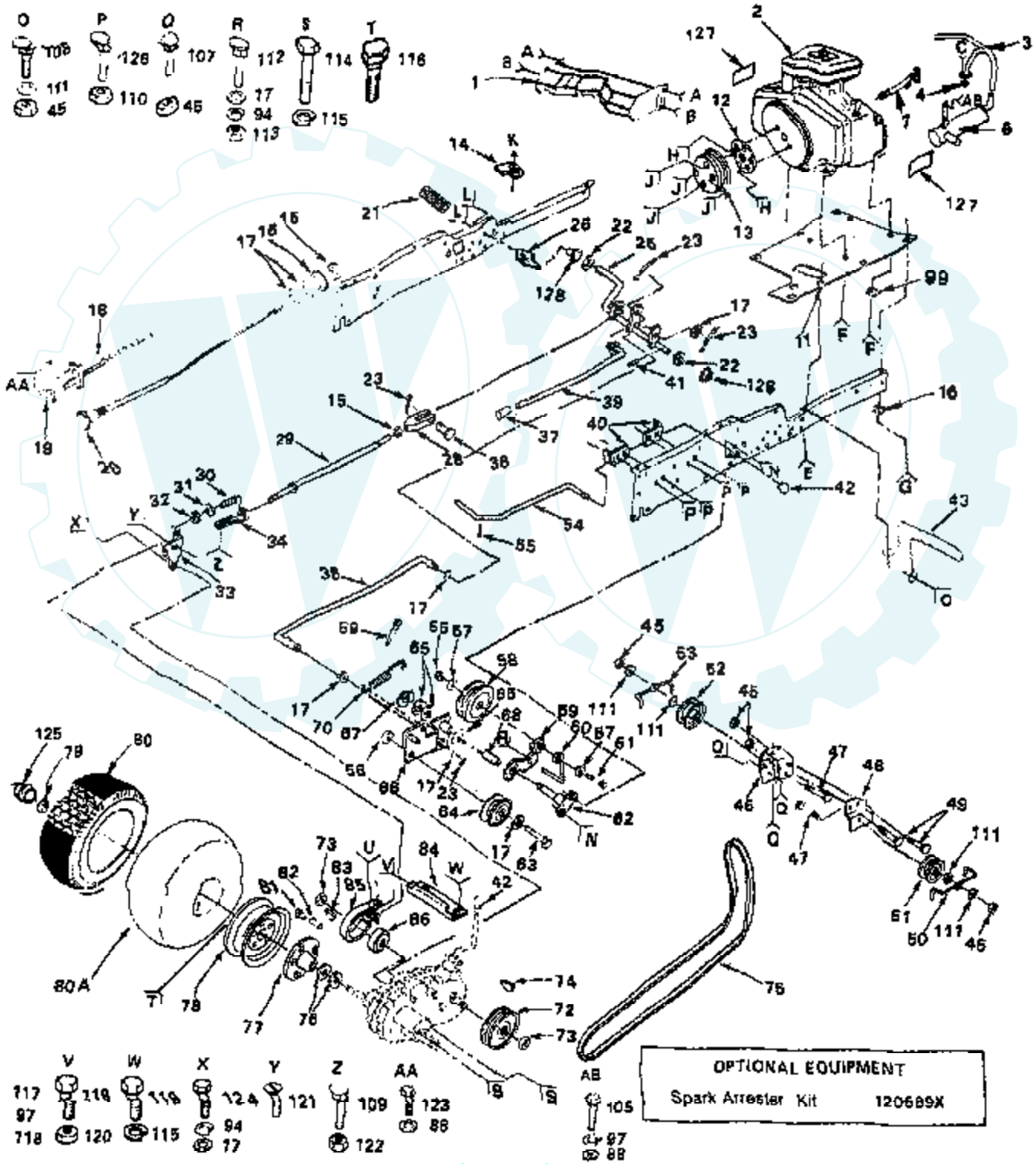

- R 117
97
118
- S 118
119
115
- T 124
94
17
- U 121
109
122
- V 123
88
- W 105
- X 97
88

Ref #	Part Number	Qty	Description
1	120779X		BAFFLE ASSY - ENGINE
2	110864X		ENGINE
3	120603X		NLA
4	8545J		SUB= 272250
6	120602X		SUB= 127881
7	120374X		VALVE T
11	110867X		"ENG. T, BASE"
12	104577X		ADAPTER T
13	120331X		PULLEY GT
14	5304J		ACT-SWITCH T
15	73610600		SUB= 7810H
16	11050600		LOCKWASHER
17	19131316		WASHER
18	120055X		SUB= 133439
19	61159		KNOB
20	120056X		SUB= 132779
21	8883R		PEDAL COVER T
22	19252016		SUB= 121749X
23	76020312		SUB= 3145
25	104375X		SHAFT ASSY GT
26	104601X		BRKT SWITCH GT
28	100604K		YOKE GTV
29	5308J		BRAKE ROD T
30	7241J		SPRING T
31	19131614		WASHER
32	73530600		SUB= 7810H
33	677A637		BRAKE BRKT ASSY T
34	7229J		GUIDE ROD T
35	101356L		ROD CLUTCH GTV
36	5102J		CLEVIS PIN T
37	71673		PLUNGER CAP T
39	109767X		SUB= 136284
40	105598X		ROD BRACKET GT
41	5142H		ROLL PIN STD
42	100196K		SUB= 106932X
43	108885X		GUARD MUFFLER HYT
45	73680600		SUB= 73690600
46	121063X		SUB= 139995
47	72110616		BOLT
48	121065X		BRACKET T
49	72140606		BOLT
50	120157X		BELT GUARD T
51	102403X		IDLER-FLAT T
52	101344L		PULLEY V IDLR GTV
53	120158X		SUB= 106023X
54	101345M		ROD SHIFT GTV
55	76020616		SUB= 76020624
56	73930600		LOCKNUT
57	19131413		WASHER
58	104360X		SUB= 131494
59	101347L		BRACKET GTV
60	105597X		BELT RETAINER GT
61	74760632		SUB= 74930632
62	101358K		BRACKET ASSY GTV
63	74760624		SUB= 74930624
64	110488X		SUB= 110484X
65	207J		WASHER T
66	105592X		CLUTCH BRACKET GT

Ref #	Part Number	Qty	Description
67	12000039		KLIP RING
68	101350K		"GTV, BEARING"
69	76020816		COTTER PIN
70	101355X		SPRING GTV
71	74780620		BOLT
72	120332X		PULLEY GT
73	9204H		NUT STD
74	9858M1		KEY
75	110883X		BELT-V.98.5.GD.DV
76	7563R		WASHER T
77	634A692		SUB= 149176X431
78	106277X		SUB= 106277X417
79	12000034		KLIP RING
80	4607R		SUB= 122077X
80A	7154J		TUBE.23X8/10-12
81	59192		VALVE CAP
82	65139		VALVE STEM LT
83	2228M		SUB= 2228M1
84	120404X		SUB= 156404
85	7920J		SUB= 101122M
86	214J		BRAKE DRUM T
87	74780412		SUB= 74780414
88	19091016		WASHER
89	73680400		SUB= 73690400
90	72010510		BOLT
91	10040500		LOCKWASHER
92	73220500		NUT.HEX.5/16-18
94	10040600		LOCKWASHER
95	19131210		WASHER
96	74570412		SCREW GTV
97	10040400		LOCKWASHER
98	74780520		BOLT
99	11050500		LOCKWASHER.5/16.E
100	74760612		SUB= 74780612
101	74780616		BOLT
102	17190512		SCREW T
103	74321016		SCREW
104	73631000		SUB= 69180
105	74760412		BOLT LT
107	72110606		BOLT
108	72140610		BOLT.3/8-14X1.25
109	72110506		SUB= 72270506
110	73680500		SUB= 73690500
111	19131612		WASHER GT
112	72140608		SUB= 72110608
113	73220600		NUT.HEX.3/8-16UNC
114	74760724		BOLT
115	10040700		LOCKWASHER
116	1304H		SUB= 140080
117	72140405		BOLT T
118	73220400		SUB= 50675
116	74760716		BOLT
117	72140405		BOLT T
118	73220400		SUB= 50675
119	74760716		BOLT
120	73680700		NUT GTV
121	74370612		SCREW
122	1385H		

Ref #	Part Number	Qty	Description
123	17720408		SCREW
124	74760614		SUB= 74760616
125	104758X		CAP-HUB GT
126	72140506		BOLT
127	110041X		NLA
128	110895X		NYLINER T
120689X	120689X	1	SPARK ARRESTER KIT

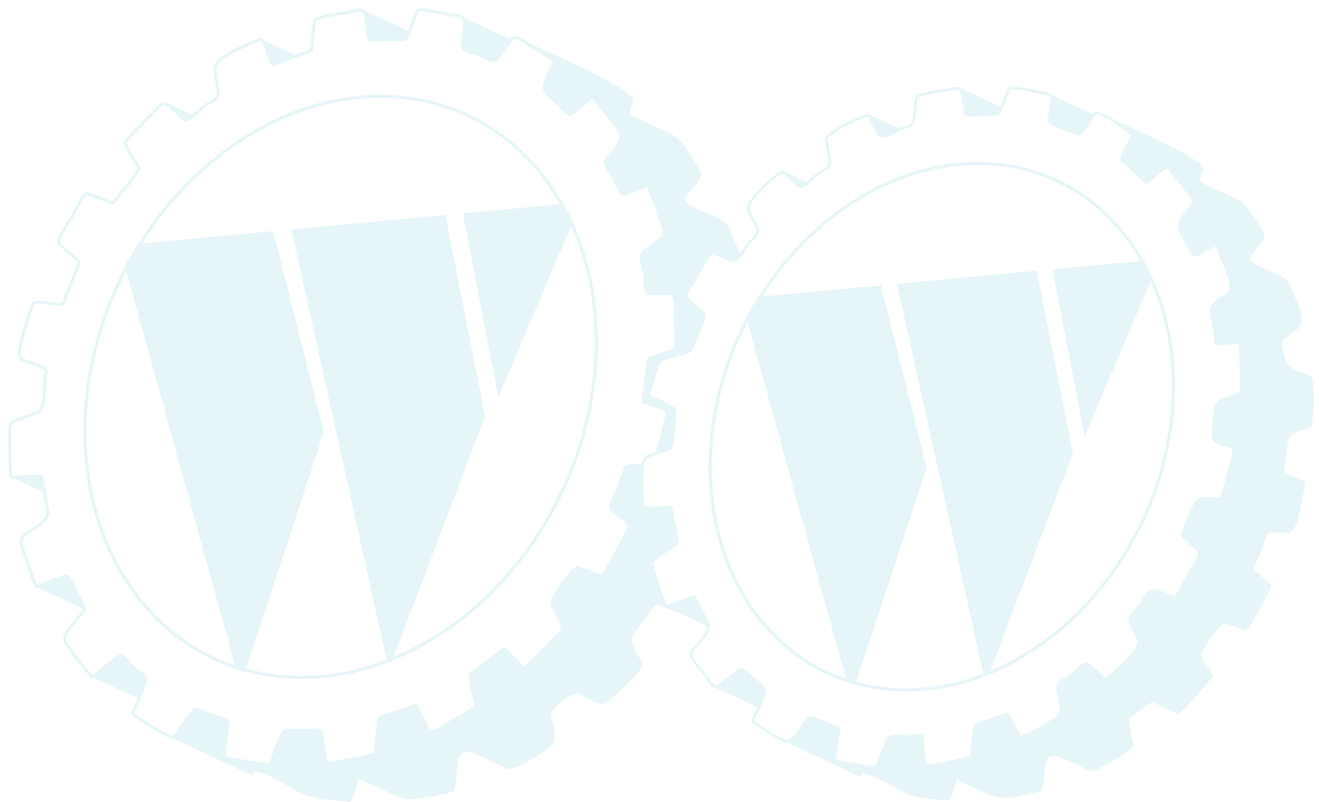

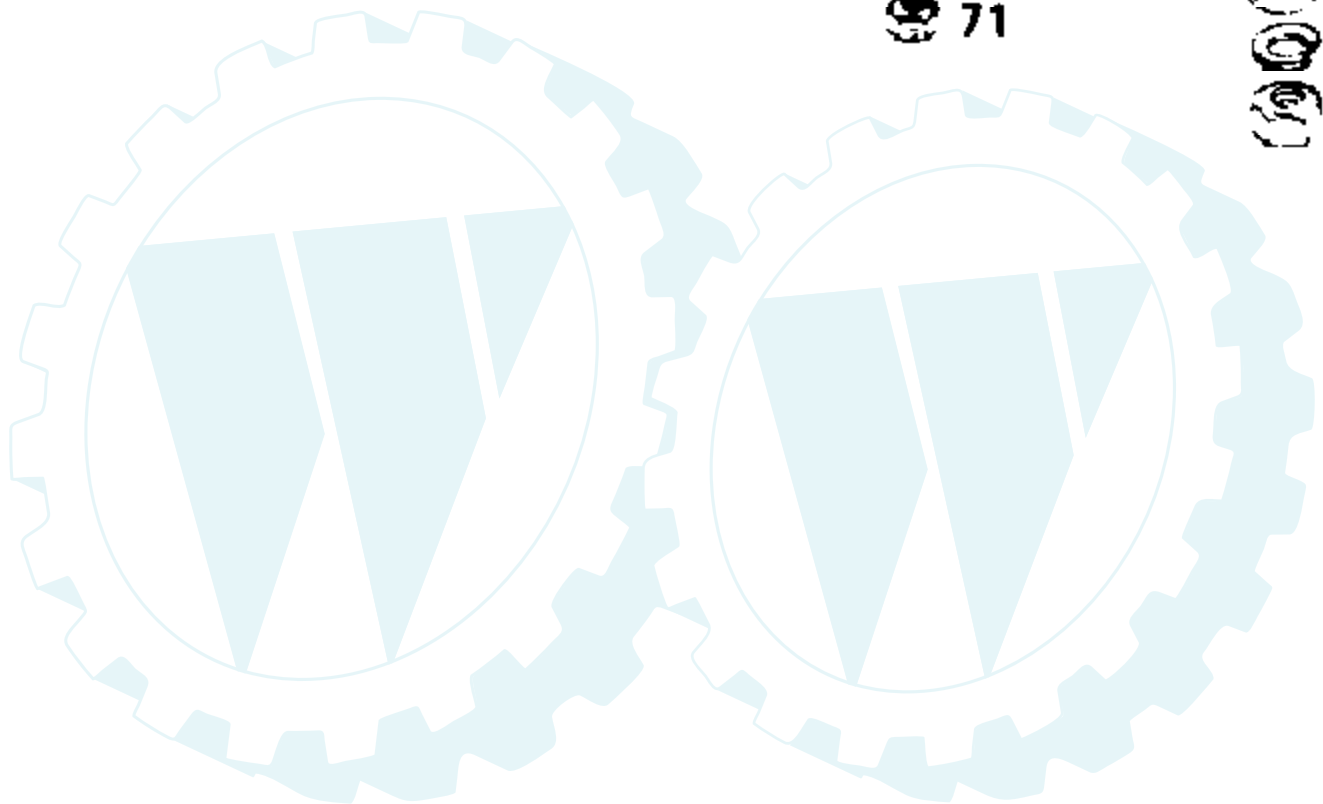
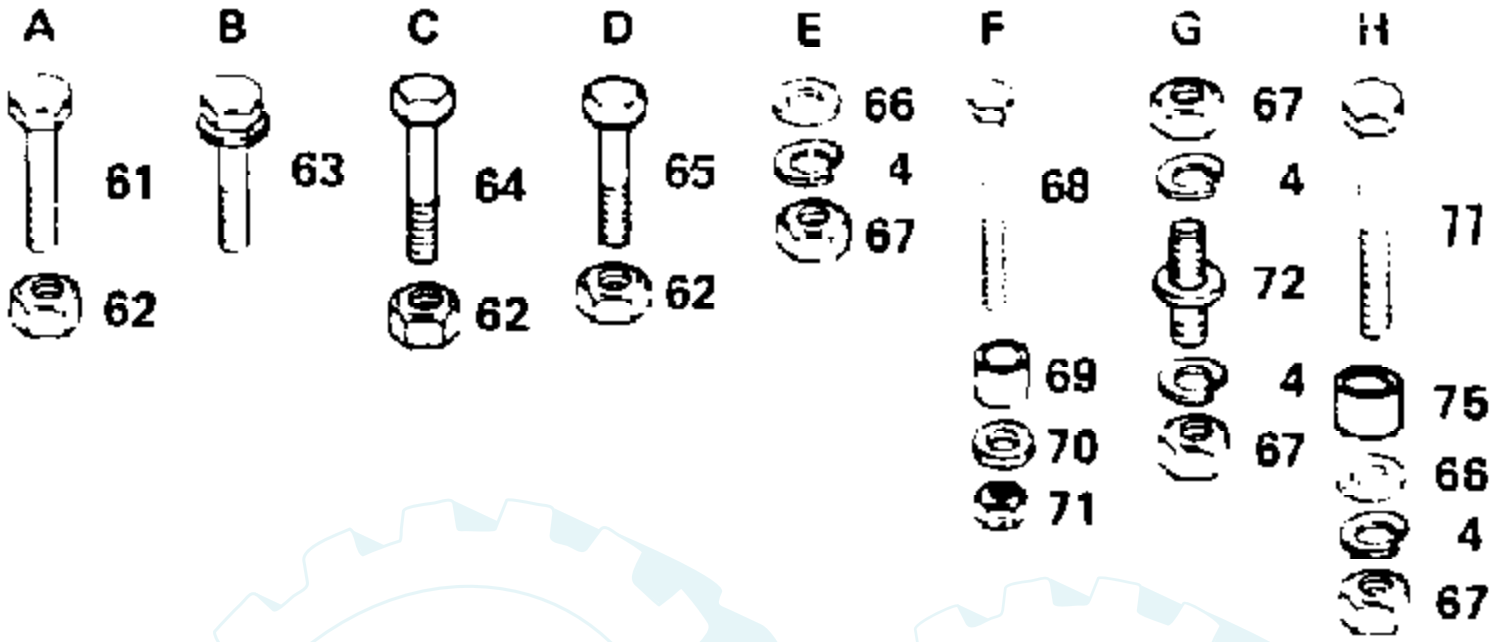

Ref #	Part Number	Qty	Description
4	10040600		LOCKWASHER
61	74760612		SUB= 74780612
62	73680600		SUB= 73690600
63	17490612		SCREW
64	74780616		BOLT
65	74760616		BOLT
66	19131413		WASHER
67	73220600		NUT.HEX.3/8-16UNC
68	74930516		BOLT GT
69	100644K		BUSHING LT
70	19111416		WASHER
72	106615X		SUB= 677A928
75	102933X		SPLIT SPACER YTV
77	74760636X		BOLT - HEX

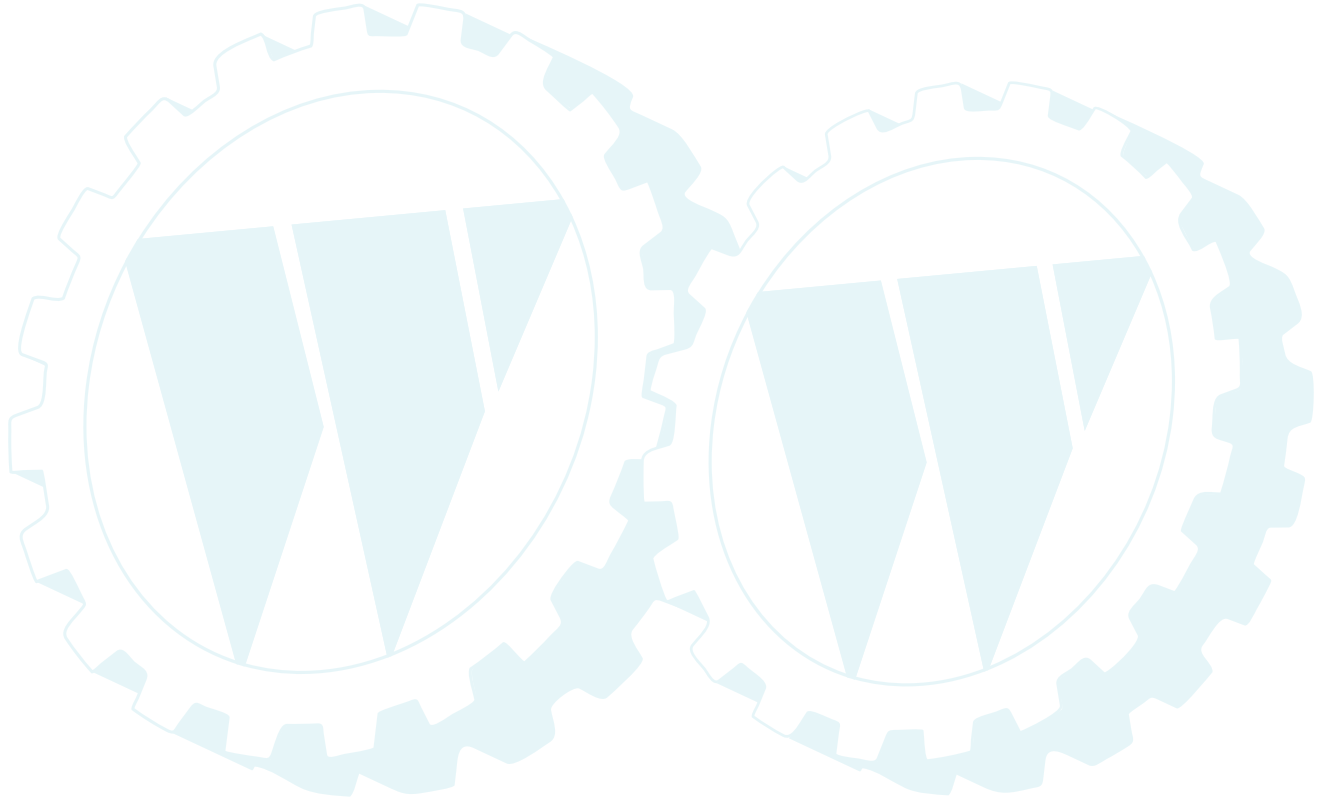

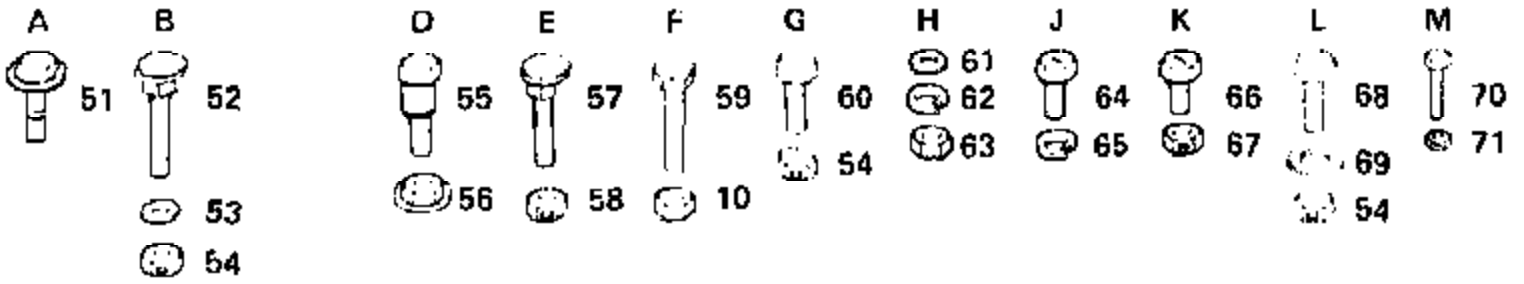

Ref #	Part Number	Qty	Description
10	73680600		SUB= 73690600
51	17490608		SCREW LT
52	72140508		BOLT
53	19111610		WASHER
54	73680500		SUB= 73690500
55	7901J		SHOULDER BOLT T
56	73900400		NUT T
57	72140606		BOLT
58	73930600		LOCKNUT
59	74760616		BOLT
60	74350512		BOLT LT
61	19091216		WASHER PM
62	10090400		SUB= 10040400
63	73220400		SUB= 50675
64	74750806		SCREW GT
65	10070800		NLA
66	74321008		NLA
67	73631000		SUB= 69180
68	74760512		BOLT
69	19111216		WASHER M
70	10040600		LOCKWASHER
71	110807X		NUT T

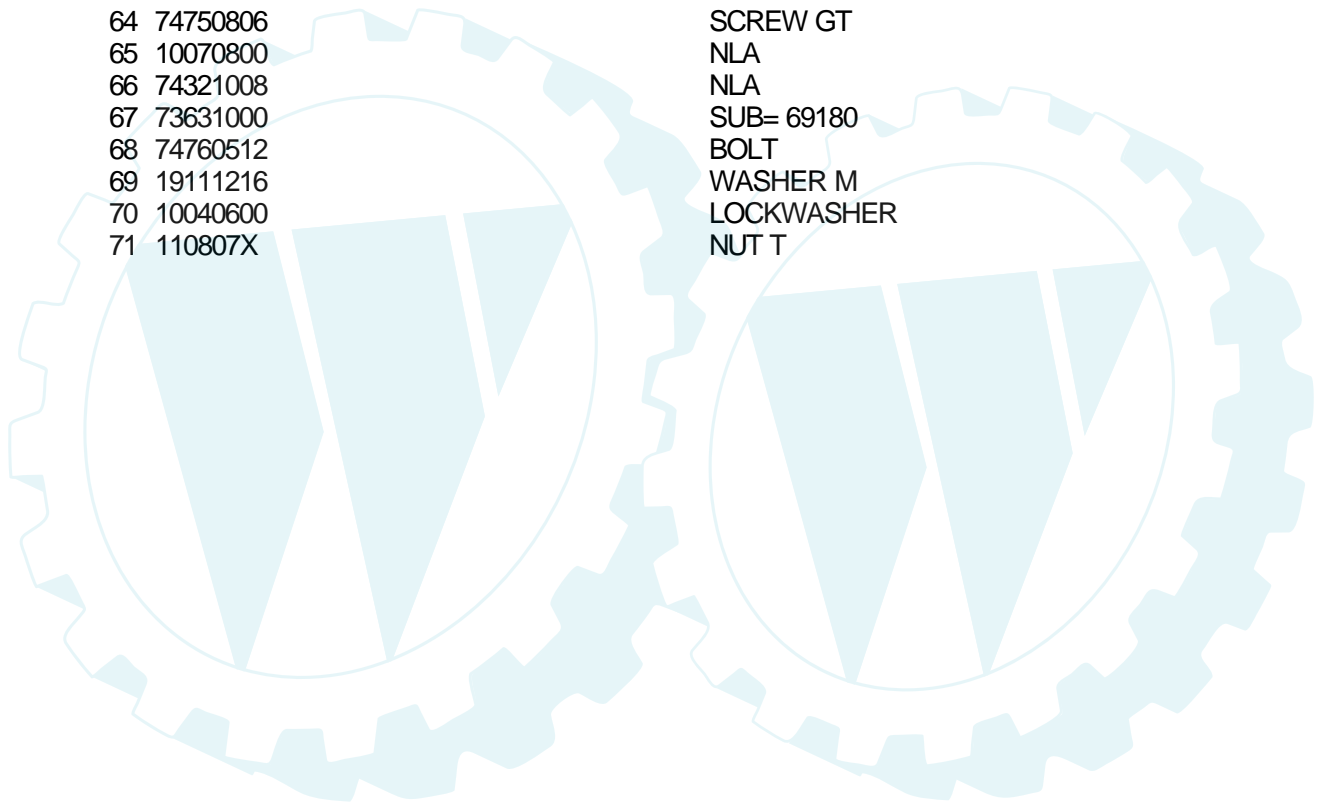

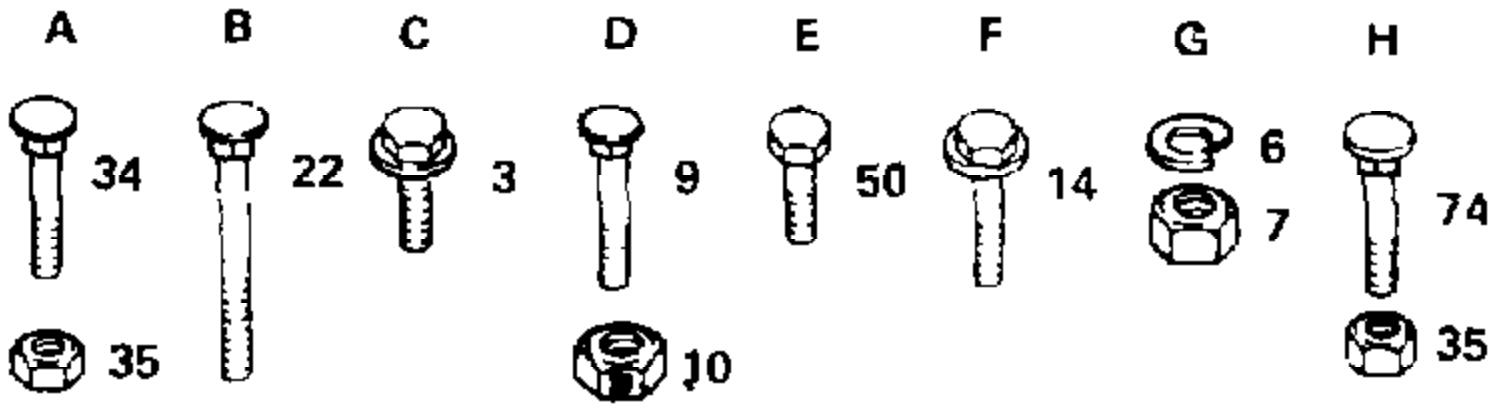

Ref #	Part Number	Qty	Description
3	17490508		SCREW LT
6	10040500		LOCKWASHER
7	73220500		NUT.HEX.5/16-18
9	72140506		BOLT
10	1685H		SUB= 68478
14	17490612		SCREW
22	72110522		BOLT
34	72240606		BOLT
35	73680600		SUB= 73690600
50	74760622		BOLT
74	72240608		BOLT



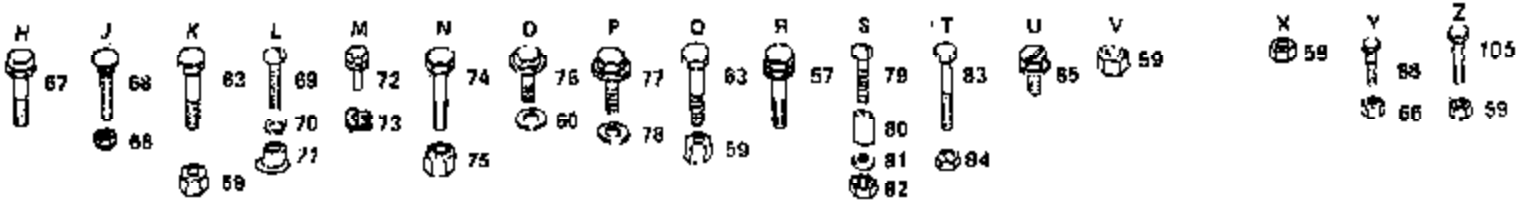

Ref #	Part Number	Qty	Description
57	17490612		SCREW
59	73680600		SUB= 73690600
60	19091216		WASHER PM
63	74760616		BOLT
66	73680500		SUB= 73690500
67	17240408		SUB= 17720408
68	72140506		BOLT
69	74191008		SCREW
70	10071000		LOCKWASHER
71	2029J		WELDNUT
72	17211010		SCREW LT
73	104755X		""J"" FASTENER LT"
74	7605J		BOLT T
75	73680400		SUB= 73690400
76	17890412		SUB= 17490412
77	17490512		SCREW
78	19111212		WASHER
79	74981020		SCREW
80	7206J		SPACER LT
81	19070818		WASHER
82	73731000		NUT
83	74760716		BOLT
84	73680700		NUT GTV
85	17490608		SCREW LT
88	105529X		SUB= 139888
105	74760620		SUB= 74780620

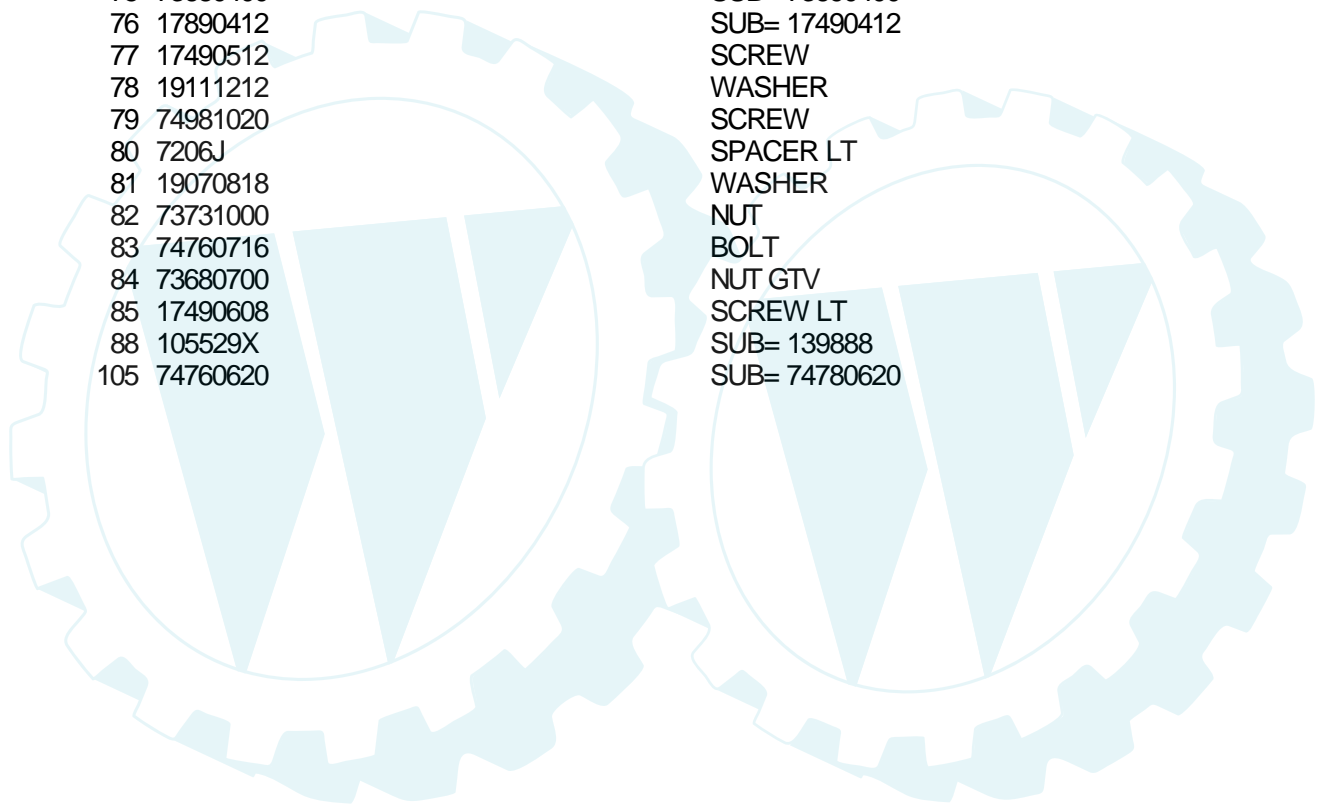

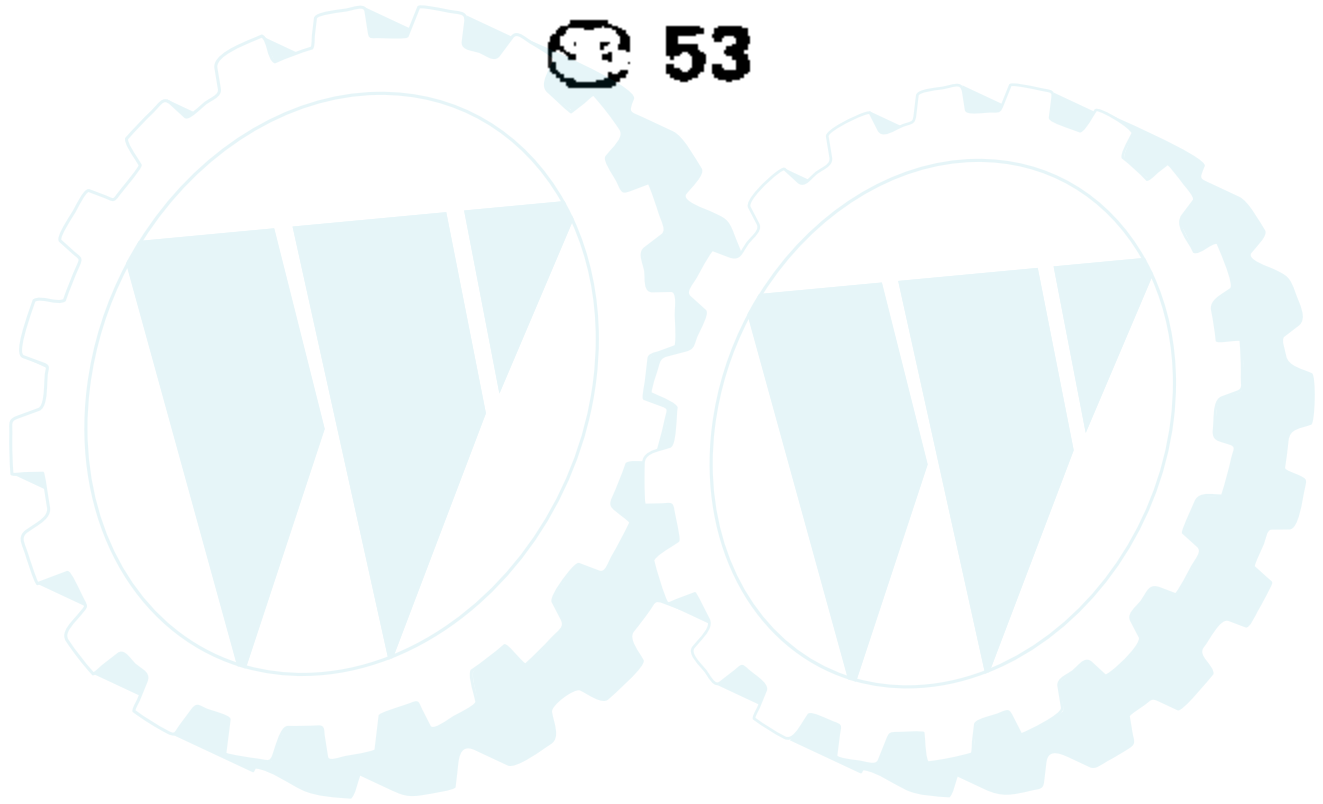
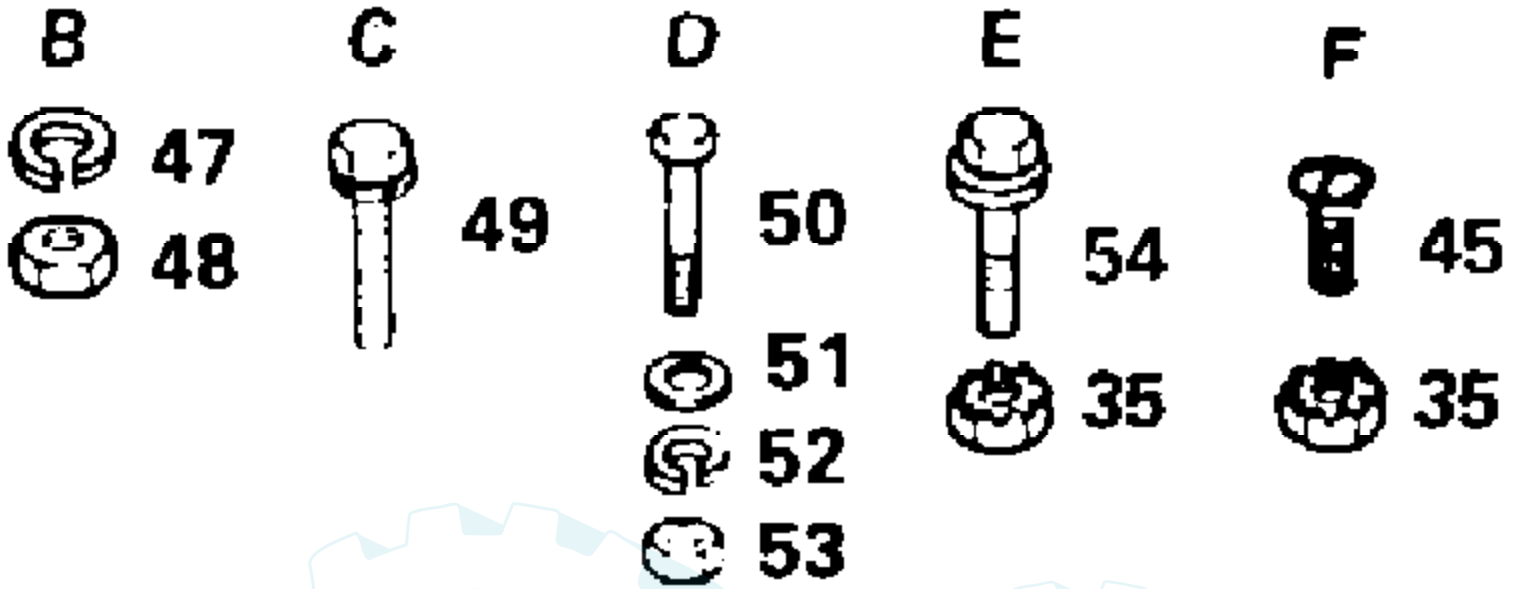

Ref #	Part Number	Qty	Description
35	73951000		"NUT,KEPS"
45	74641008		SUB= 71031008
47	10090400		SUB= 10040400
48	73350400		NUT
49	17190408		SCREW ST
50	74760412		BOLT LT
51	19091016		WASHER
52	10040400		LOCKWASHER
53	73220400		SUB= 50675
54	71031008		SCREW



ROPER GT TRACTOR--MODEL NUMBERS GT180ER AND GT180ET

MOWER

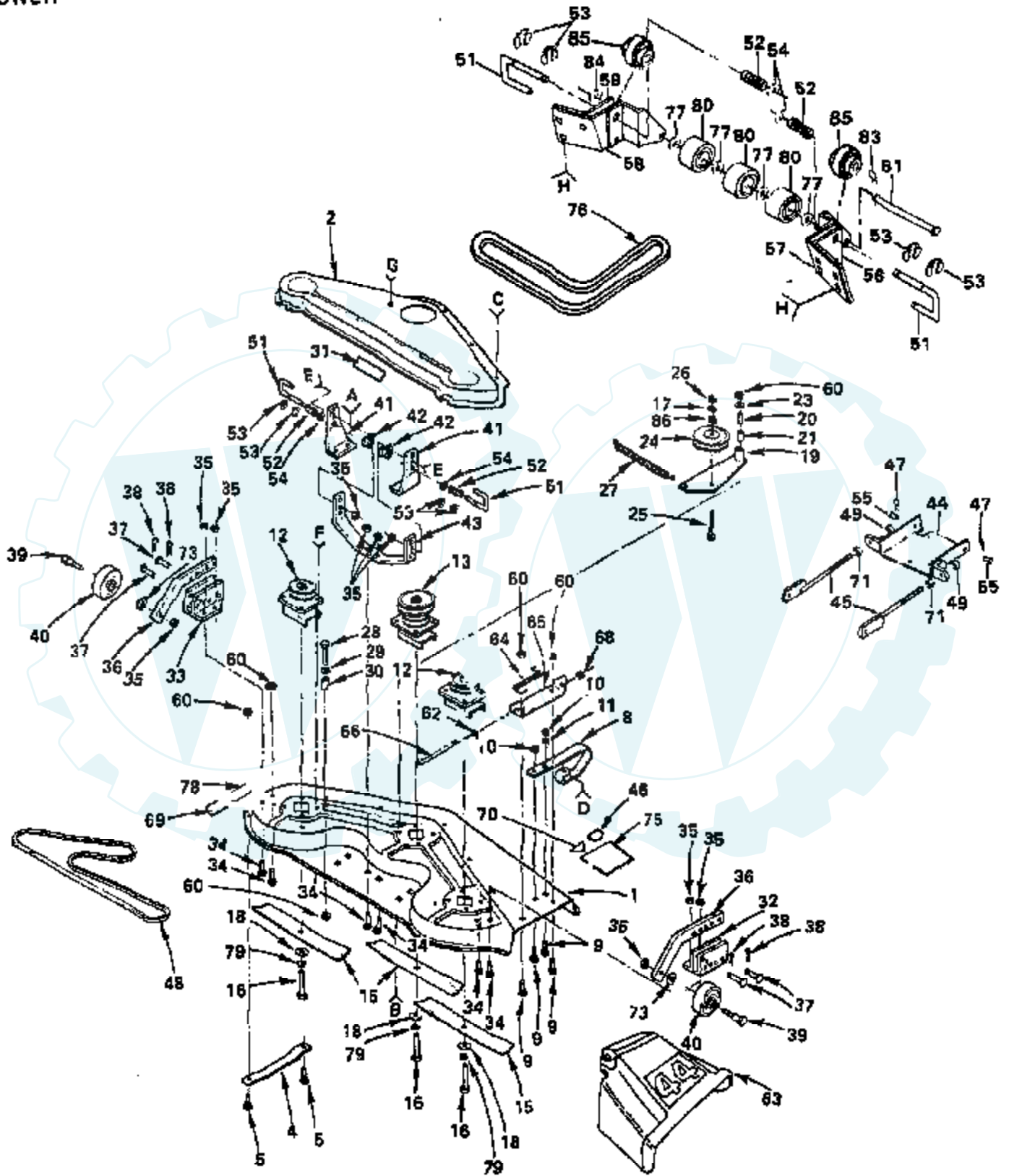

Ref #	Part Number	Qty	Description
1	105415X		SUB= 144730
2	106022X		DECK DRV COVE T
4	7631J		RUNNER-LH M
5	72110505		BOLT
8	8418J		SUB= 136321
9	72140506		BOLT
10	1685H		SUB= 68478
11	19111116		WASHER
12	105483X		SUB= 136819
13	106038X		SUB= 121657X
15	106635X		SUB= 25034
16	74610624		BOLT.3/8-24X1-1/2
17	10040600		LOCKWASHER
18	19132012		WASHER
19	674A213		ARM ASSY GT
20	7834J		SUB= 674A308
21	7835J		SUB= 674A308
23	19111610		WASHER
24	102403X		IDLER-FLAT T
25	74760624		SUB= 74930624
26	73220600		NUT.HEX.3/8-16UNC
27	104361X		SPRING T
28	74780520		BOLT
29	19111216		WASHER M
30	8438J		SPACER SPLIT LT
31	106224X		SUB= 139346
32	105448X		GUAGE WHL BRKT GT
33	105449X		GUAGE WHL BRKT GT
34	72240606		BOLT
35	73680600		SUB= 73690600
36	105453X		GUAGE WHL BAR GT
37	5565J		SUB= 139031
38	4939M		SUB= 85902
39	4898H		BOLT M
40	105455X		WHEEL.GAGE.BLK.PL
41	105433X		SUSP BRKT GT
42	110237X		SPACER GT
43	105434X		SUSP BRACE GT
44	109778X		SUB= 140741X431
45	109771X		BRACKET.SUSPEN.AS
46	78850		SUB= 85463
46	107339X		DECAL HYT
47	3146R		RETAINER.SPRING
48	106381X		V-BELT
49	73680800		NUT LTV
51	105435X		RELEASE PIN GT
52	3720R		SPRING M
53	12000039		KLIP RING
54	19171612		WASHER GT
55	105440X		CLEVIS PIN GT
56	105458X		BRACKET T
57	109773X		BRACKET T
58	109775X		BRACKET T
59	105459X		SUB= 105457X
60	73680500		SUB= 73690500
61	109776X		PIVOT PIN T
62	19111016		WASHER
63	109785X		DEFLECTOR SHIELD

Ref #	Part Number	Qty	Description
64	106734X		SUB= 123713X
65	109743X		SUB= 137607
66	106735X		ROD-HINGE T
68	5846R		SUB= 110452X
69	3713J		DECAL INSTRUCTION CAUTION
70	106975X		DECAL - SAFETY STANDARD
71	73220800		NUT
73	19171512		WASHER
75	109819X		NLA
76	110884X		BELT-V.93.5.MWR
77	19151610		WASHER T
78	105185X		DECAL-INST YT
79	10030600		SUB= 10040600
80	109729X		ROLLER T
83	4921H		SPRING.RETAINER
84	19151616		SUB= 19171616
85	120135X		SPACER T
86	19131416		WASHER

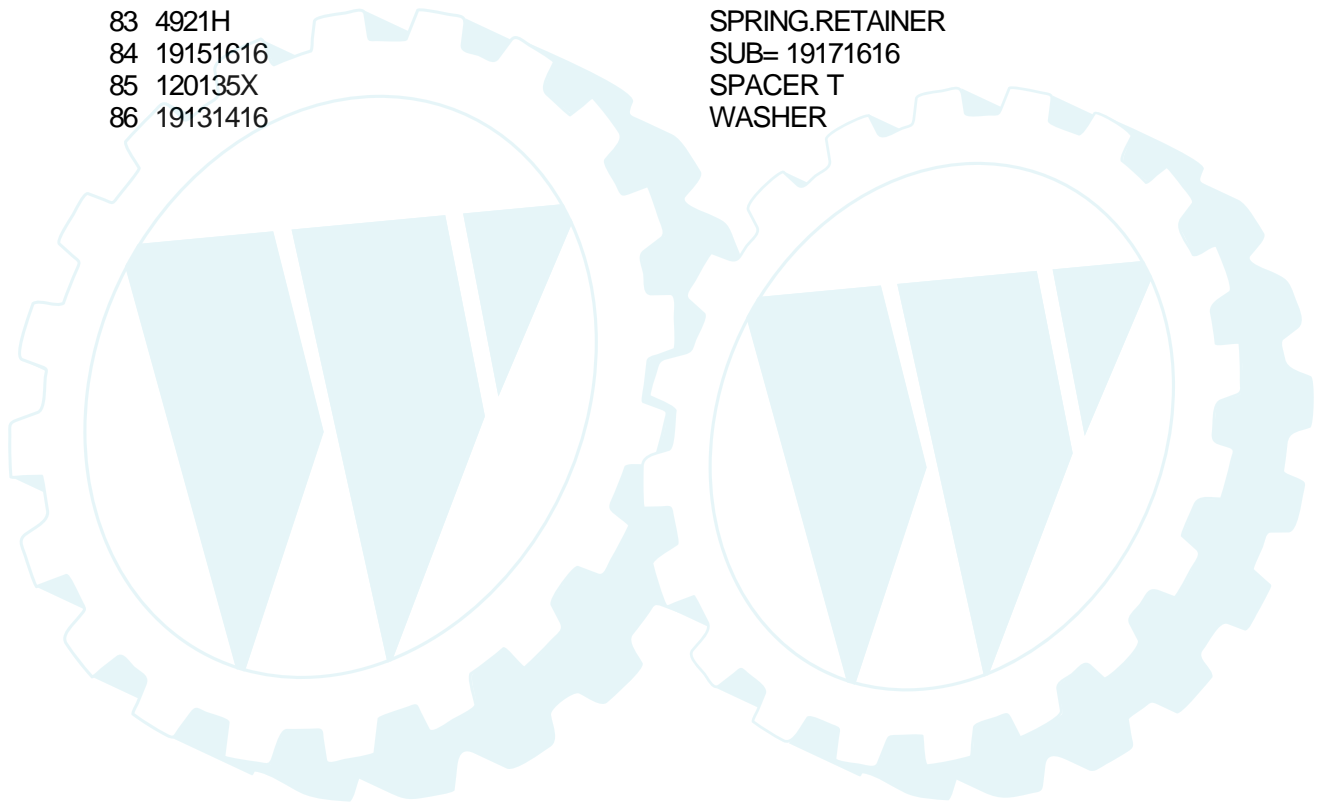

ROPER GT TRACTOR-MODEL NUMBERS GT180ER AND GT180ET

MOWER LIFT

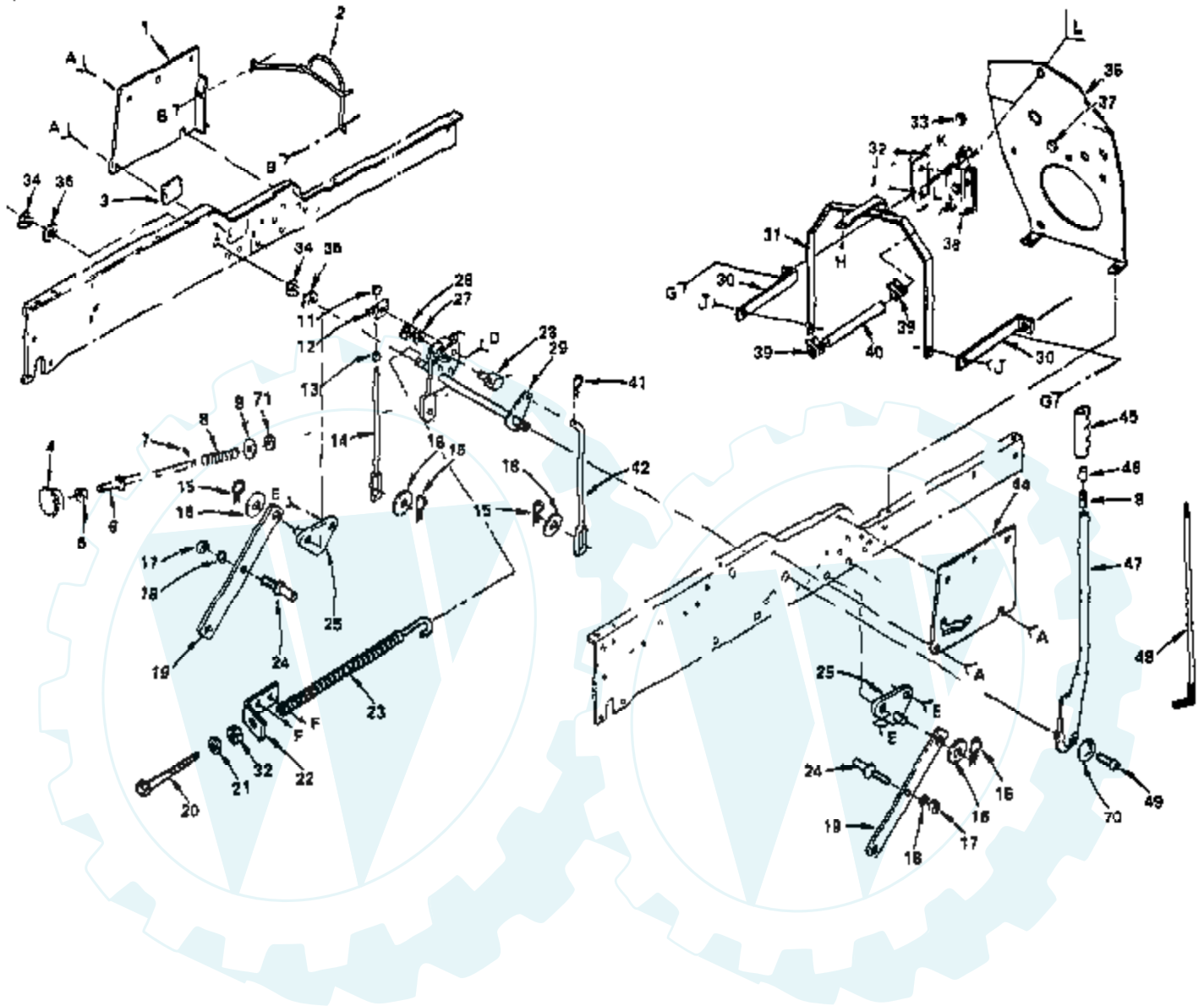

Ref #	Part Number	Qty	Description
1	121044X		SUB= 532121046
2	110908X		SUB= 126651X
3	105505X		SUB= 121794X
4	100734K		SUB= 138057
5	73350600		NUT
6	110811X		ROD ADJ. T
7	76020308		SUB= 3145
8	2876H		SPRING T
9	19131016		WASHER
11	73800600		NUT
12	7594J		BRACKET T
13	73220600		NUT.HEX.3/8-16UNC
14	7596J		LINK-LIFT MOW T
15	9135R		SPRING H
16	19171713		SUB= 146537
17	73220800		NUT
18	10040800		LOCKWASHER
19	105429X		SUSPENSION ARM GT
20	5328J		BOLT-ADJ SPRING T
21	19131316		WASHER
22	5329J		SUB= 143363
23	674A247		SUB= 918674A247
24	105413X		PIVOT STUD GT
25	105501X		SUSP BRACKET T
26	12000037		KLIP RING
27	19151216		WASHER
28	110810X		TRUNION LT
29	120137X		SUB= 145542
30	104649X		BRKT-SHIELD, HEAT, SIDE
31	106872X		SUB= 532128141
32	105040X		BRACKET GT
33	9151R		SNAP BUSHING T
34	12000022		E-RING
35	110948X		HEAT SHIELD T
36	19292016		WASHER
37	106351X		PLUG GT
38	105041X		SUB= 129979
39	6999R		SUB= 123487X
40	3008J		SUB= 7833R
41	4939M		SUB= 85902
42	105503X		LIFT LINK RH T
44	121043X		SUB= 532121045
45	109413X		GRIP
46	105723X		SUB= 125925X
47	121002X		SUB= 123096X
48	121006X		LEVER ROD LT
49	74780624		"BOLT,HEX"
70	10040600		LOCKWASHER
71	110807X		NUT T

ROPER GT TRACTOR--MODEL NUMBERS GT180ER AND GT180ET

SCHEMATIC

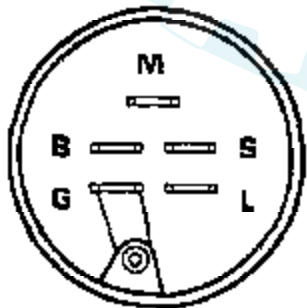
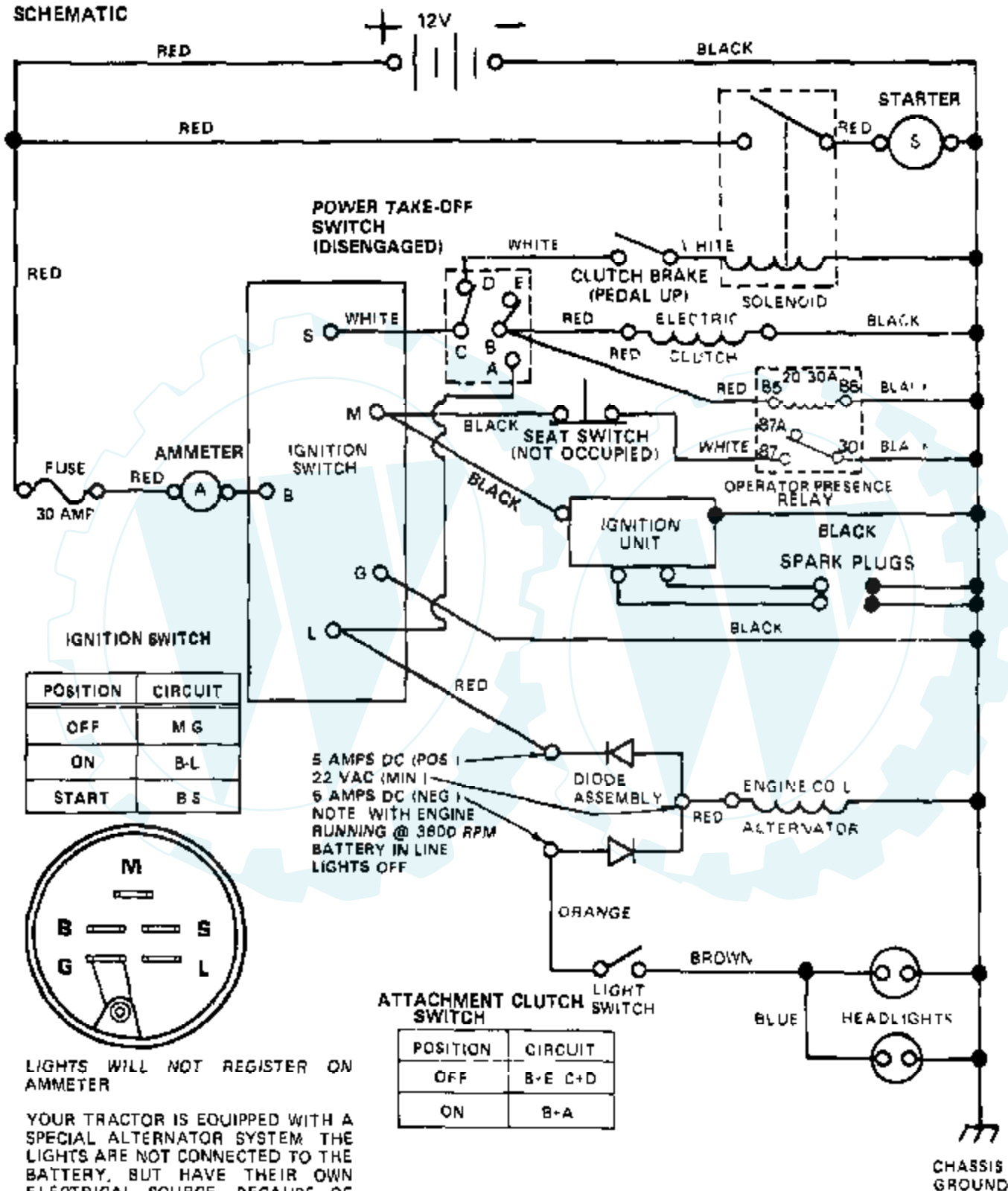

LIGHTS WILL NOT REGISTER ON AMMETER

YOUR TRACTOR IS EQUIPPED WITH A SPECIAL ALTERNATOR SYSTEM THE LIGHTS ARE NOT CONNECTED TO THE BATTERY, BUT HAVE THEIR OWN ELECTRICAL SOURCE BECAUSE OF THIS, THE BRIGHTNESS OF THE LIGHTS WILL CHANGE WITH THE ENGINE SPEED AT IDLE SPEED THE LIGHTS WILL DIM AS THE ENGINE IS SPEEDED UP, THE LIGHTS WILL BECOME THEIR BRIGHTEST

WIRING INSULATED CLIPS

NOTE IF WIRING INSULATED CLIPS WERE REMOVED FOR SERVICING OF UNIT, THEY SHOULD BE REPLACED TO PROPERLY SECURE YOUR WIRING

Ref #	Part Number	Qty	Description
1	104590X		DECAL - STEERING WHEEL
2	100710L		INSERT-WHEEL LT
3	74780616		BOLT
4	10040600		LOCKWASHER
5	19133808		WASHER T
6	100713N		SUB= 150547
7	100711L		ADAPTER LT
8	106943X		SPACER LT
9	108540X		TUBE
10	9038R		"T, BEARING"
11	101274N		SUPPORT ASSY T
12	73680800		NUT LTV
13	19172610		WASHER GT
14	104239X		"FLANGE GT, BEAR."
15	12000034		KLIP RING
16	6266H		WASHER .T
17	5213J		FRAME BRACKET GT
18	102439X		SUB= 144668
19	73610600		SUB= 7810H
20	120424X		SECTOR T
21	74780880		BOLT T
22	104591X		SHAFT STEERING GT
23	110497X		LINK.DRAG.T
24	106046X		SPINDLE ASSY T
25	74520632		BOLT, HEX 3/8 - 16 X 2
26	109848X		SUB= 109849X
27	9040H		"FLANGE, BEARING"
28	106228X		SUB= 106228X417
29	3938R		SUB= 122075X
29A	8134H		TUBE.16X6.5/7.5-8
30	12000029		RING
31	104757X		HUB CAP
32	19252016		SUB= 121749X
33	59192		VALVE CAP
34	65139		VALVE STEM LT
35	278H		FITTING LT
36	106045X		SPINDLE RH T
38	108137X		"T, BELLCRANK"
39	74781044		BOLT
40	1309H		BRNG. T
41	6855M		ZERK M
42	73221000		NUT X
43	10041000		WASHER
44	5298J		SUB= 136518
45	674A243		AXLE ASSEMBLY
46	5292J		SUB= 140342
48	5284J		AXLE BRACKET T
49	19292016		WASHER
50	677A451		IDLER-INSIDE T
51	19133808		WASHER T
52	110946X		STOP T
53	108253X		SUB= 120542X
54	7190X		SPRING
55	108367X		DECAL T
56	8922R		SUB= 109851X
57	73700600		NUT
58	7919J		SUB= 121159X
59	73360600		NUT

Ref #	Part Number	Qty	Description
60	8921R		SUB= 109850X
62	73680600		SUB= 73690600
73	19252616		SUB= 121748X
74	74760632		SUB= 74930632
76	120195X		SUB= 121177X
78	120200X		NYLINER T
79	120199X		TUBE T
80	120800X		SUB= 120448X



ROPER GT TRACTOR—MODEL NUMBERS GT180ER AND GT180ET

TRANSAXLE

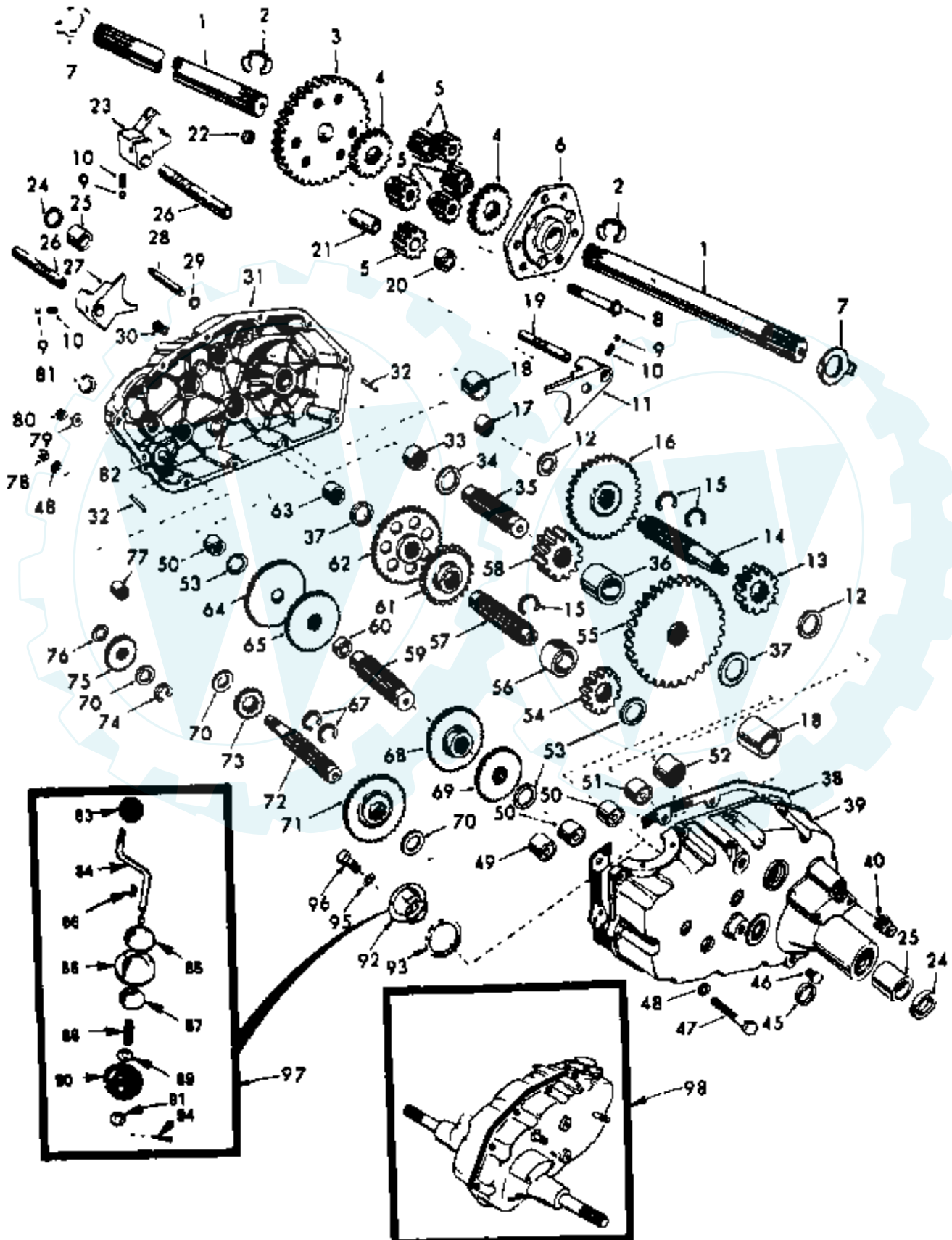

Ref #	Part Number	Qty	Description
1	4197R		SHAFT.AXLE.T
2	5845R		SUB= 12000034
3	4199R		FINAL GEAR T
4	4216R		DIFF GEAR T
5	4215R		DIFF PINION T
6	4217R		DIFF CARRIER T
7	6256H		WASHER T
8	74020652		BOLT
9	7392M		SUB= 100482K
10	6272H		SUB= 145359
11	4985R		SHIFT FORK T
12	6266H		WASHER .T
13	4212R		RED PINION T
14	4196R		GEAR SHAFT T
15	6276H		SNAP RING T
16	633A63		GEAR T
17	8118M		"T, BEARING"
18	8740H1		BEARING
19	6217H		SUB= 122238X
20	4218R		SPACER T
21	6252H1		PINION RS
22	7810H		GRIPCO NUT
23	4986R		SHIFT FORK T
24	7393R		OIL SEAL STD
25	992R1		BRNG. T
26	6216H		SHAFT T
27	6262H		FORK T
28	101416X		SHIFT SHAFT GTV
29	6269H		SEAL T
30	5855H		VALVE M
31	105406X		SUB= 122162X
32	6277H		PIN T
33	4225R		NEEDLE BRNG T
34	7396H		RACE T
35	4198R		GEAR SHAFT T
36	4200R		SUB= 532004200
37	7395H		RACE T
38	6275H		SUB= 121878X
39	105402X		SUB= 122163X
40	13060400		SUB= 13320400
45	6271H		SEAL T
46	13060200		SUB= 13020200
47	74780524		HEX BOLT
48	10140500		SUB= 10040500
49	4895H		"TI, BEARING"
50	4222R		NEEDLE BRNG T
51	1529R		NEEDLE BRNG T
52	8119M		"STD, BEARING"
53	4220R		BRNG RACE
54	4209R		RED PINION T
55	4213R		RED GEAR T
56	4442R		PINION SPACER T
57	4195R		GEAR SHAFT T
58	4214R		FINAL PINION T
59	4194R		GEAR SHAFT T
60	7528R		SPACER T
61	4208R		RED PINION T
62	4207R		RED GEAR T

Ref #	Part Number	Qty	Description
63	7398H		RACE T
64	4203R		LOW SPEED GEA T
65	4204R		REVERSE GEAR T
66	2898J		KEY T
67	4926H		RING STD
68	4205R		INTERMED GEAR T
69	4206R		SUB= 532004206
70	1370H		"T, BEARING"
71	633A69		CLUSTER GEAR T
72	208J		INPUT SHAFT T
73	4201R		LO SPEED PINION T
74	12000002		SUB= 2225J
75	1153R		IDLER GEAR T
76	7392H		WASHER T
77	3990H		BRNG T
78	73220500		NUT.HEX.5/16-18
79	1167R		WASHER T
80	73360700		NUT
81	6270H		SEAL STD
82	7384H		SHAFT T
83	100196K		SUB= 106932X
84	5384J		GEAR SHIFT LVR T
85	2978J		CAP T
86	633A85		COVER AND PIN T
87	8739H1		GUIDE BALL T
88	4924H		SPRING TI
89	19151516		WASHER
90	110542X		SEAL T
91	19181511		WASHER
92	75J		GEAR SHIFT GA T
93	6274H		GASKET T
94	76020412		COTTER PIN
95	10040500		LOCKWASHER
96	74760514		BOLT
97	633A109		GEAR SHFT LVR T
98	105474X		TRANSAXLE GTV