

ROPER GT TRACTOR--MODEL NUMBERS GT180BR AND GT180BT

ELECTRICAL

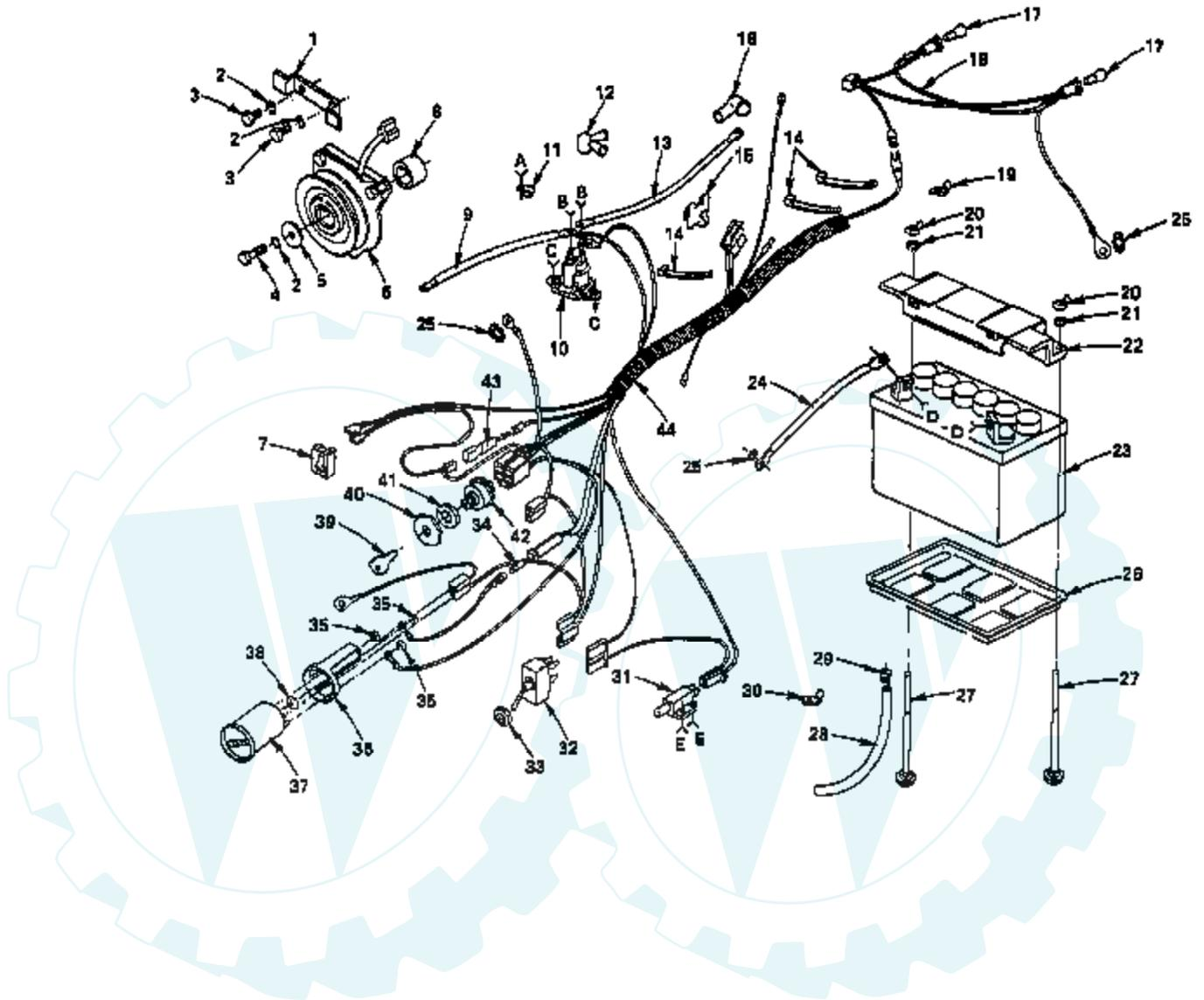

Ref #	Part Number	Qty	Description
1	108170X		STOP CLUTCH T
2	10040600		LOCKWASHER
3	74780612		BOLT
4	74610628		BOLT
5	19132203		WASHER GT
6	106316X		SUB= 109550X
7	105381X		SUB= 110712X
8	106367X		SPACER-CLUTCH GT
9	4206J		CABLE-BATTERY T
10	2008J		SUB= 146154
11	4171R		CLIP T
12	51J		TERM COVER DUAL
13	5115J		SUB= 5114J
14	7192J		WIRE TIE
15	105035X		CLIP-HARNESS
16	719J		SUB= 154336
17	4152J		HEADLAMP BULB
18	105387X		NLA
19	105034X		CLIP GT
20	73490400		SUB= 146525
21	19091016		WASHER
22	102476X		SUB= 150109
23	9138R		SUB= 123899X
24	4607J		SUB= 4207J
25	11050600		LOCKWASHER
26	7603J		"TRAY T, BATTERY"
27	72240460		BOLT
28	100541K		SUB= 7697J
29	6999R		SUB= 123487X
30	100207K		CLIP GTV
31	104445X		SWITCH-INTER. GT
32	4021J		SWITCH.PTO.T
33	4022J		HEX NUT T
34	6347R		FUSE-30 AMP
35	73951000		"NUT,KEPS"
36	106336X		NLA
37	104566X		METER - HOUR, AMPS
38	106312X		WASHER
39	105613X		SUB= STD365410
40	3258J		CONDUIT NUT L
41	11151000		LOCKWASHER
42	4406R		SUB= STD365402
43	106315X		SUB= 135665
44	106873X		HARNESS, IGNITION
	101539X		SHEET INSTR LT
	106803X		OWNER'S MANUAL

ROPER GT TRACTOR--MODEL NUMBERS GT180BR AND GT180BT

FRAME, FENDER AND DRAWBAR

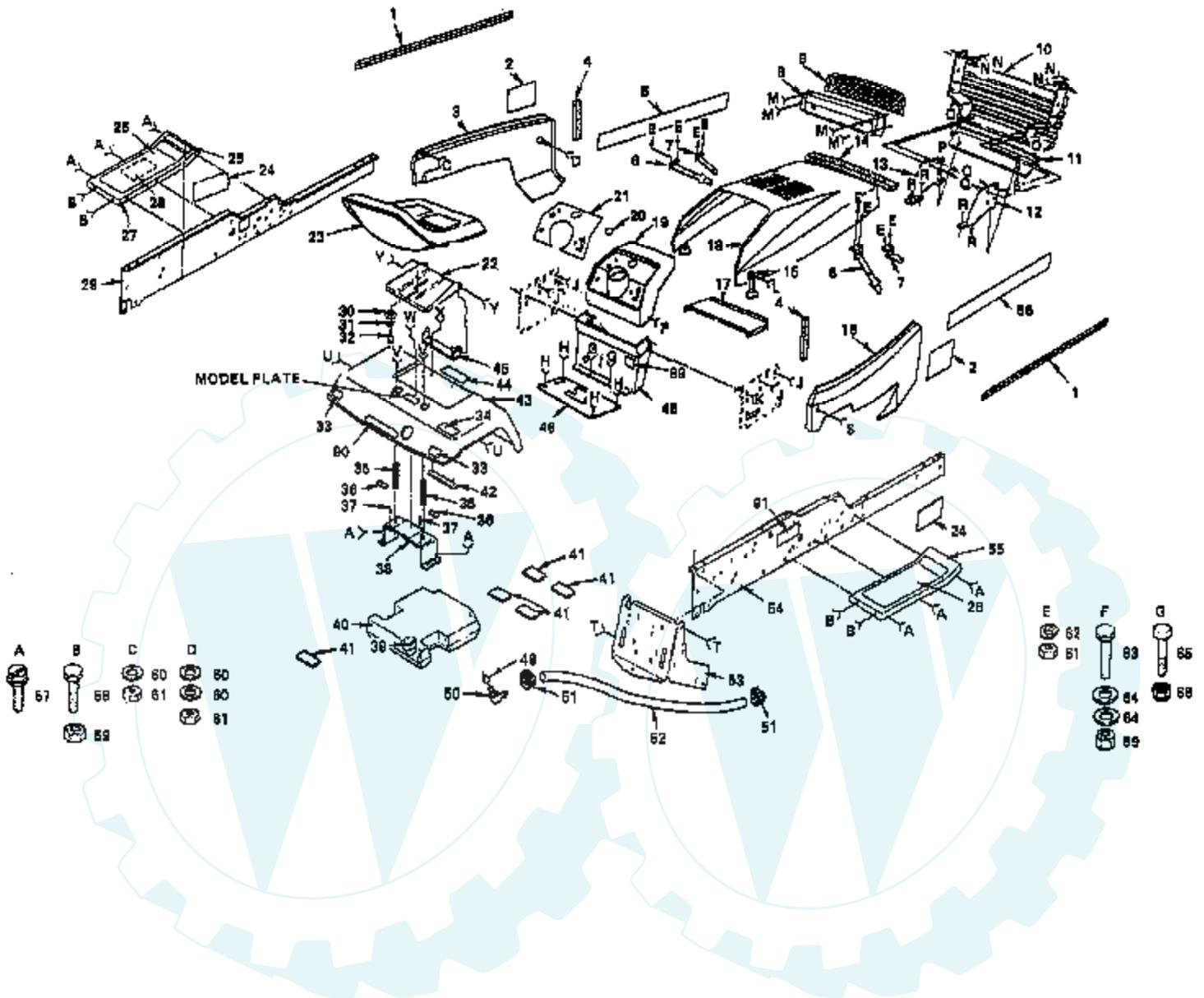

Ref #	Part Number	Qty	Description
1	104646X		NLA
2	104639X		NLA
3	108372X358		SUB= 150302X505
4	105036X		FOAM STRIP HYT
5	104643X		NLA
6	106784X		SUB= 155013
7	104618X		SUB= 155013
8	104613X		SUB= 147717
9	106395X		LENS LT
10	104628X		GRILL GT
11	104634X358		SUB= 105419X388
12	105288X		SUPPORT-GRILL
13	105287X		SUPPORT-GRILL
14	105037X		FOAM-STRIP LT
15	100225L		SUB= 109808X
16	108371X358		SUB= 140679X505
17	7985J		SUB= 140229
18	108370X358		SUB= 150301X505
19	106796X		DASHBOARD T
20	8022J		PLUG-DASH T
21	106797X		DECAL-DASHBOARD
21	108697X		DECAL-DASHBOARD
22	105516X		SUB= 155925
23	104602X		SUB= 140121
24	104640X		NLA
25	4900J		DECAL T
26	108256X		PAD FOOTREST T
27	105465X358		SUB= 145244X428
28	106868X		DECAL T
29	105504X		SUB= 151630
30	19171912		WASHER
31	10110800		SUB= 10040800
32	74760816		SUB= 74780816
33	106202X		REFLECTOR-TAIL YT
34	7178J		DECAL-CAUTION
34	101893X		NLA
35	105512X		SPRING LT
36	105514X		"CLAMP, SPRING LT"
37	105531X		NUT-PUSH YT
38	105509X		SUB= 137113
39	105965X		SUB= 158990
40	106020X		SUB= 151346
41	106082X		PAD-SPACER LT
42	105511X		SUB= 140675
43	105507X358		SUB= 109593X367
44	106974X		SUB= 133796
44	108658X		SUB= 120822X
45	105513X		SUB= 140551
46	101365X		SUB= 106042X012
46	108696X		SUB= 106042X012
48	104608X		DASH ASSEMBLY
49	3645J		BUSHING OUTLET T
50	8710J		FUEL TANK STEM GT
51	6999R		SUB= 123487X
52	5277J		SUB= 8543R
53	7982J		SUB= 140506
54	105506X		SUB= 150383
55	105464X358		SUB= 145243X505

Ref #	Part Number	Qty	Description
56	104644X		NLA
57	17490612		SCREW
58	74760612		SUB= 74780612
59	73680600		SUB= 73690600
60	19091216		WASHER PM
61	73220400		SUB= 50675
62	10090400		SUB= 10040400
63	74760616		BOLT
64	19131316		WASHER
65	74040512		BOLT
66	73680500		SUB= 73690500
89	8497J		DECAL, INSTRUCTION
89	101895X		NLA
90	104810X		NLA
91	109044X		NLA

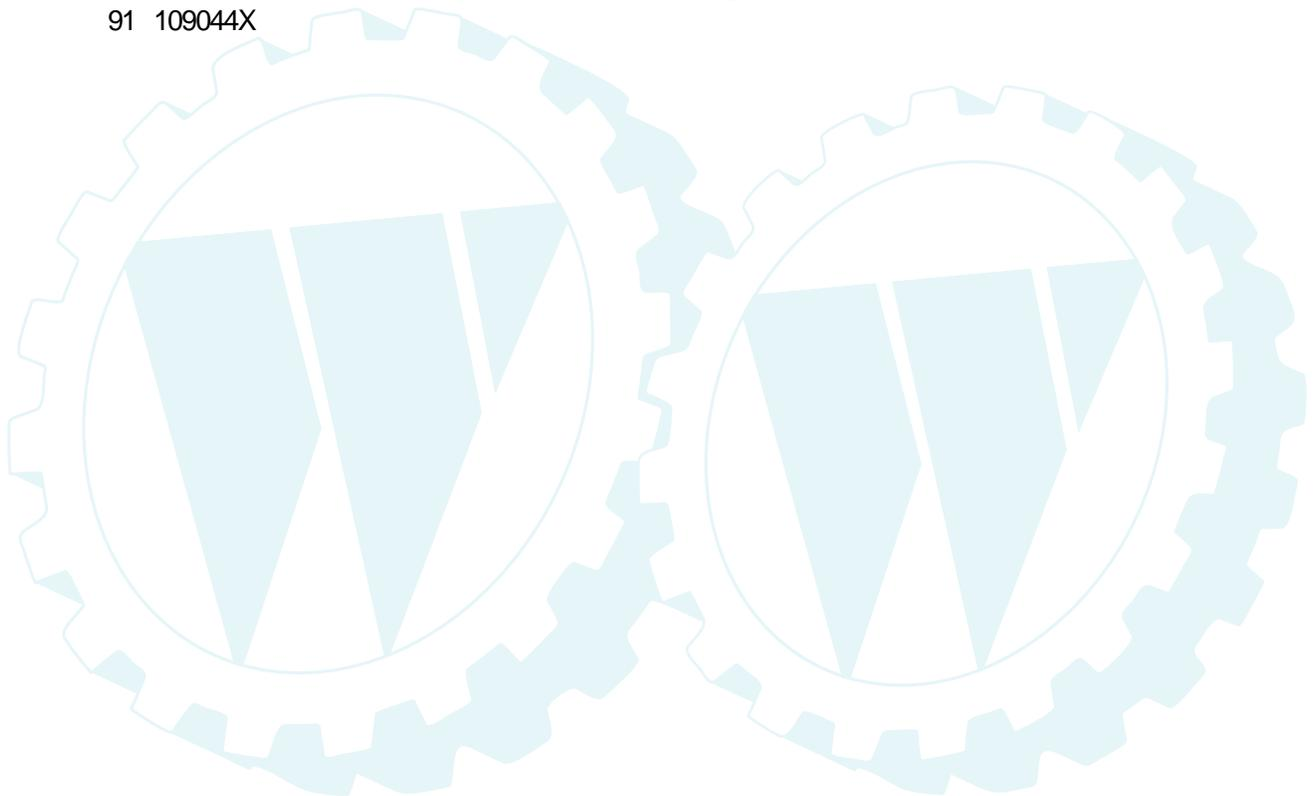

ROPER GT TRACTOR--MODEL NUMBERS GT180BR AND GT180BT

GROUND DRIVE

- |                                  |                            |                            |                            |                      |                                  |                       |                       |                 |                        |                        |                       |                       |                              |
|----------------------------------|----------------------------|----------------------------|----------------------------|----------------------|----------------------------------|-----------------------|-----------------------|-----------------|------------------------|------------------------|-----------------------|-----------------------|------------------------------|
| <b>A</b><br>87<br>88<br>88<br>89 | <b>B</b><br>87<br>88<br>89 | <b>C</b><br>90<br>91<br>92 | <b>D</b><br>93<br>94<br>95 | <b>E</b><br>96<br>97 | <b>F</b><br>98<br>99<br>91<br>92 | <b>G</b><br>100<br>45 | <b>H</b><br>101<br>94 | <b>J</b><br>102 | <b>K</b><br>103<br>104 | <b>L</b><br>105<br>106 | <b>M</b><br>107<br>45 | <b>N</b><br>101<br>45 | <b>O</b><br>107<br>108<br>45 |
|----------------------------------|----------------------------|----------------------------|----------------------------|----------------------|----------------------------------|-----------------------|-----------------------|-----------------|------------------------|------------------------|-----------------------|-----------------------|------------------------------|

- |                        |                              |                                    |                        |                 |
|------------------------|------------------------------|------------------------------------|------------------------|-----------------|
| <b>P</b><br>109<br>110 | <b>Q</b><br>107<br>111<br>45 | <b>R</b><br>112<br>17<br>94<br>113 | <b>S</b><br>114<br>115 | <b>T</b><br>116 |
|------------------------|------------------------------|------------------------------------|------------------------|-----------------|

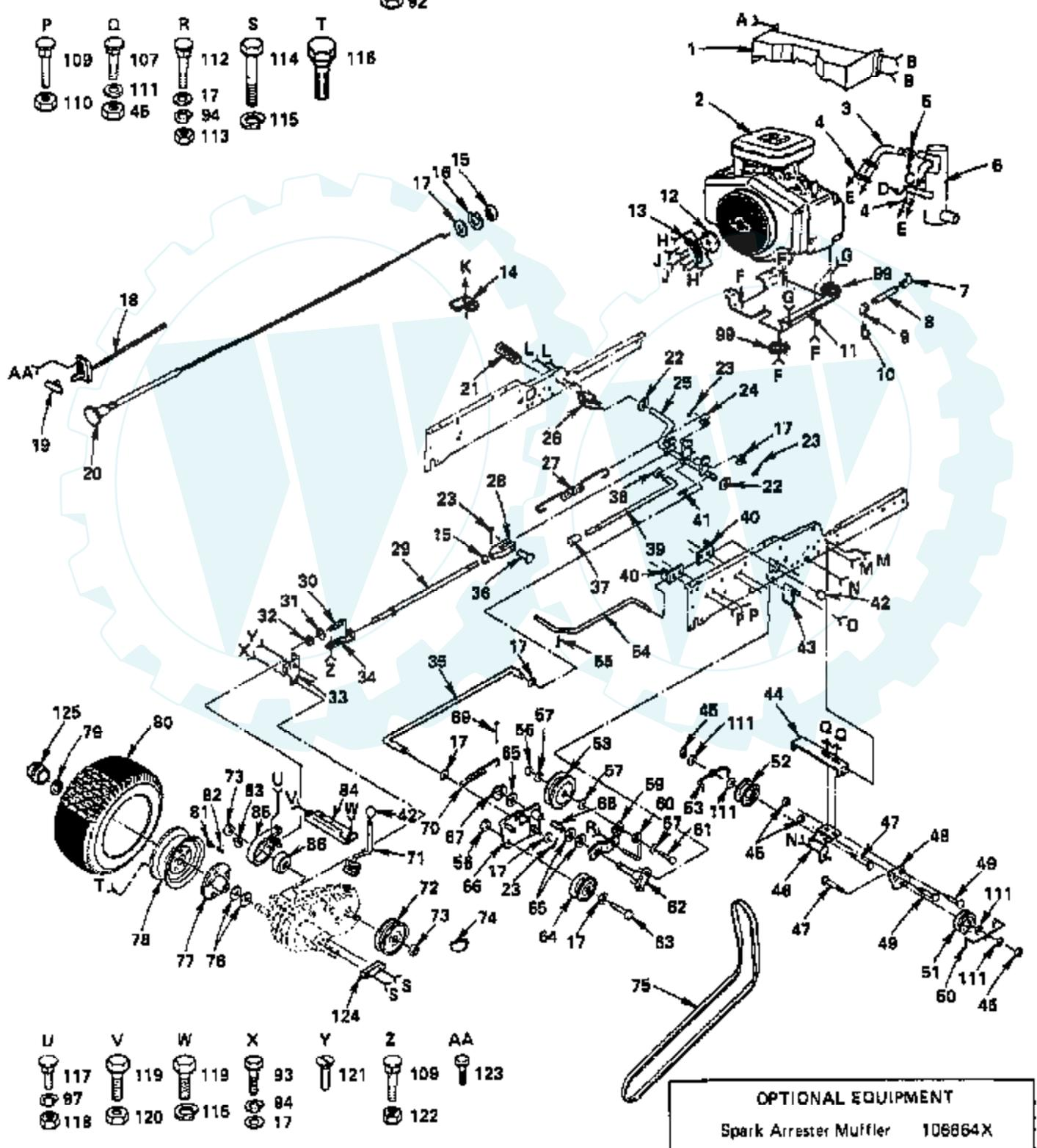

- |                              |                        |                        |                            |                 |                        |                  |
|------------------------------|------------------------|------------------------|----------------------------|-----------------|------------------------|------------------|
| <b>U</b><br>117<br>97<br>118 | <b>V</b><br>119<br>120 | <b>W</b><br>119<br>115 | <b>X</b><br>93<br>84<br>17 | <b>Y</b><br>121 | <b>Z</b><br>109<br>122 | <b>AA</b><br>123 |
|------------------------------|------------------------|------------------------|----------------------------|-----------------|------------------------|------------------|

**OPTIONAL EQUIPMENT**  
Spark Arrester Muffler 106864X

Ref #	Part Number	Qty	Description
1	104993X		BAFFLE ASSY-ENGINE
2	422437		ENGINE
3	100229L		EXHAUST TUBE T
4	8545J		SUB= 272250
5	100000K		CLAMP-TUBE GTV
6	100228N		MUFFLER T
7	13240200		ELBOW
8	13280220		NIPPLE-1/4
9	13200200		NLA
10	13020200		PIPE PLUG
11	5266J		"ENGINE GT, BASE"
12	104577X		ADAPTER T
13	101343L		PULLEY GTV
14	5304J		ACT-SWITCH T
15	73610600		SUB= 7810H
16	11050600		LOCKWASHER
17	19131316		WASHER
18	5693J		THRTL CONTROL T
19	61159		KNOB
20	104596X		SUB= 532132780
21	8883R		PEDAL COVER T
22	19252016		SUB= 121749X
23	76020312		SUB= 3145
24	19111216		WASHER M
25	104375X		SHAFT ASSY GT
26	104601X		BRKT SWITCH GT
27	106021X		EXT SPRING GT
28	100604K		YOKE GTV
29	5308J		BRAKE ROD T
30	7241J		SPRING T
31	19131614		WASHER
32	73530600		SUB= 7810H
33	677A637		BRAKE BRKT ASSY T
34	7229J		GUIDE ROD T
35	101356L		ROD CLUTCH GTV
36	5102J		CLEVIS PIN T
37	71673		PLUNGER CAP T
38	19132012		WASHER
39	8000J		SUB= 136284
40	105598X		ROD BRACKET GT
41	5142H		ROLL PIN STD
42	100196K		SUB= 106932X
43	105500X		BELT RETAINER GT
44	105599X		BRACKET-DRIVE GT
45	73680600		SUB= 73690600
46	106000X		BRKT-V-PULLEY GT
47	72110616		BOLT
48	5255J		BRACKET
49	72140606		BOLT
50	106048X		NLA
51	102403X		IDLER-FLAT T
52	101344L		PULLEY V IDLR GTV
53	106023X		BELT GUARD GT
54	101345M		ROD SHIFT GTV
55	76020616		SUB= 76020624
56	73930600		LOCKNUT
57	19131413		WASHER
58	104360X		SUB= 131494

Ref #	Part Number	Qty	Description
59	101347L		BRACKET GTV
60	105597X		BELT RETAINER GT
61	74760632		SUB= 74930632
62	101358K		BRACKET ASSY GTV
63	74760624		SUB= 74930624
64	8846R		SUB= 110484X
65	207J		WASHER T
66	105592X		CLUTCH BRACKET GT
67	12000039		KLIP RING
68	101350K		"GTV, BEARING"
69	76020816		COTTER PIN
70	101355X		SPRING GTV
71	633A109		GEAR SHFT LVR T
72	101341M		PULLEY GTV
73	9204H		NUT STD
74	9858M1		KEY
75	101342N		BELT-V.93.07
76	7563R		WASHER T
77	634A692		SUB= 149176X431
78	9528R		SUB= 106277X427
79	12000034		KLIP RING
80	4607R		SUB= 122077X
	7154J		TUBE.23X8/10-12
81	59192		VALVE CAP
82	65139		VALVE STEM LT
83	2228M		SUB= 2228M1
84	7952J		SUB= 156404
85	7920J		SUB= 101122M
86	214J		BRAKE DRUM T
87	74780412		SUB= 74780414
88	19091016		WASHER
89	73690400		LOCKNUT
90	72010510		BOLT
91	10040500		LOCKWASHER
92	73220500		NUT.HEX.5/16-18
93	74570412		SCREW GTV
94	10040600		LOCKWASHER
95	19131210		WASHER
96	74570412		SCREW GTV
97	10040400		LOCKWASHER
98	74780520		BOLT
99	11050500		LOCKWASHER.5/16.E
100	74760612		SUB= 74780612
101	74780616		BOLT
102	17190512		SCREW T
103	74321016		SCREW
104	73631000		SUB= 69180
105	74760412		BOLT LT
106	73680400		SUB= 73690400
107	72110608		BOLT D
108	19131312		WASHER
109	72110506		SUB= 72270506
110	73680500		SUB= 73690500
111	19131612		WASHER GT
112	72140608		SUB= 72110608
113	73350600		NUT
114	74780740		BOLT T
115	10040700		LOCKWASHER

Ref #	Part Number	Qty	Description
116	1304H		SUB= 140080
117	72140405		BOLT T
118	73220400		SUB= 50675
119	74760716		BOLT
120	73680700		NUT GTV
121	74370612		SCREW
122	1685H		SUB= 68478
123	17720408		SCREW
124	4186J		SPACER
125	104758X		CAP-HUB GT

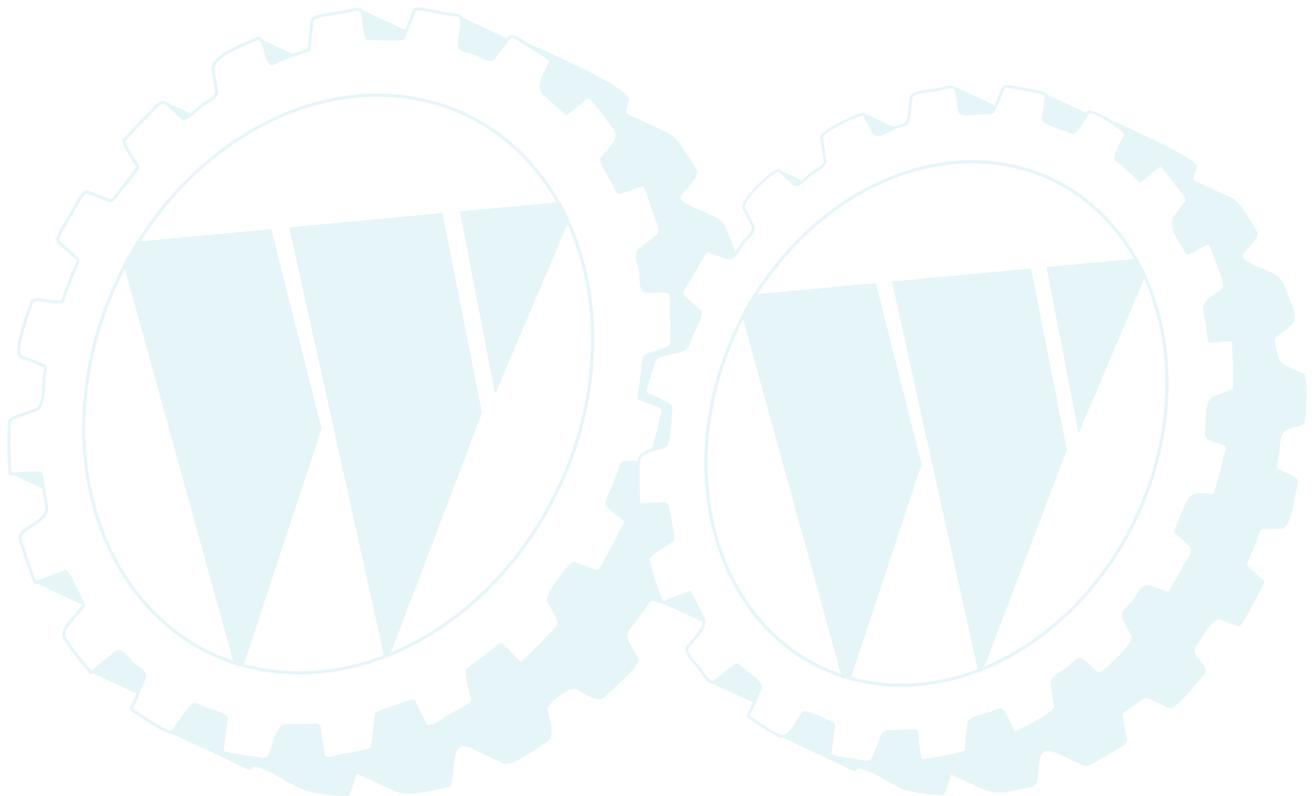

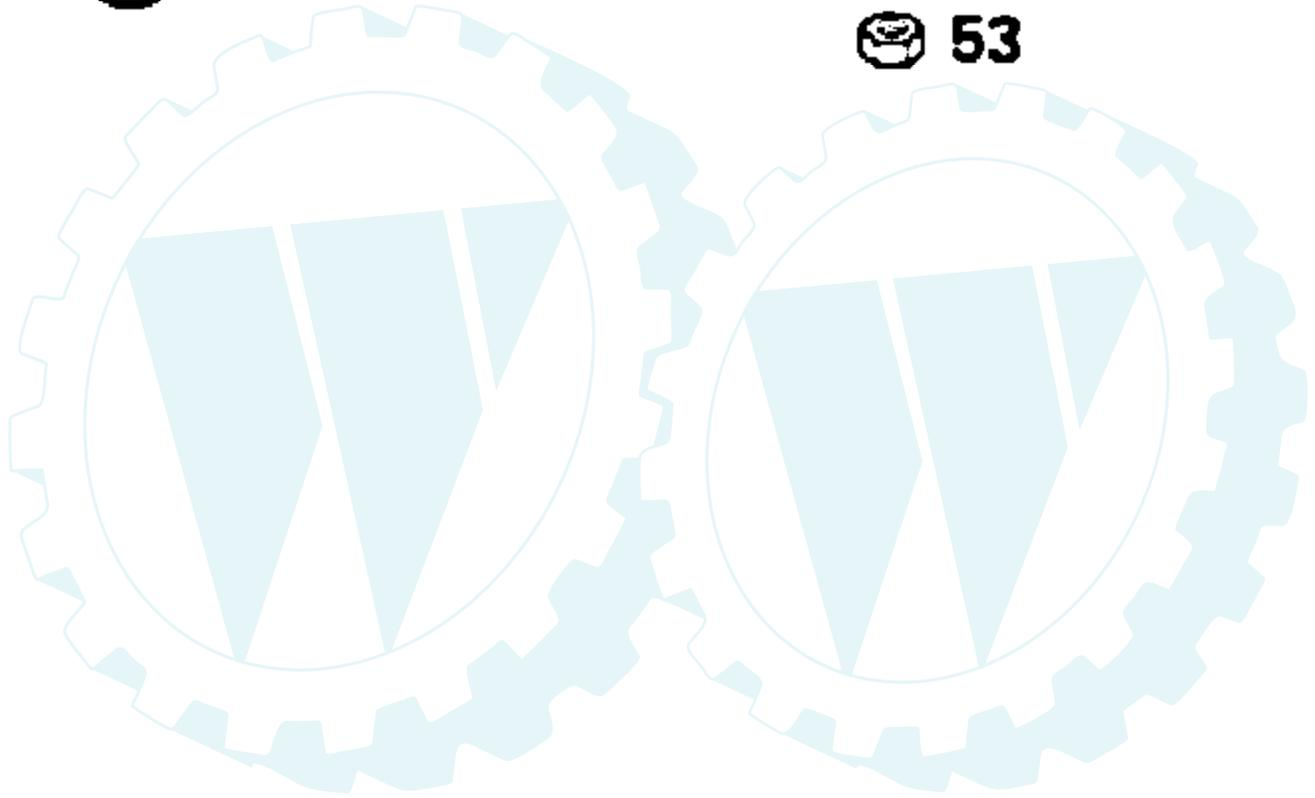
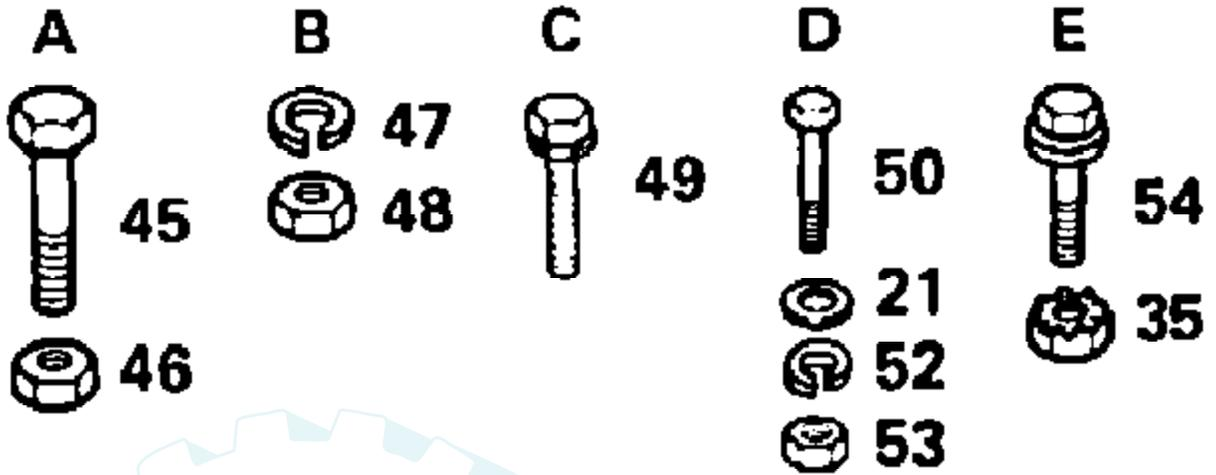

Ref #	Part Number	Qty	Description
21	19091016		WASHER
35	73951000		"NUT,KEPS"
45	74760512		BOLT
46	73680500		SUB= 73690500
47	10090400		SUB= 10040400
48	73350400		NUT
49	17190408		SCREW ST
50	74760412		BOLT LT
52	10040400		LOCKWASHER
53	73220400		SUB= 50675
54	71031008		SCREW
	101539X		SHEET INSTR LT
	106803X		OWNER'S MANUAL

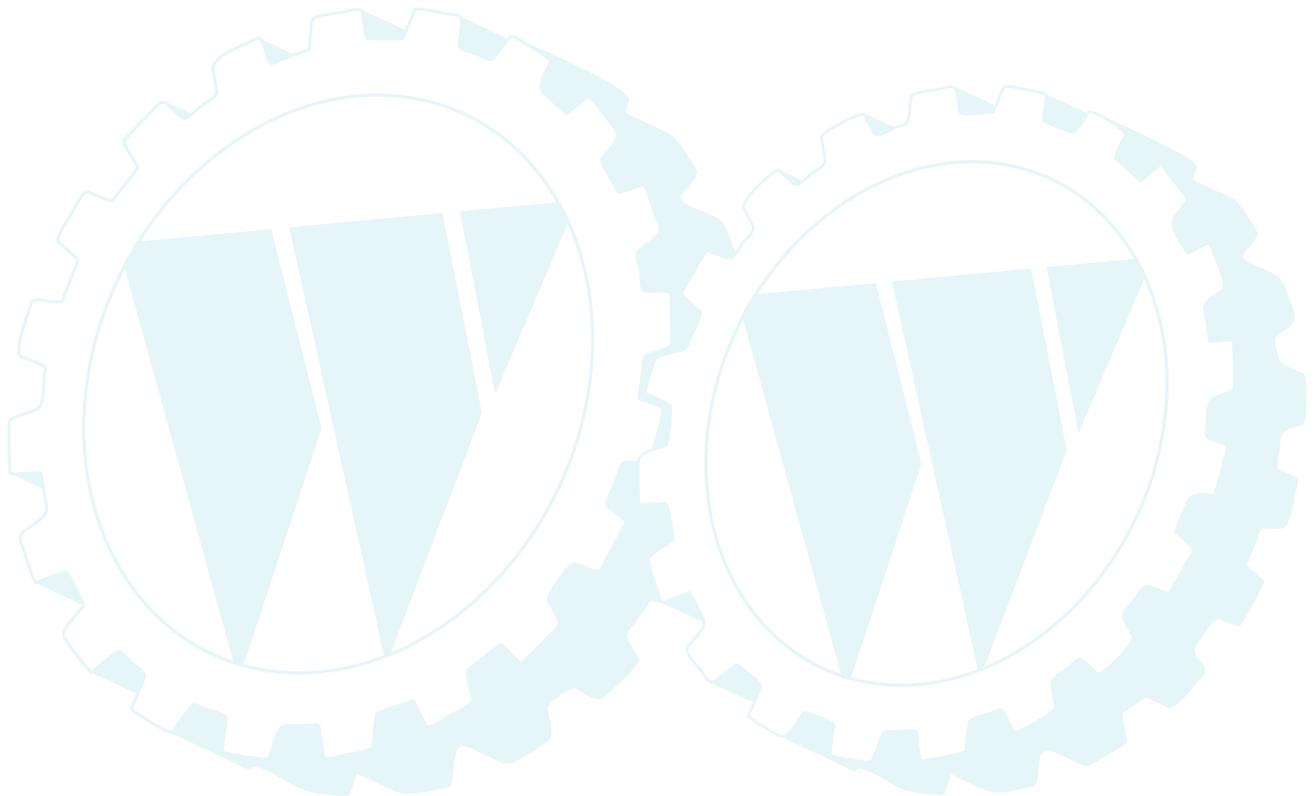

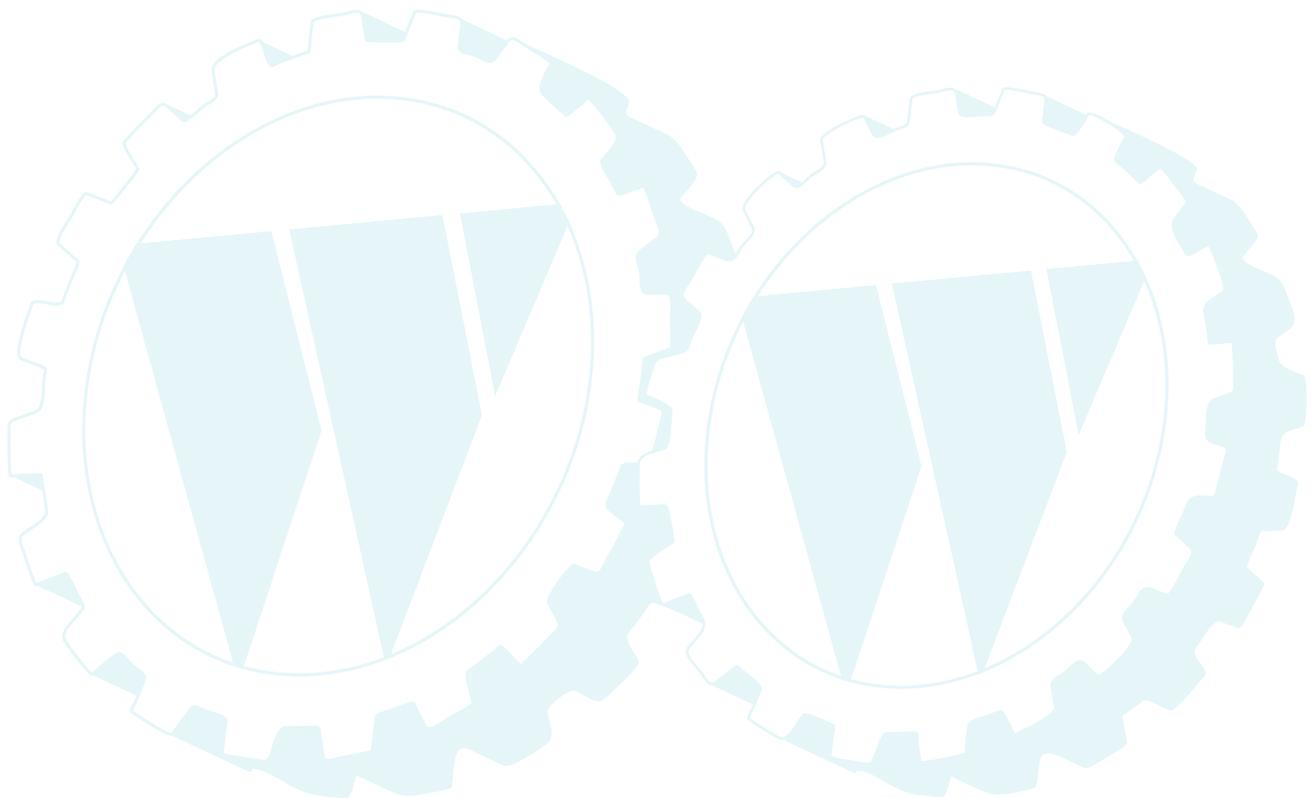
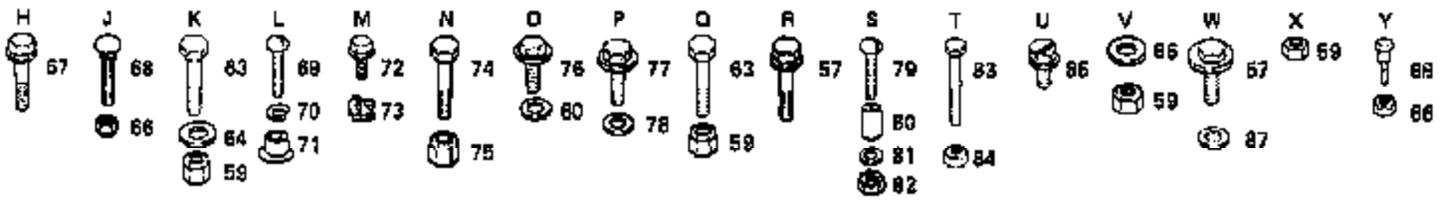

Ref #	Part Number	Qty	Description
57	17490612		SCREW
59	73680600		SUB= 73690600
60	19091216		WASHER PM
63	74760616		BOLT
64	19131316		WASHER
66	73680500		SUB= 73690500
67	17240408		SUB= 17720408
68	72140506		BOLT
69	74191008		SCREW
70	1007100		WASHER LOCK #10
71	2029J		WELDNUT
72	17211010		SCREW LT
73	104755X		""J"" FASTENER LT"
74	7605J		BOLT T
75	73680400		SUB= 73690400
76	17490412		SCREW HEX CRT
77	17490512		SCREW
78	19111216		WASHER M
79	74981020		SCREW
80	7206J		SPACER LT
81	19070818		WASHER
82	73731000		NUT
83	74760716		BOLT
84	73680700		NUT GTV
85	17490608		SCREW LT
86	19132012		WASHER
87	19131416		WASHER
88	105529X		SUB= 139888

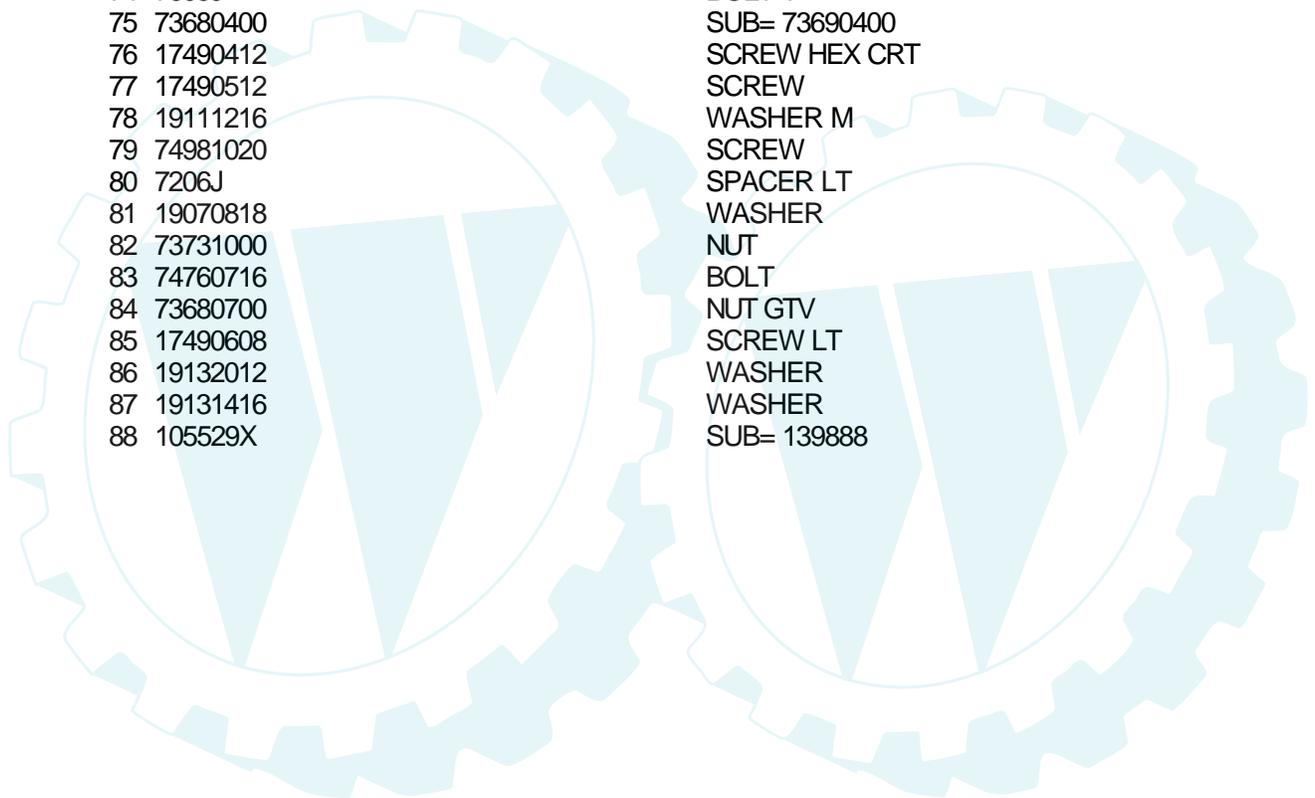

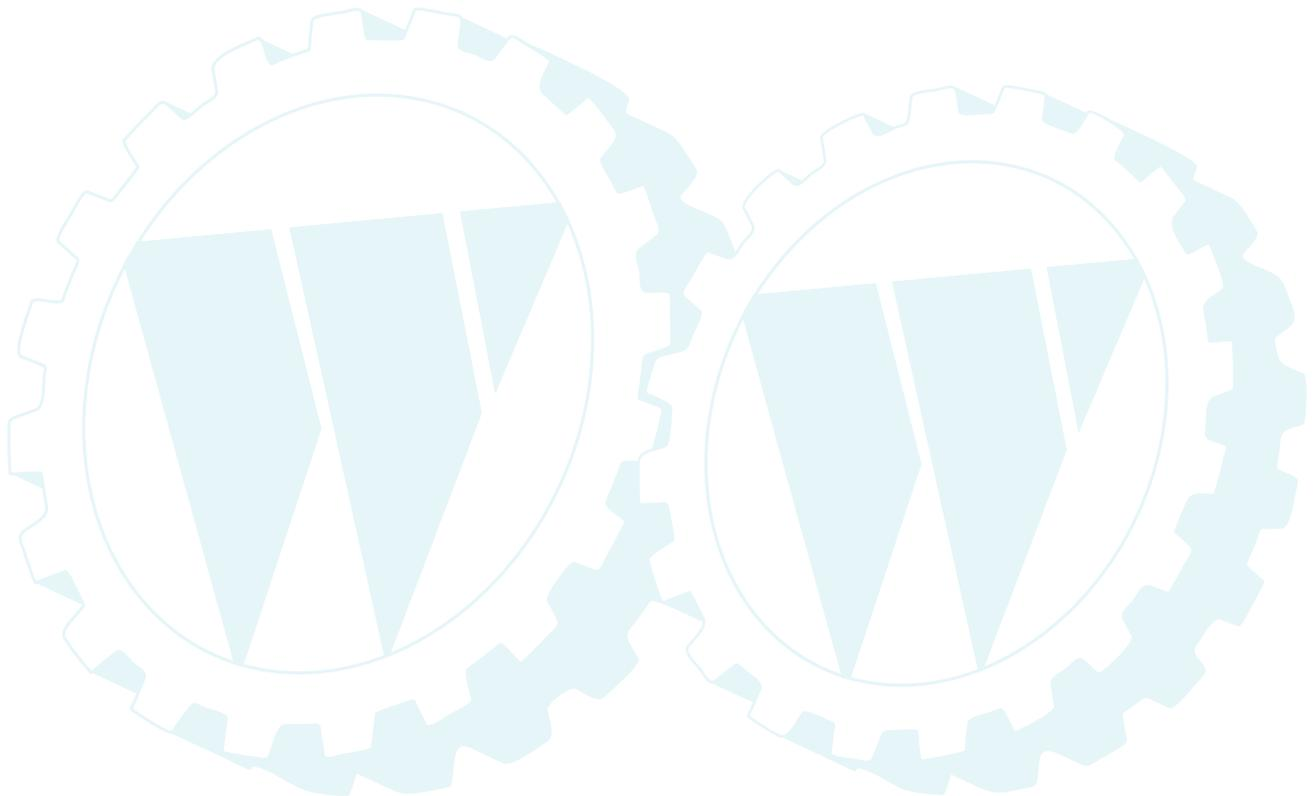
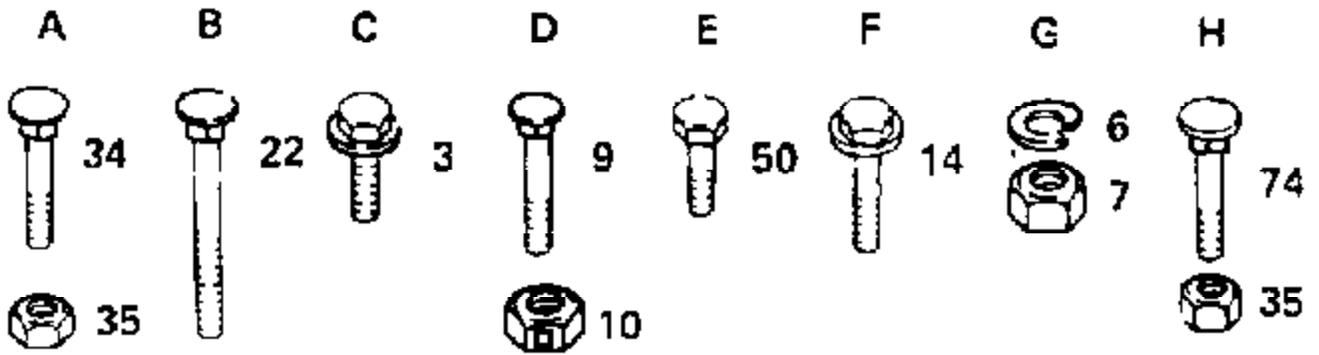

Ref #	Part Number	Qty	Description
3	17490508		SCREW LT
6	10040500		LOCKWASHER
7	73220500		NUT.HEX.5/16-18
9	72140506		BOLT
10	1685H		SUB= 68478
14	17490612		SCREW
22	72110522		BOLT
34	72240606		BOLT
35	73680600		SUB= 73690600
50	74760622		BOLT
74	72240608		BOLT
	200174X		COMPLETE MOWER DECK ASSY

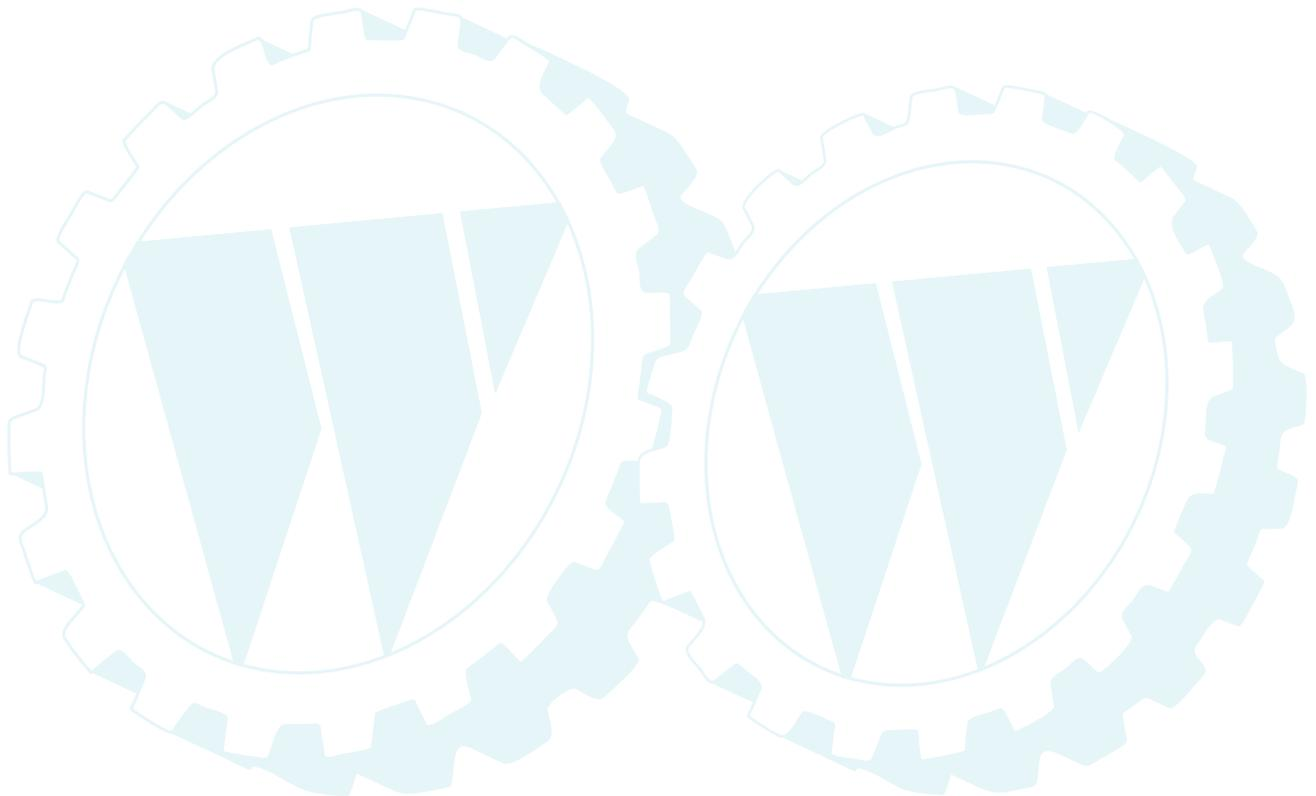

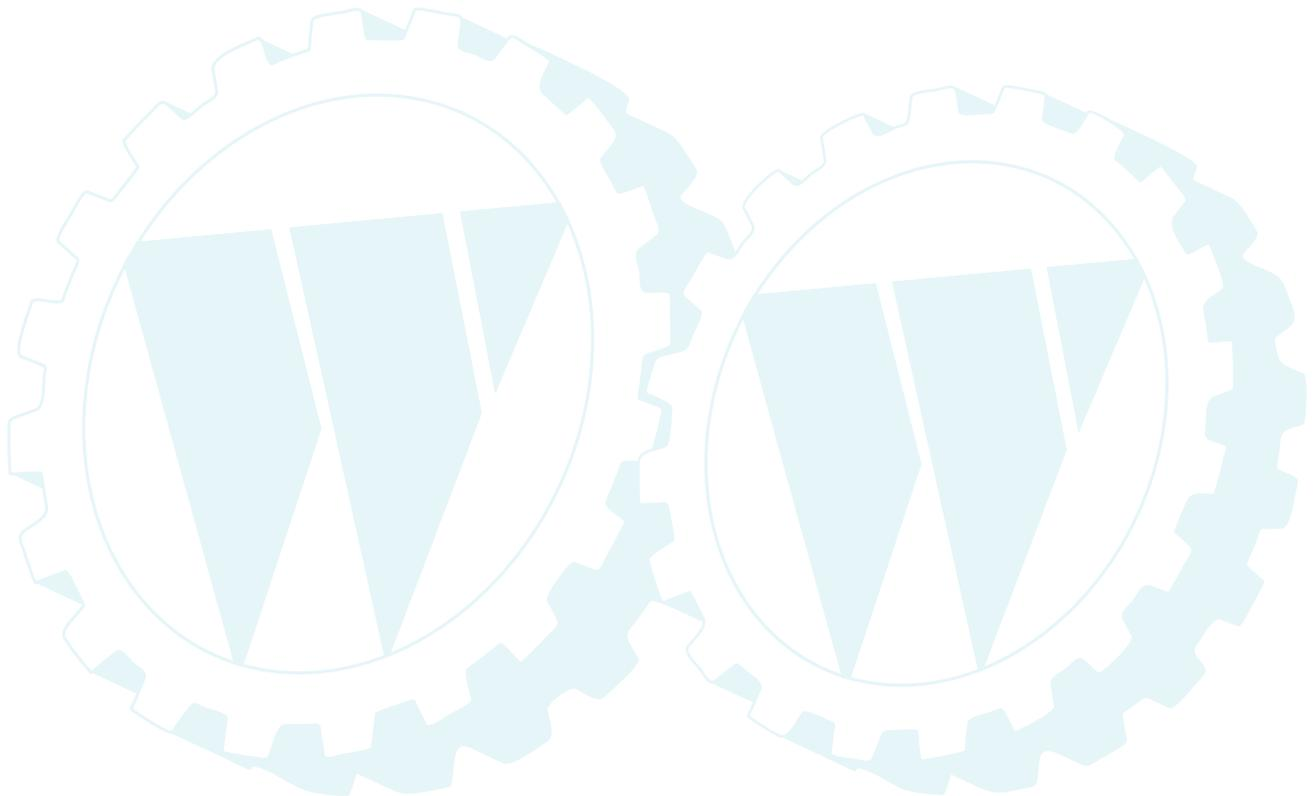
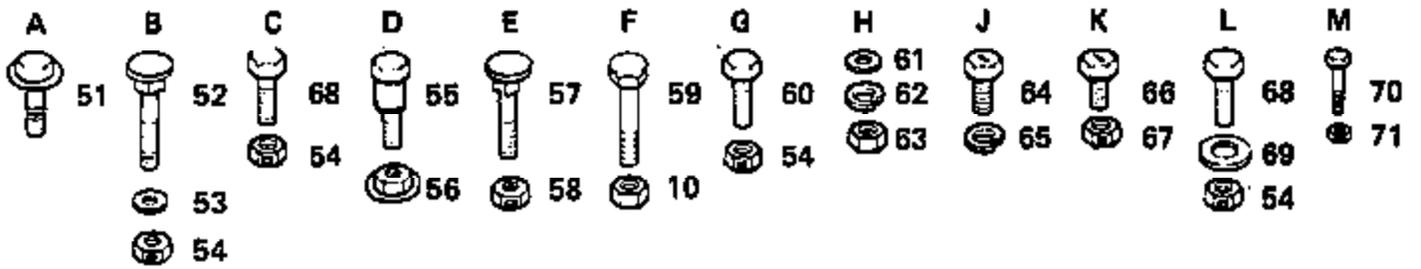

Ref #	Part Number	Qty	Description
10	73680600		SUB= 73690600
51	17490608		SCREW LT
52	72140508		BOLT
53	19111610		WASHER
54	73680500		SUB= 73690500
55	7901J		SHOULDER BOLT T
56	73900400		NUT T
57	72140606		BOLT
58	73930600		LOCKNUT
59	74760616		BOLT
60	74350512		BOLT LT
61	19091216		WASHER PM
62	10090400		SUB= 10040400
63	73220400		SUB= 50675
64	74750806		SCREW GT
65	10070800		NLA
66	74321008		NLA
67	73631000		SUB= 69180
68	74760512		BOLT
69	19111216		WASHER M
70	74780408		BOLT
71	73680400		SUB= 73690400

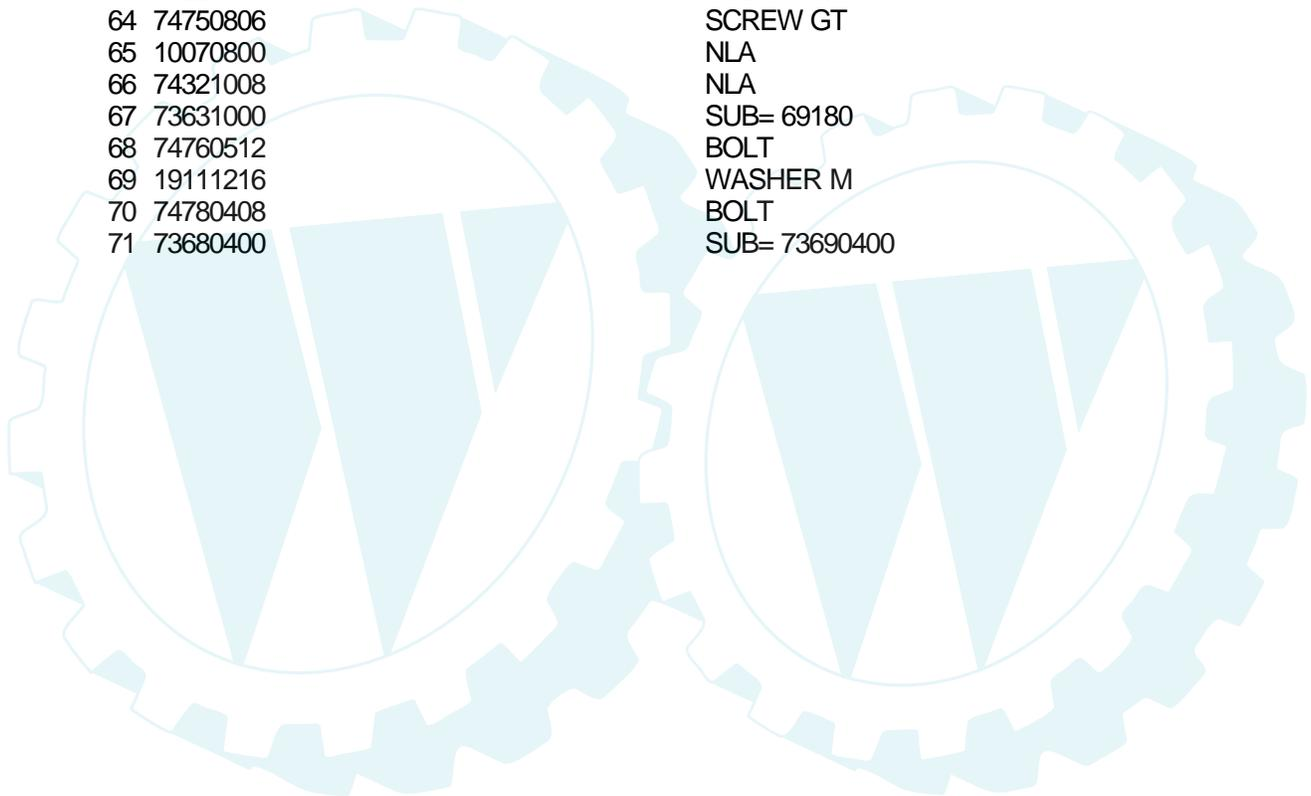

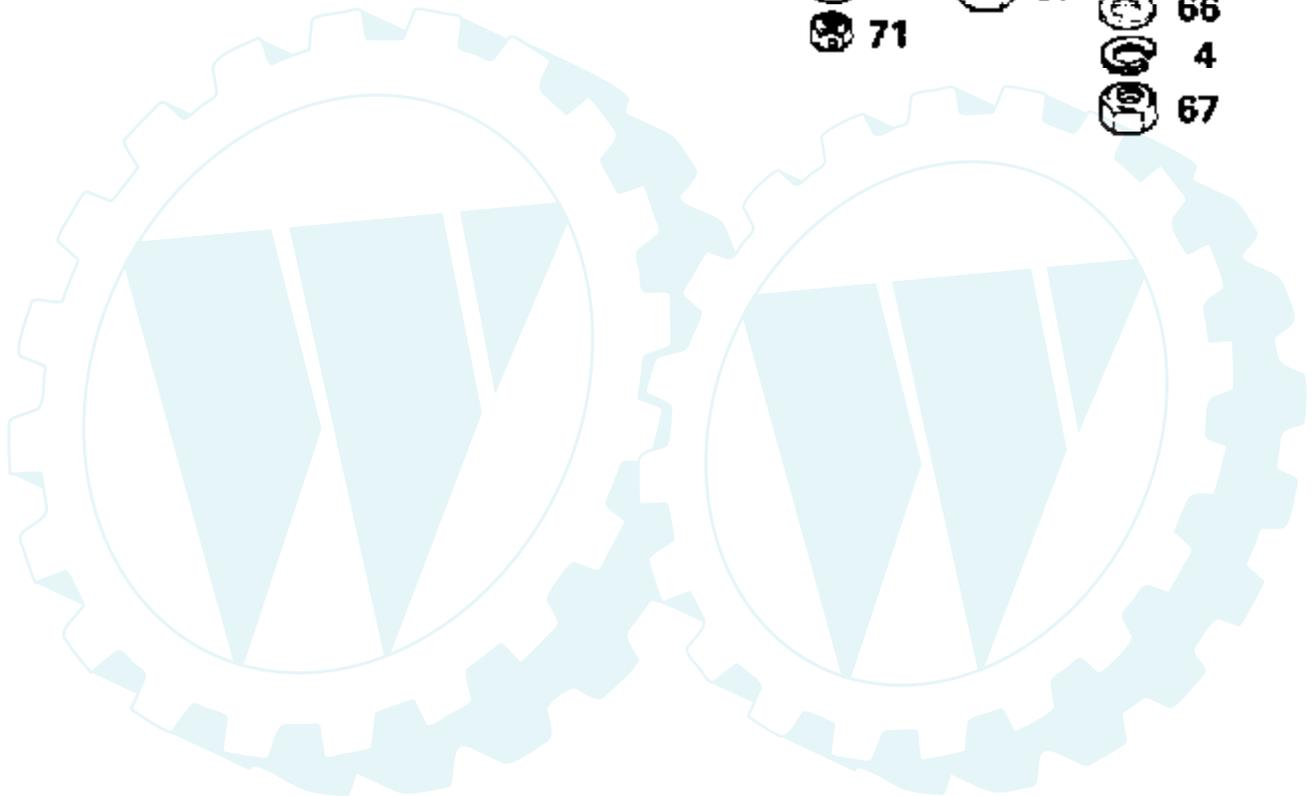
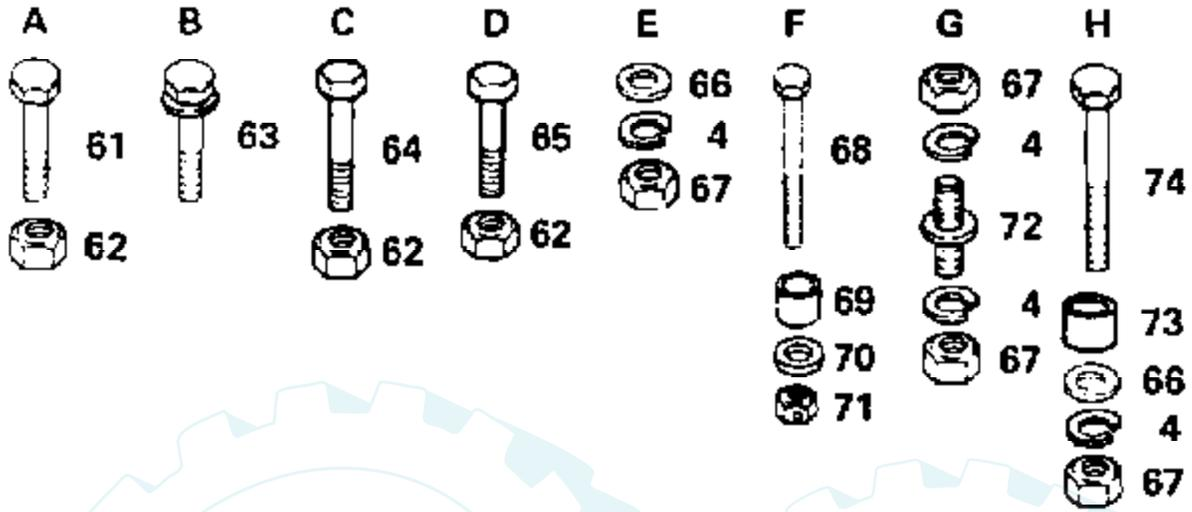

Ref #	Part Number	Qty	Description
4	10040600		LOCKWASHER
61	74760612		SUB= 74780612
62	73680600		SUB= 73690600
63	17490612		SCREW
64	74780616		BOLT
65	74760616		BOLT
66	19131413		WASHER
67	73220600		NUT.HEX.3/8-16UNC
68	74930516		BOLT GT
69	100644K		BUSHING LT
70	19111416		WASHER
71	73680500		SUB= 73690500
72	106615X		SUB= 677A928
73	102933X		SPLIT SPACER YTV
74	74760632		SUB= 74930632

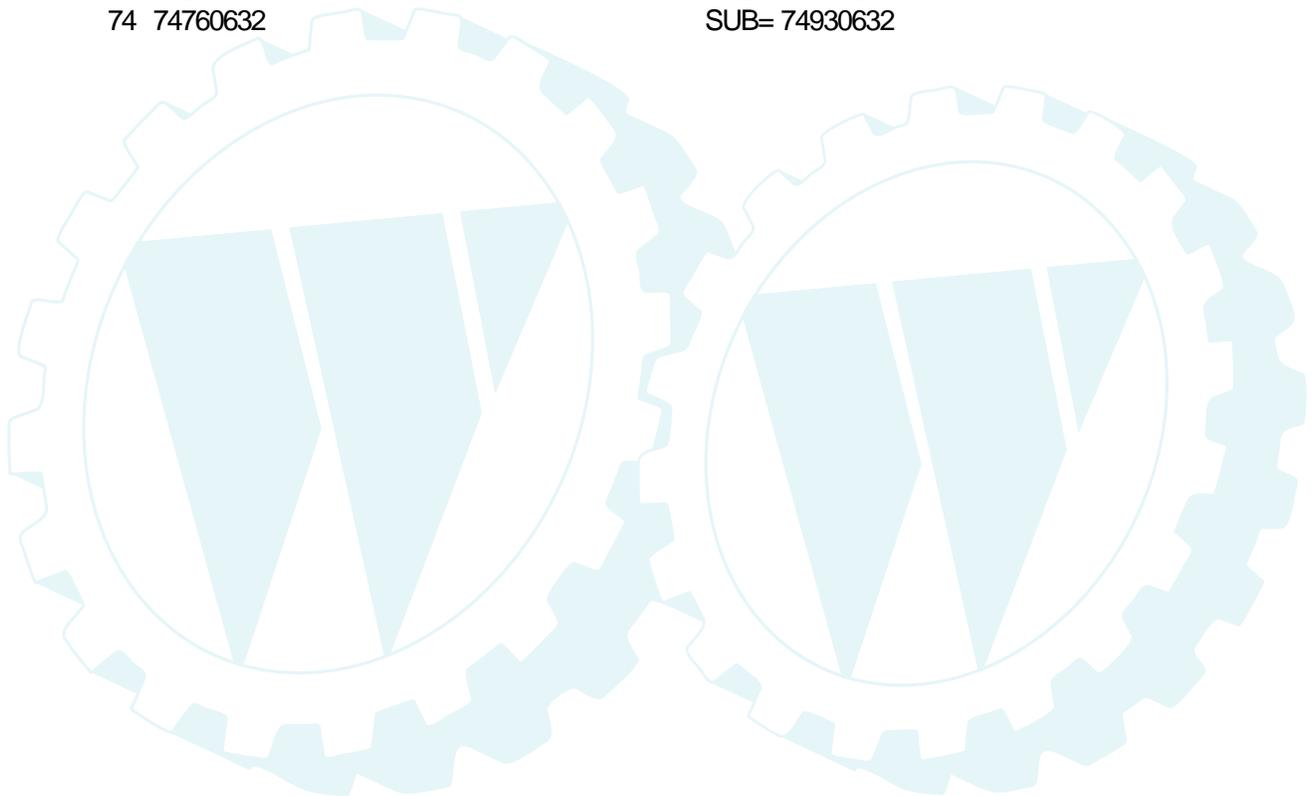

ROPER GT TRACTOR--MODEL NUMBERS GT180BR AND GT180BT

MOWER

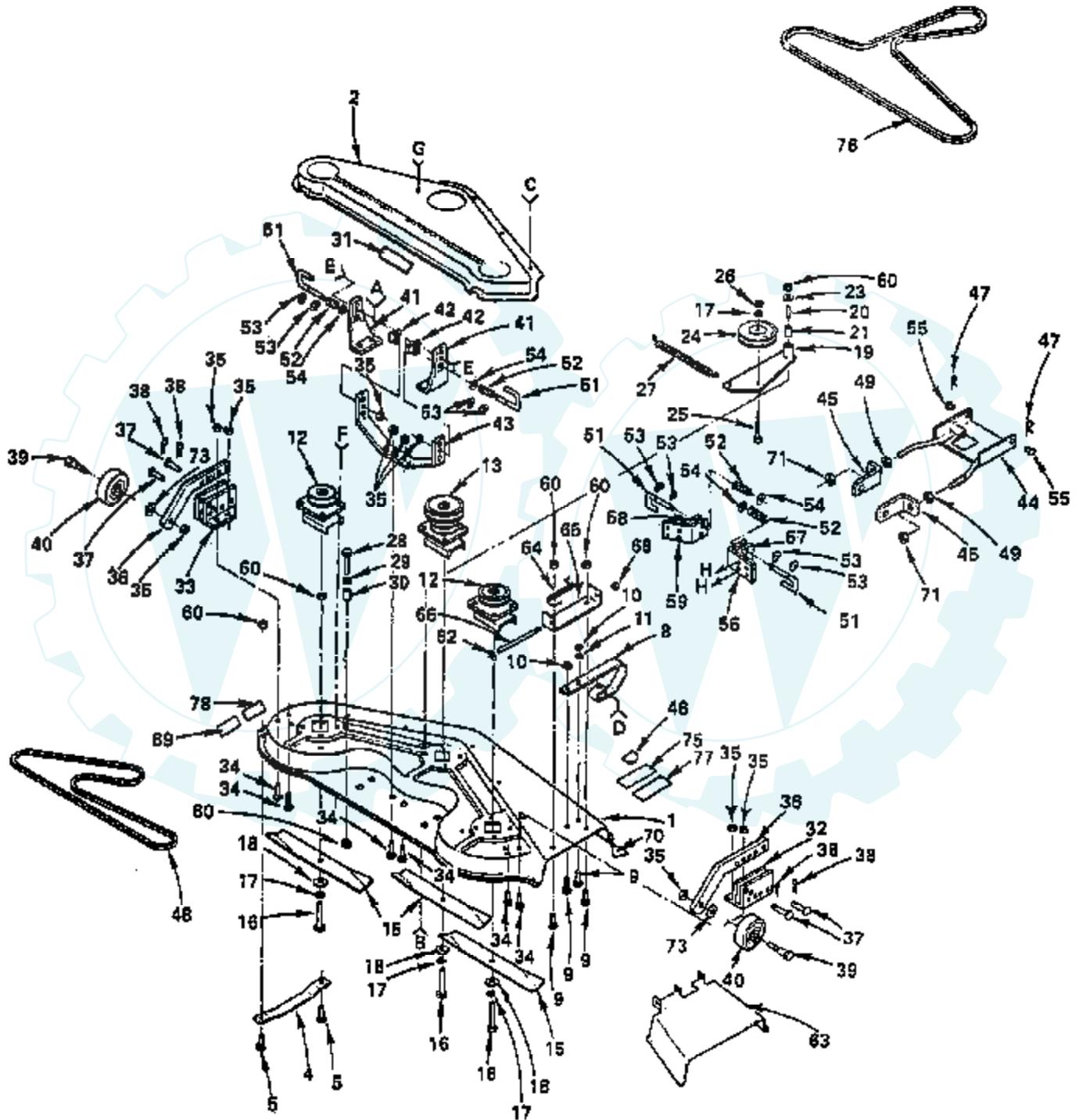

Ref #	Part Number	Qty	Description
1	105415X		SUB= 144730
2	106022X		DECK DRV COVE T
4	7631J		RUNNER-LH M
5	72110505		BOLT
8	8418J		SUB= 136321
9	72140506		BOLT
10	1685H		SUB= 68478
11	19111116		WASHER
12	105483X		SUB= 136819
13	105477X		SUB= 121657X
15	106635X		SUB= 25034
16	74610624		BOLT.3/8-24X1-1/2
17	10040600		LOCKWASHER
18	19132012		WASHER
19	674A213		ARM ASSY GT
20	7834J		SUB= 674A308
21	7835J		SUB= 674A308
23	19111610		WASHER
24	102403X		IDLER-FLAT T
25	74760624		SUB= 74930624
26	73220600		NUT.HEX.3/8-16UNC
27	104361X		SPRING T
28	74780520		BOLT
29	19111216		WASHER M
30	8438J		SPACER SPLIT LT
31	106224X		SUB= 139346
32	105448X		GUAGE WHL BRKT GT
33	105449X		GUAGE WHL BRKT GT
34	72240606		BOLT
35	73680600		SUB= 73690600
36	105453X		GUAGE WHL BAR GT
37	5565J		SUB= 139031
38	4939M		SUB= 85902
39	4898H		BOLT M
40	105455X		WHEEL.GAGE.BLK.PL
41	105433X		SUSP BRKT GT
42	105430X		SUB= 110237X
43	105434X		SUSP BRACE GT
44	105436X		SUSP PLATE GT
45	105441X		SUSP BRKT GT
46	78850		SUB= 85463
46	107339X		DECAL HYT
47	3146R		RETAINER.SPRING
48	106381X		V-BELT
49	73680800		NUT LTV
51	105435X		RELEASE PIN GT
52	3720R		SPRING M
53	12000039		KLIP RING
54	19171612		WASHER GT
55	105440X		CLEVIS PIN GT
56	105456X		OUTER BRKT RH GT
57	105460X		INNER BRKT RH GT
58	105461X		INNER BRKT LH GT
59	105457X		OUTER BRKT LH GT
60	73680500		SUB= 73690500
62	19111016		WASHER
63	105895X		SUB= 109785X
64	106734X		SUB= 123713X

Ref #	Part Number	Qty	Description
65	105896X		SUB= 137607
66	106735X		ROD-HINGE T
68	5846R		SUB= 110452X
69	3713J		DECAL INSTRUCTION CAUTION
70	106975X		DECAL - SAFETY STANDARD
71	73220800		NUT
73	19171512		WASHER
75	106679X		DECAL.WARNING.T
76	106863X		SUB= 108597X
77	108695X		SUB= 106679X
78	105185X		DECAL-INST YT
	200174X		COMPLETE MOWER DECK ASSY

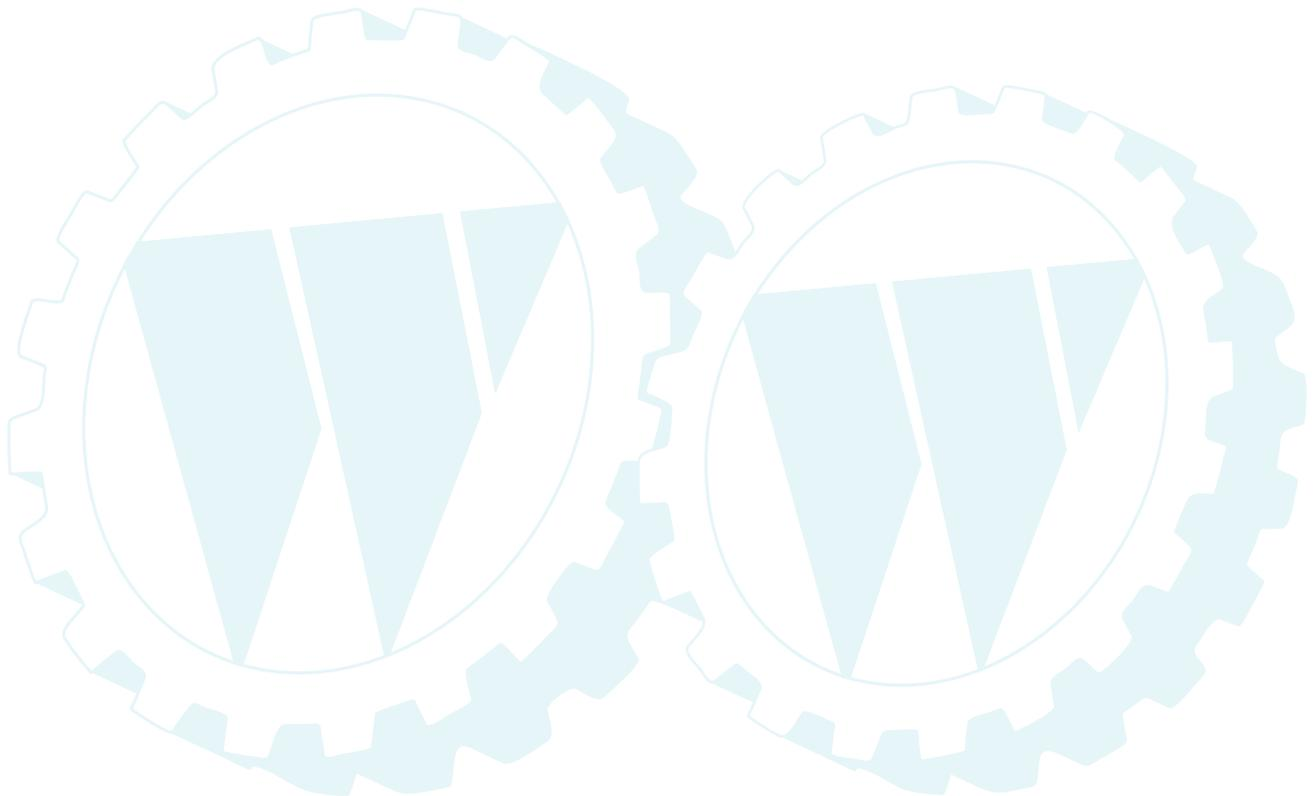

ROPER GT TRACTOR--MODEL NUMBERS GT180BR AND GT180BT

MOWER LIFT

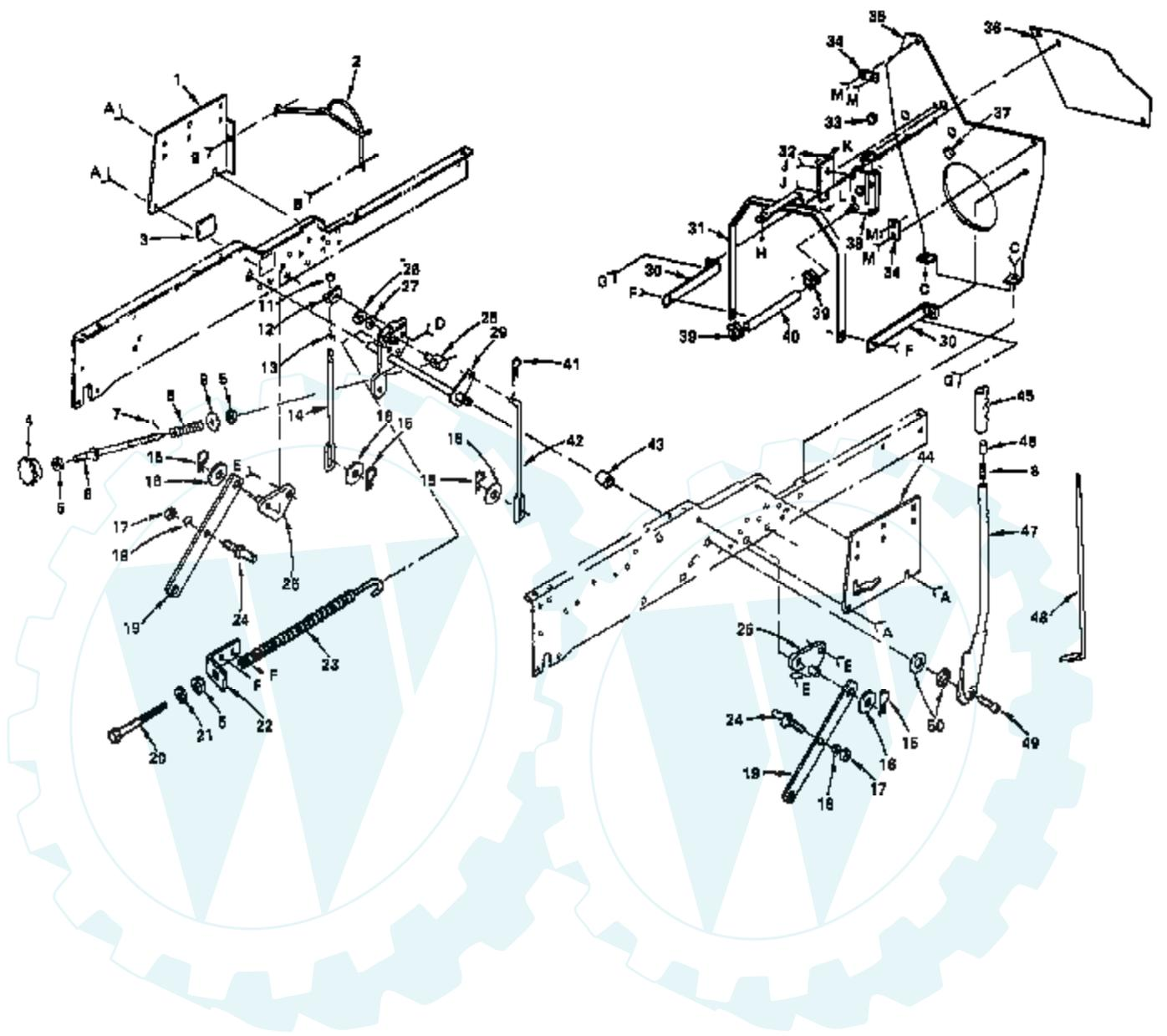

Ref #	Part Number	Qty	Description
1	106793X		SUB= 532121046
2	105589X		ENGINE BELT GUARD
3	105505X		SUB= 121794X
4	100734K		SUB= 138057
5	73350600		NUT
6	106318X		ADJ ROD GT
7	76020308		SUB= 3145
8	2876H		SPRING T
9	19131016		WASHER
11	73800600		NUT
12	7594J		BRACKET T
13	73220600		NUT.HEX.3/8-16UNC
14	7596J		LINK-LIFT MOW T
15	9135R		SPRING H
16	19171713		SUB= 146537
17	73220800		NUT
18	10040800		LOCKWASHER
19	105429X		SUSPENSION ARM GT
20	5328J		BOLT-ADJ SPRING T
23	674A247		SUB= 918674A247
25	105413X		PIVOT STUD GT
25	105501X		SUSP BRACKET T
26	12000037		KLIP RING
27	19151216		WASHER
28	6519J		TRUNION T
29	105633X		LIFT SHAFT GT
30	104649X		BRKT-SHIELD, HEAT, SIDE
31	106872X		SUB= 532128141
32	105040X		BRACKET GT
33	9151R		SNAP BUSHING T
34	105105X		STRAP, TIE
36	108125X		PANEL-SHIELD, HEAT
37	106351X		PLUG GT
38	105041X		SUB= 129979
39	6999R		SUB= 123487X
40	3008J		SUB= 7833R
41	4939M		SUB= 85902
42	105503X		LIFT LINK RH T
43	106012X		SPACER GT
44	106792X		SUB= 532121045
45	106019X		SUB= 109413X
46	105723X		SUB= 125925X
47	106645X		SUB= 123096X
48	106644X		SUB= 121006X
49	74570632		SCREW LT
50	105630X		WASHER YT

ROPER GT TRACTOR--MODEL NUMBERS GT180BR AND GT180BT

STEERING

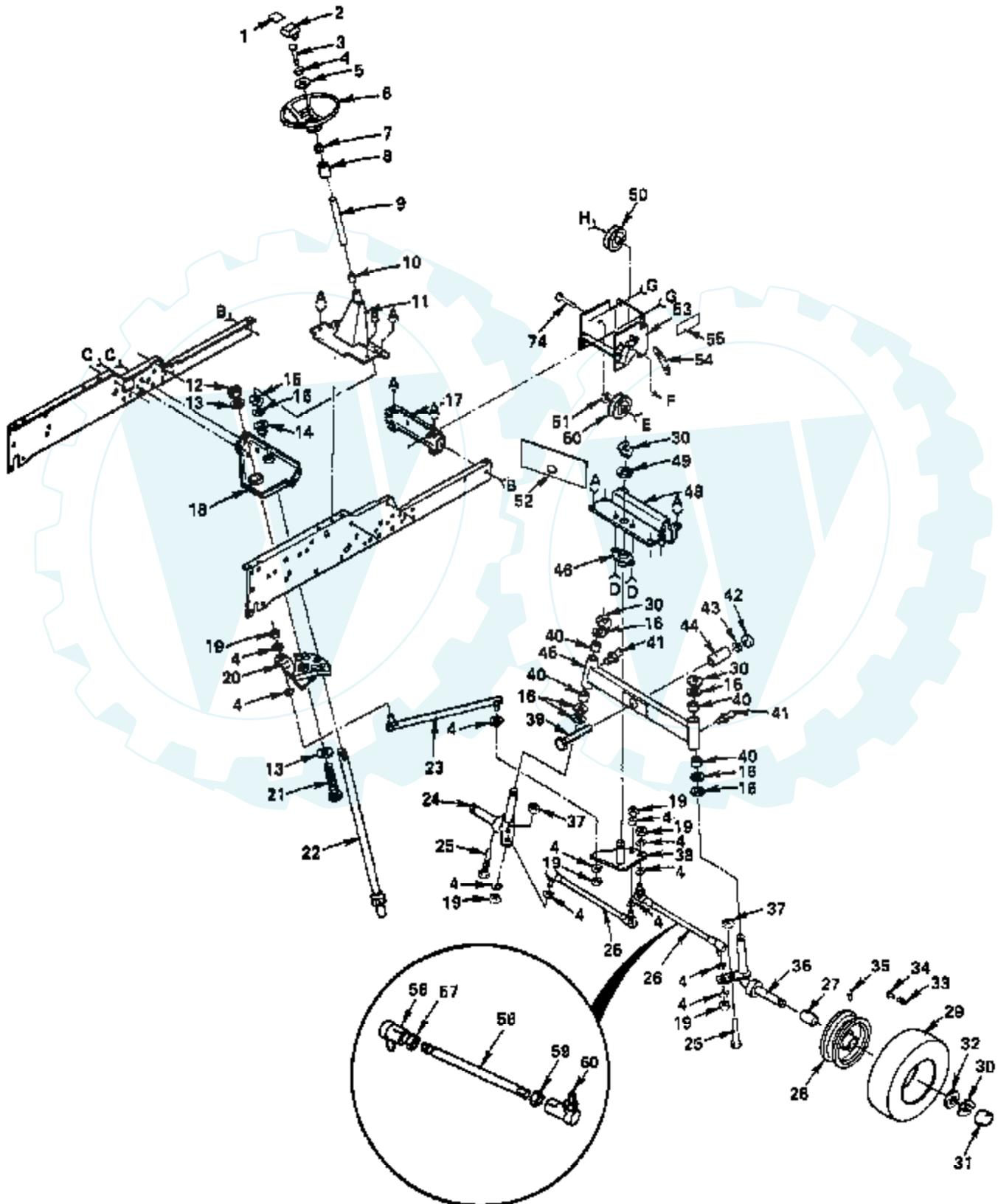

Ref #	Part Number	Qty	Description
1	104590X		DECAL - STEERING WHEEL
2	100710L		INSERT-WHEEL LT
3	74780616		BOLT
4	10040600		LOCKWASHER
5	67354		SUB= 19133808
6	100713N		SUB= 150547
7	100711L		ADAPTER LT
8	106943X		SPACER LT
9	108540X		TUBE
10	9038R		"T, BEARING"
11	101274N		SUPPORT ASSY T
12	73680800		NUT LTV
13	19172610		WASHER GT
14	104239X		"FLANGE GT, BEAR."
15	12000034		KLIP RING
16	6266H		WASHER .T
17	5213J		FRAME BRACKET GT
18	102439X		SUB= 144668
19	73610600		SUB= 7810H
20	108134X		SECTOR ASM
21	74760832		BOLT
22	104591X		SHAFT STEERING GT
23	5293J		NLA
24	106046X		SPINDLE ASSY T
25	74520632		BOLT, HEX 3/8 - 16 X 2
26	7990J		SUB= 109849X
27	9040H		"FLANGE, BEARING"
28	9541R		SUB= 106228X417
29	3938R		SUB= 122075X
	8134H		TUBE.16X6.5/7.5-8
30	12000029		RING
31	104757X		HUB CAP
32	19252016		SUB= 121749X
33	59192		VALVE CAP
34	65139		VALVE STEM LT
35	278H		FITTING LT
36	106045X		SPINDLE RH T
37	73510600		NUT
38	108137X		"T, BELLCRANK"
39	74781044		BOLT
40	1309H		BRNG. T
41	6855M		ZERK M
42	73221000		NUT X
43	10041000		WASHER
44	5298J		SUB= 136518
45	674A244		SUB= 674A243
46	5292J		SUB= 140342
47	100207K		CLIP GTV
48	5284J		AXLE BRACKET T
49	19292016		WASHER
50	677A451		IDLER-INSIDE T
51	19132007		WASHER T
52	104989X		NLA
53	108253X		SUB= 120542X
54	7190J		SPRING
55	108367X		DECAL T
56	8922R		SUB= 109851X
57	73700600		NUT

Ref #	Part Number	Qty	Description
58	7919J		SUB= 121159X
59	73360600		NUT
60	8921R		SUB= 109850X
74	74760632		SUB= 74930632

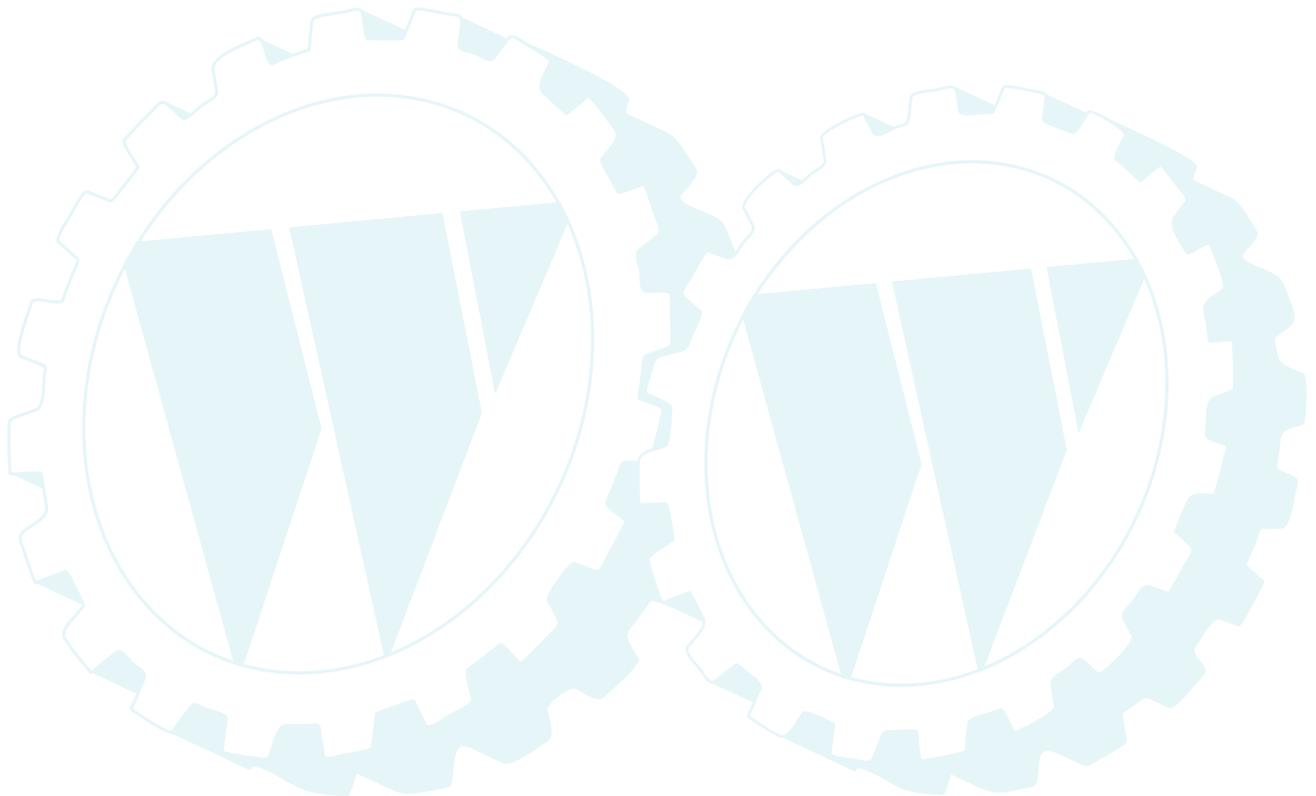

ROPER GT TRACTOR--MODEL NUMBERS GT180BR AND GT180BT

TRANSAXLE

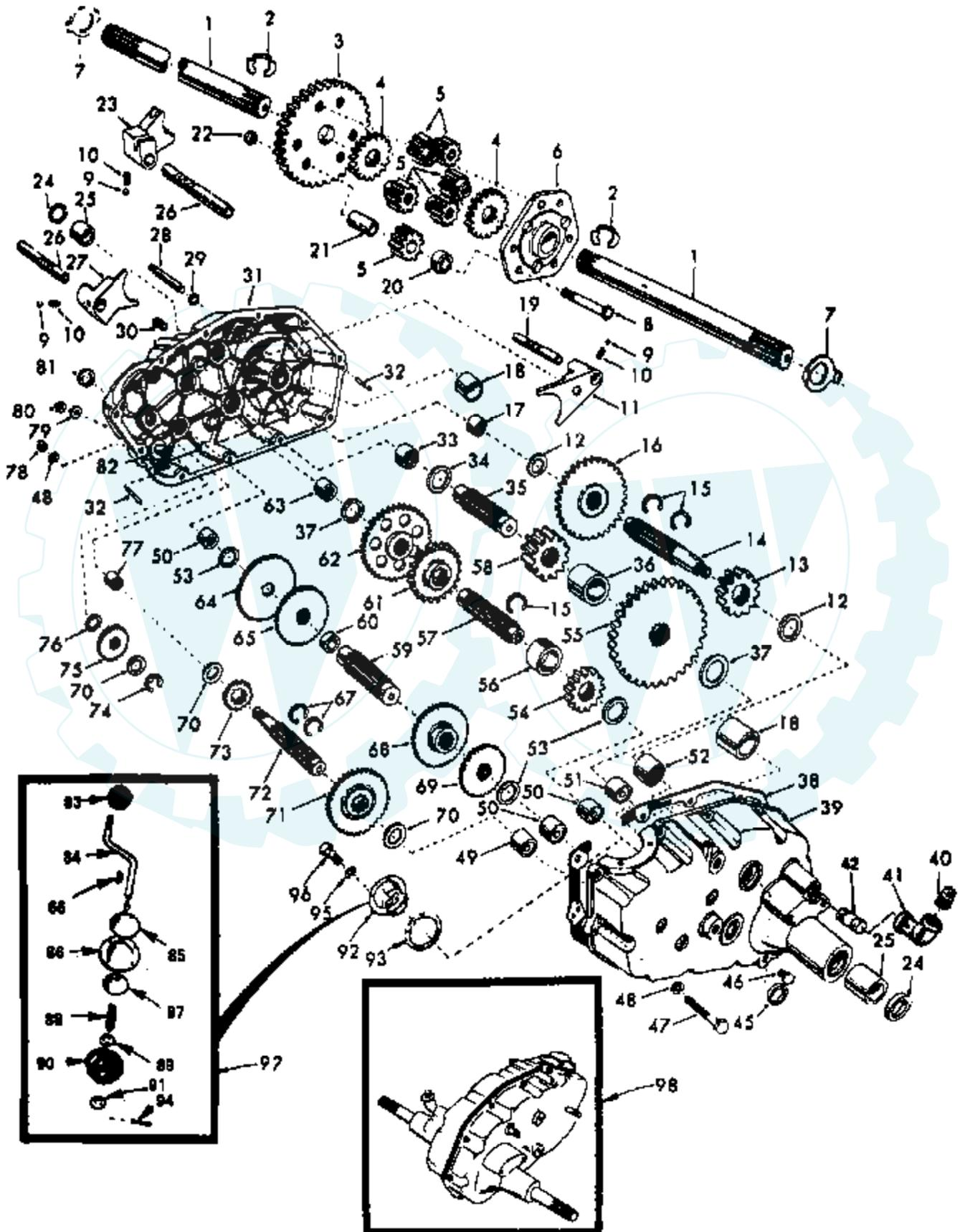

Ref #	Part Number	Qty	Description
1	4197R		SHAFT.AXLE.T
2	5845R		SUB= 12000034
3	4199R		FINAL GEAR T
4	4216R		DIFF GEAR T
5	4215R		DIFF PINION T
6	4217R		DIFF CARRIER T
7	6256H		WASHER T
8	74020652		BOLT
9	7392M		SUB= 100482K
10	6272H		SUB= 145359
11	4985R		SHIFT FORK T
12	6266H		WASHER .T
13	4212R		RED PINION T
14	4196R		GEAR SHAFT T
15	6276H		SNAP RING T
16	633A63		GEAR T
17	8118M		"T, BEARING"
18	8740H1		BEARING
19	6217H		SUB= 122238X
20	4218R		SPACER T
21	6252H1		PINION RS
22	7810H		GRIPCO NUT
23	4986R		SHIFT FORK T
24	7393R		OIL SEAL STD
25	992R1		BRNG. T
26	6216H		SHAFT T
27	6262H		FORK T
28	101416X		SHIFT SHAFT GTV
29	6269H		SEAL T
30	5855H		VALVE M
31	101414X		GEARCASE HALF G
32	6277H		PIN T
33	4225R		NEEDLE BRNG T
34	7396H		RACE T
35	4198R		GEAR SHAFT T
36	4200R		SUB= 532004200
37	7395H		RACE T
38	6275H		SUB= 121878X
39	633A64		NLA
40	13060400		SUB= 13320400
41	13200400		NLA
42	13280424		NIPPLE
45	6217H		SUB= 122238X
46	13060200		SUB= 13020200
47	74780524		HEX BOLT
48	10140500		SUB= 10040500
49	4895H		"TI, BEARING"
50	4222R		NEEDLE BRNG T
51	1529R		NEEDLE BRNG T
52	8119M		"STD, BEARING"
53	4220R		BRNG RACE
54	4209R		RED PINION T
55	4213R		RED GEAR T
56	4442R		PINION SPACER T
57	4195R		GEAR SHAFT T
58	4214R		FINAL PINION T
59	4194R		GEAR SHAFT T
60	7528R		SPACER T

Ref #	Part Number	Qty	Description
61	4208R		RED PINION T
62	4207R		RED GEAR T
63	7398H		RACE T
64	4203R		LOW SPEED GEA T
65	4204R		REVERSE GEAR T
66	2898J		KEY T
67	4926H		RING STD
68	4205R		INTERMED GEAR T
69	4206R		SUB= 532004206
70	1370H		"T, BEARING"
71	633A69		CLUSTER GEAR T
72	208J		INPUT SHAFT T
73	4201R		LO SPEED PINION T
74	12000002		SUB= 2225J
75	1153R		IDLER GEAR T
76	7392H		WASHER T
77	3990H		BRNG T
78	73220500		NUT.HEX.5/16-18
79	1167R		WASHER T
80	73360700		NUT
81	6270H		SEAL STD
82	7384H		SHAFT T
83	100196K		SUB= 106932X
84	5384J		GEAR SHIFT LVR T
85	2978J		CAP T
86	633A85		COVER AND PIN T
87	8739H1		GUIDE BALL T
88	4924H		SPRING TI
89	19151516		WASHER
90	8105R		SUB= 110542X
91	19181511		WASHER
92	75J		GEAR SHIFT GA T
93	6274H		GASKET T
94	76020412		COTTER PIN
95	10040500		LOCKWASHER
96	74760514		BOLT
97	633A109		GEAR SHFT LVR T
98	101340R		SUB= 105474X