

12.5 HP LAWN TRACTOR - MODEL NUMBER 3380-14

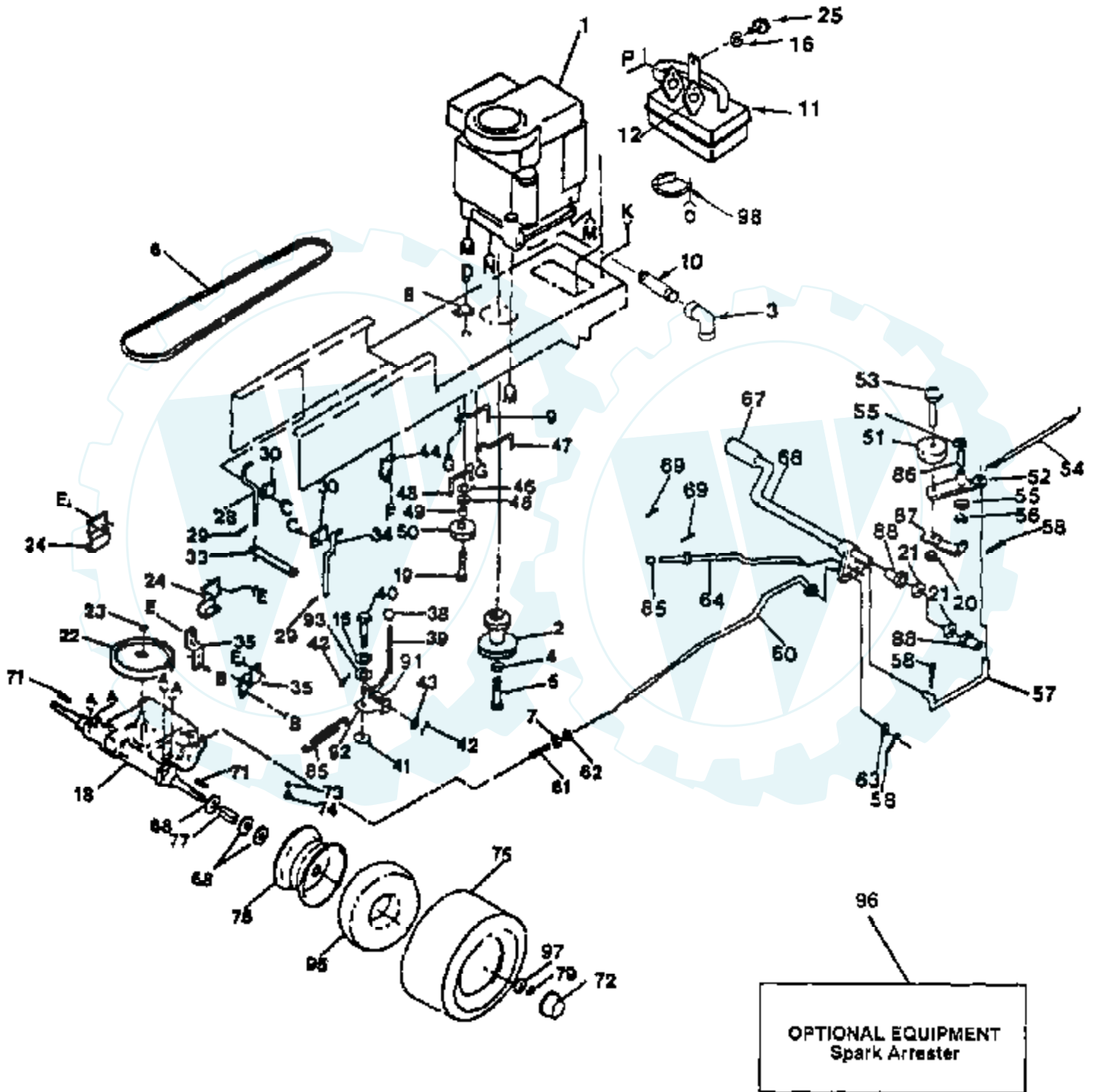

Ref #	Part Number	Qty	Description
1	127690		ENGINE
2	105731X		SUB= 137326
3	13200300		ELBOW
4	10040700		LOCKWASHER
5	71130720		BOLT
6	125907X		BELT-V.90.0.GD.DR
7	73800600		NUT
8	2751R		CLIP T
9	121218X		KEEPER BELT ENGLH
10	13280324		PIPE NIPPLE
11	120330X		MUFFLER LT
12	2949R		SUB= 272293
16	10040400		LOCKWASHER
18	120898X		SUB= 137367
19	74760644		BOLT
20	73680600		SUB= 73690600
21	19211616		WASHER LT
22	123666X		PULLEY TRANS
23	12000028		SUB= 2267J
24	109167X		BRACKET LT
25	74760616		BOLT
28	123662X		KEEPER BELT LH
29	4921H		SPRING.RETAINER
30	106190X		CLAMP LT
33	123770X		STRAP LOCATOR
34	123663X		KEEPER BELTRH
35	121520X		STRAP TORQUE
38	106933X		KNOB T (1/2-HOLE)
39	124461X		ROD SHIFTER
40	71040412		SUB= 74550412
41	105701X		WASH-SHFT PLT LT
42	76020416		PIN COTTER 1/8
43	19151216		WASHER
44	104777X		SUB= 140312
46	19131312		WASHER
47	105730X		"KEEPER,BLT ENG LT"
48	109070X		BELT KEEPER LT
49	4470J		SPACER T
50	123674X		PULLEY.IDLER.FLAT
51	123766X		SUB= 139245
52	123789X		ARM IDLER
53	74760624		SUB= 74930624
54	105709X		"SPRING, RETURN LT"
55	110812X		WASHER LT
56	12000039		KLIP RING
57	105710X		"LINK, CLUTCH T"
58	76020412		COTTER PIN
60	110437X		BRAKE ROD LT
61	106888X		SPRING ROD LT
62	73350600		NUT
63	19131316		WASHER
64	125638X		SUB= 128904
65	71673		PLUNGER CAP T
66	122424X		SUB= 149001
67	8883R		PEDAL COVER T
68	121749X		WASHER
69	1572H		SUB= 2882J
71	123583X		SQUARE KEY

Ref #	Part Number	Qty	Description
72	104757X		HUB CAP
73	59192		VALVE CAP
74	65139		VALVE STEM LT
75	106268X		SUB= 122074X
76	106108X361		SUB= 106108X417
77	109502X		SPACER LT
79	12000001		E-RING LT
85	110422X		SUB= 146682
86	105706X		"LY, BEARING"
87	123205X		RETAIN BELT
88	120183X		NYLON BEARING
91	105700X		SPRING LT
92	106919X		PLATE SHIFT LT
93	19091210		WASHER LT
95	7152J		TUBE.18X9.5-8
96	123110X		SPARK ARREST KIT
97	121748X		WASHER
98	101326L		DEFLECTOR.222573
	121120X		DECAL
	129057		SUB= 532129057

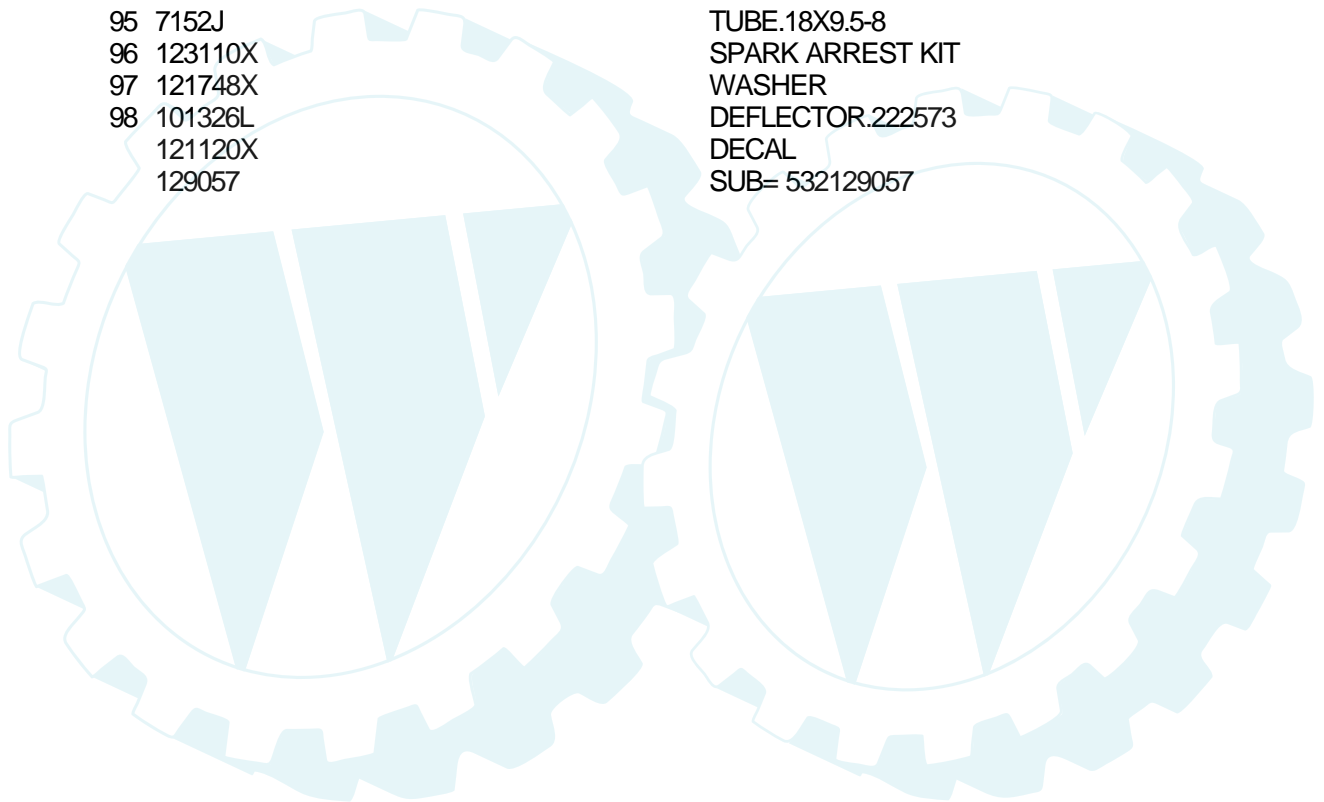

12.5 HP LAWN TRACTOR - MODEL NUMBER 3380-14

38" MOWER

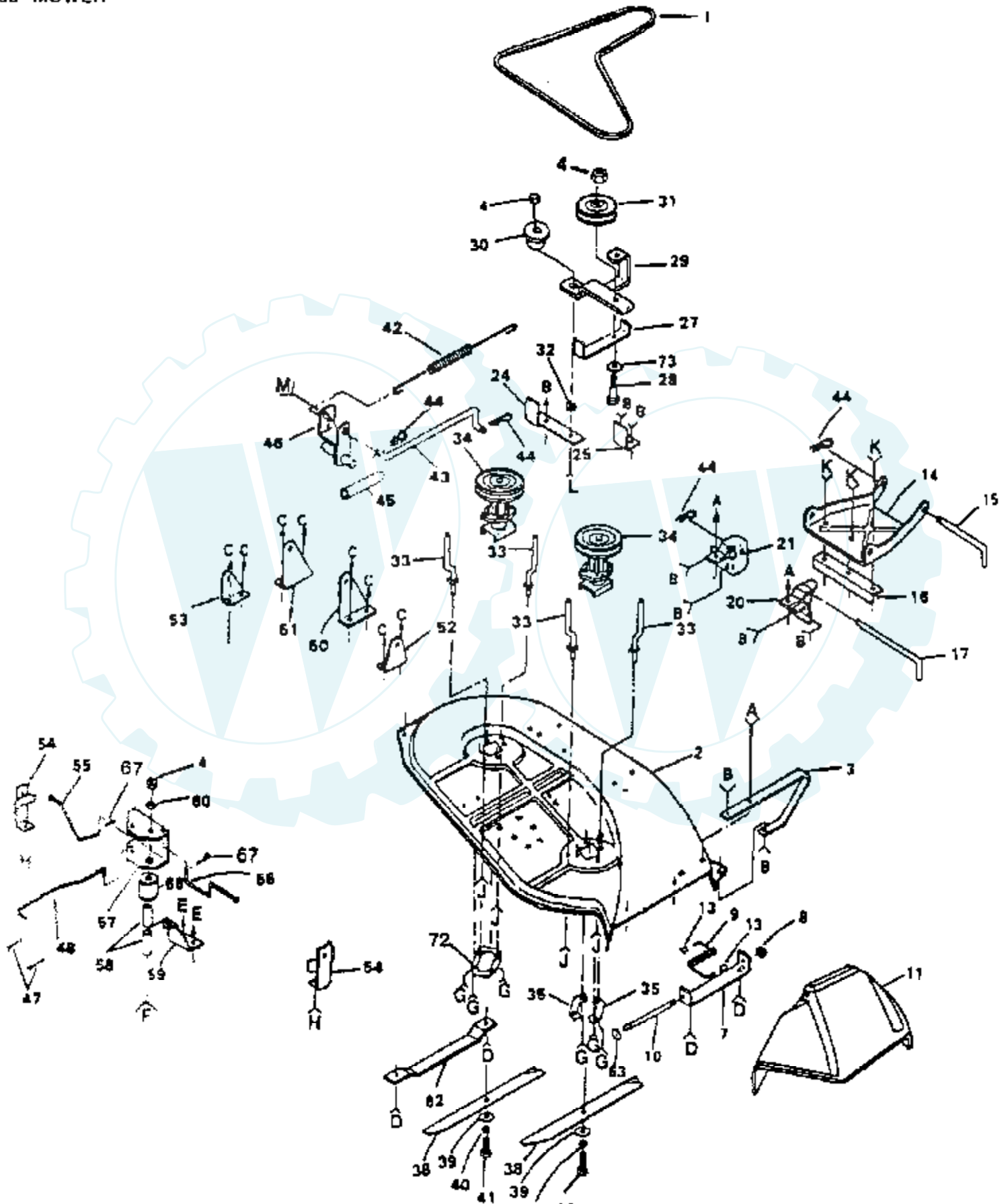

Ref #	Part Number	Qty	Description
1	106085X		BELT-V.79.1.MWR
2	121259X		SUB= 144725
3	8417J		SUB= 128772
4	73680600		SUB= 73690600
7	105896X		SUB= 137607
8	110452X		NUT PUSH M
9	106734X		SUB= 123713X
10	106735X		ROD-HINGE T
11	106736X		DEFLECTOR-SHLD T
13	105304X		CAP-SLEEVE LT
14	105662X		LINK.PARALLEL
15	105744X		"ROD, FRT. PARAL T"
16	105872X		LINK STOP
17	109835X		HINGE PIN T
20	109598X		BRACKET RH LT
21	109597X		BRACKET LH T
24	109503X		SUPPORT ARM T
25	109504X		STOP T
27	126756X		GUIDE.BELT
28	74760632		SUB= 74930632
29	127163X		"ARM,IDLER"
30	106902X		SPACER RETAINER
31	123688X		SUB= 121316X
32	106513X		"WASHER, WEAR LT"
33	102669X		BELT KEEPER LT
34	121676X		SUB= 121687X
35	100668L		SUPPORT PLATE LT
38	121263X		"BLADE.38"" HI-LI"
39	19132012		WASHER
40	10030600		SUB= 10040600
41	74610624		BOLT.3/8-24X1-1/2
42	108250X		SPRING LT
43	108235X		ROD LT
44	4921H		SPRING.RETAINER
45	6404J		SPACER T
46	124066X		SUB= 109892X
47	76020616		SUB= 76020624
48	108247X		ROD BRAKE LT
50	108243X		BRACKET LT
51	108241X		BRACKET LT
52	105857X		"BRKT,SUSP RH T"
53	108673X		"BRKT,SUSP REAR LH"
54	106578X		BRAKE LT
55	106463X		"ROD, BRAKE LH LT"
56	108249X		ROD BRAKE LT
57	106456X		"BRK,BRAKE,PVT LT"
58	100672K		SPACER BRAKE LTV
59	100673L		BRACKET SUPT LTV
60	19131614		WASHER
62	7631J		RUNNER-LH M
63	19111016		WASHER
66	122314X		SPACER
67	76020308		SUB= 3145
72	110445X		SUPPORT T
73	19131316		WASHER
	123928X		MOWER ASSY
	105814X		DECAL LT
	109820X		DECAL YT

Ref #	Part Number	Qty	Description
	121349X		DECAL WARNING



12.5 HP LAWN TRACTOR - MODEL NUMBER 3380-14

ELECTRICAL

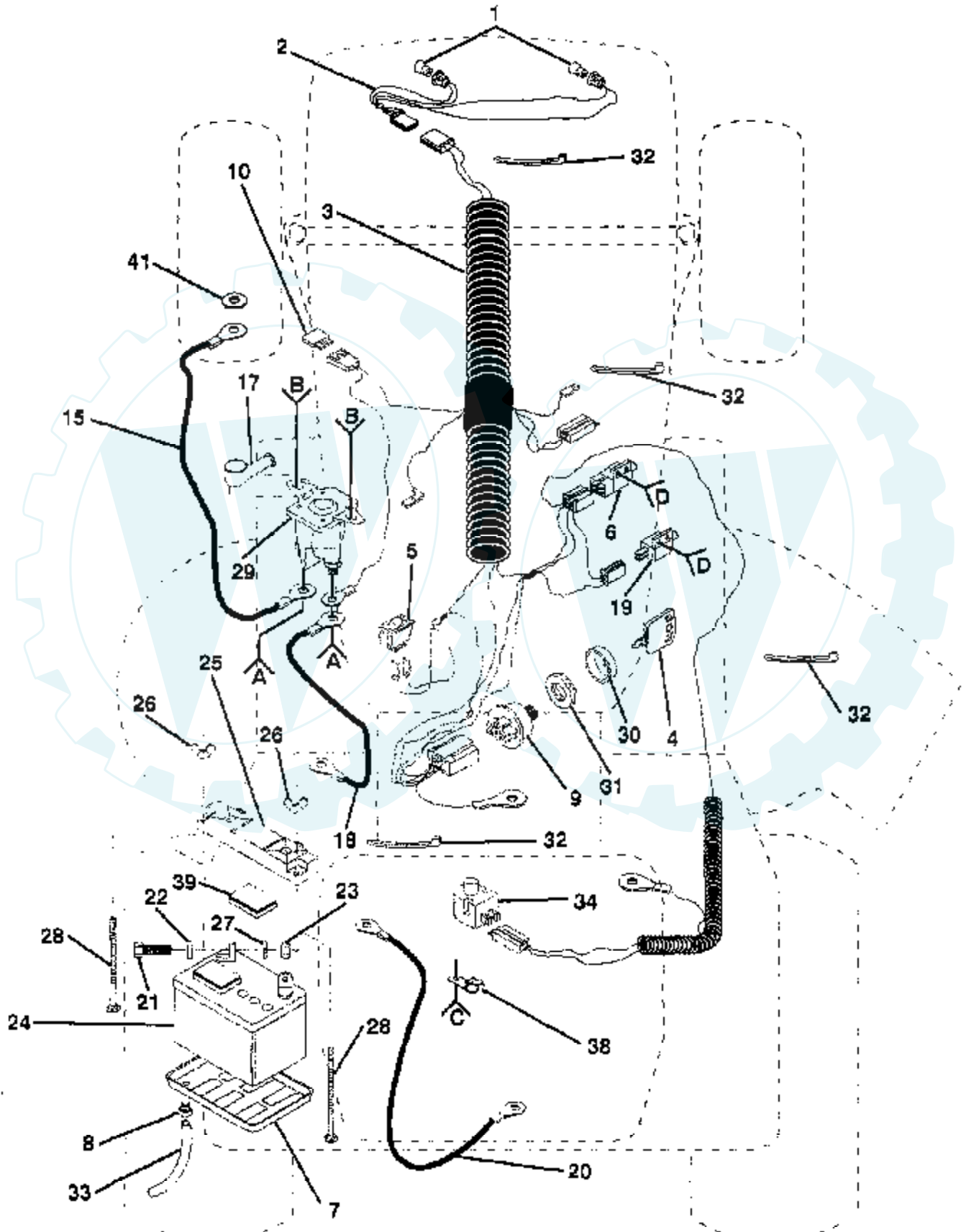

Ref #	Part Number	Qty	Description
1	7662J		SUB= 4152J
2	110859X		HARNESS T
3	124904X		"HARNESS,WIRING"
4	122147X		KEY
5	110712X		SWITCH LT
6	104445X		SWITCH-INTER. GT
7	7603J		"TRAY T, BATTERY"
8	109596X		HOSE CLAMP T
9	4406R		SUB= STD365402
10	108824X		FUSE HYT
15	4207J		CABLE T
17	719J		SUB= 154336
18	5114J		STARTER CABLE GT
19	109553X		SWITCH INTERLOCKT
20	108423X		CABLE ASM.
21	74760412		BOLT LT
22	19091016		WASHER
23	73220400		SUB= 50675
24	121265X		SUB= 123899X
25	102476X		SUB= 150109
26	123198X		SUB= 146525
27	10040400		LOCKWASHER
28	72240460		BOLT
29	109081X		SUB= 146154
30	109787X		SUB= 147626
31	109788X		SUB= 124211X
32	7192J		WIRE TIE
33	105687X		SUB= 109238X
34	121305X		SWITCH SEAT
38	4171R		CLIP T
39	121264X		"CAP,BATTERY "
41	11050400		LOCKWASHER
	101539X		SHEET INSTR LT
	127991		MANUAL, REPAIR PARTS
	127903		NLA
	121549X		DECAL

ENCLOSURE

12.5 HP LAWN TRACTOR - MODEL NUMBER 3380-14

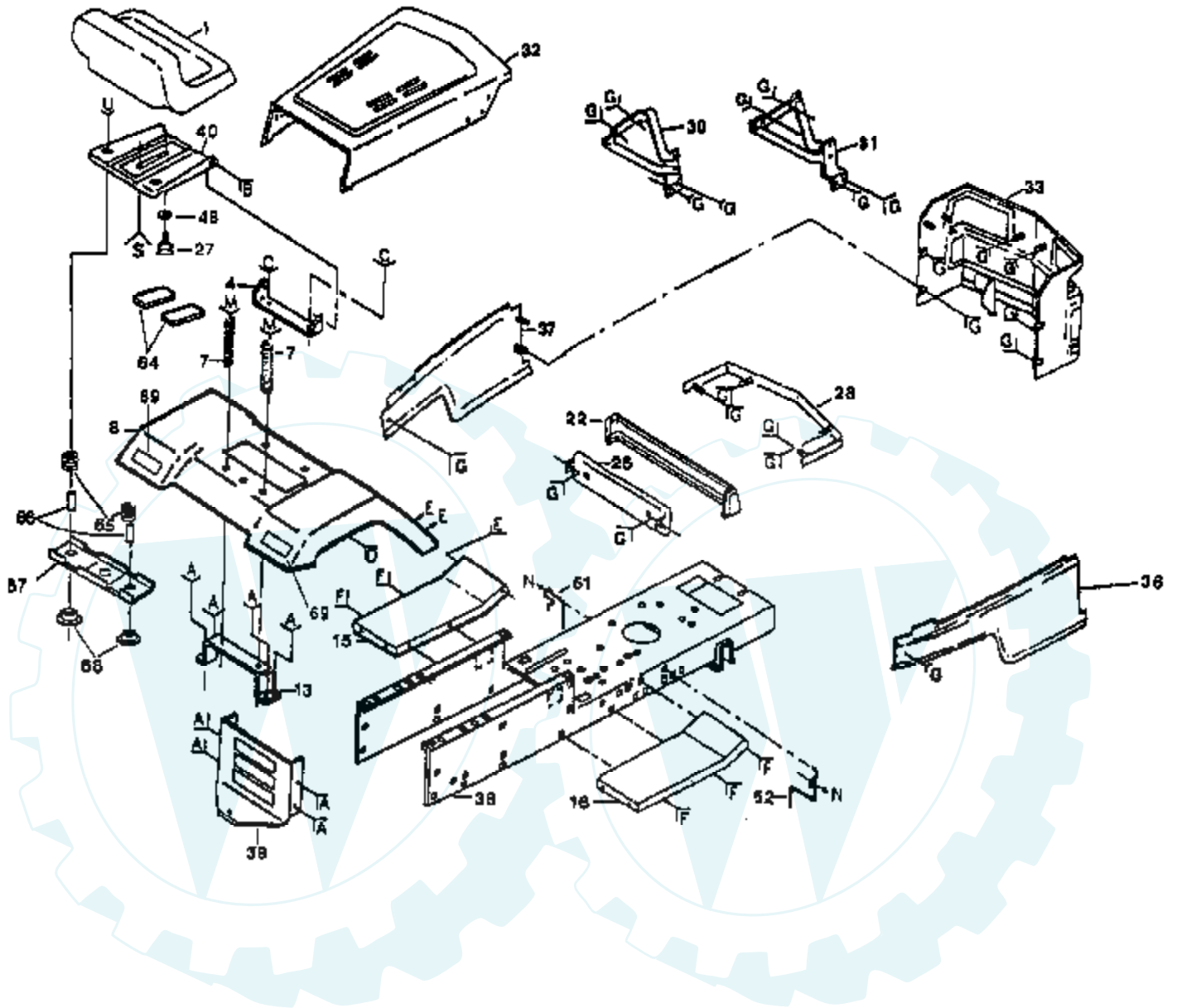

Ref #	Part Number	Qty	Description
1	127429X		SUB= 140121
7	124181X		SPRING COMPRESSIO
8	109872X424		FENDER
13	109873X		SUB= 136619
15	105465X424		SUB= 145244X424
16	105464X424		SUB= 145243X424
22	124400X		SUB= 133954
26	110897X		SUB= 132257
27	120068X		"KNOB 1/2" YT"
28	109745X424		"STRAP,GRILL"
30	105797X		"HINGE,HOOD,LH T"
31	105792X		"HINGE,HOOD,RH T"
32	105682X424		SUB= 128561X424
33	128312		GRILL
36	106927X424		"PANEL,SIDE RH"
37	106929X424		"PANEL,SIDE LH"
38	127168X		CHASSIS ASS'Y
39	127866		DRAWBAR LT/YT
40	124294X		SUB= 155925
48	19171912		WASHER
51	121440X		BELT GUIDE
52	121441X		BELT GUIDE
64	121251X		STRIP FORM
65	123740X		SPRING COMPRESSED
66	121249X		SPACER SPLIT
67	121246X		BRKT SWITCH
68	121248X		BUSHING
69	106202		SUB= 106202X
	129685		DECAL, HOOD
	109199X		SUB= 146046
	129686		DECAL, HOOD

12.5 HP LAWN TRACTOR - MODEL NUMBER 3380-14

LIFT ADJUSTMENT

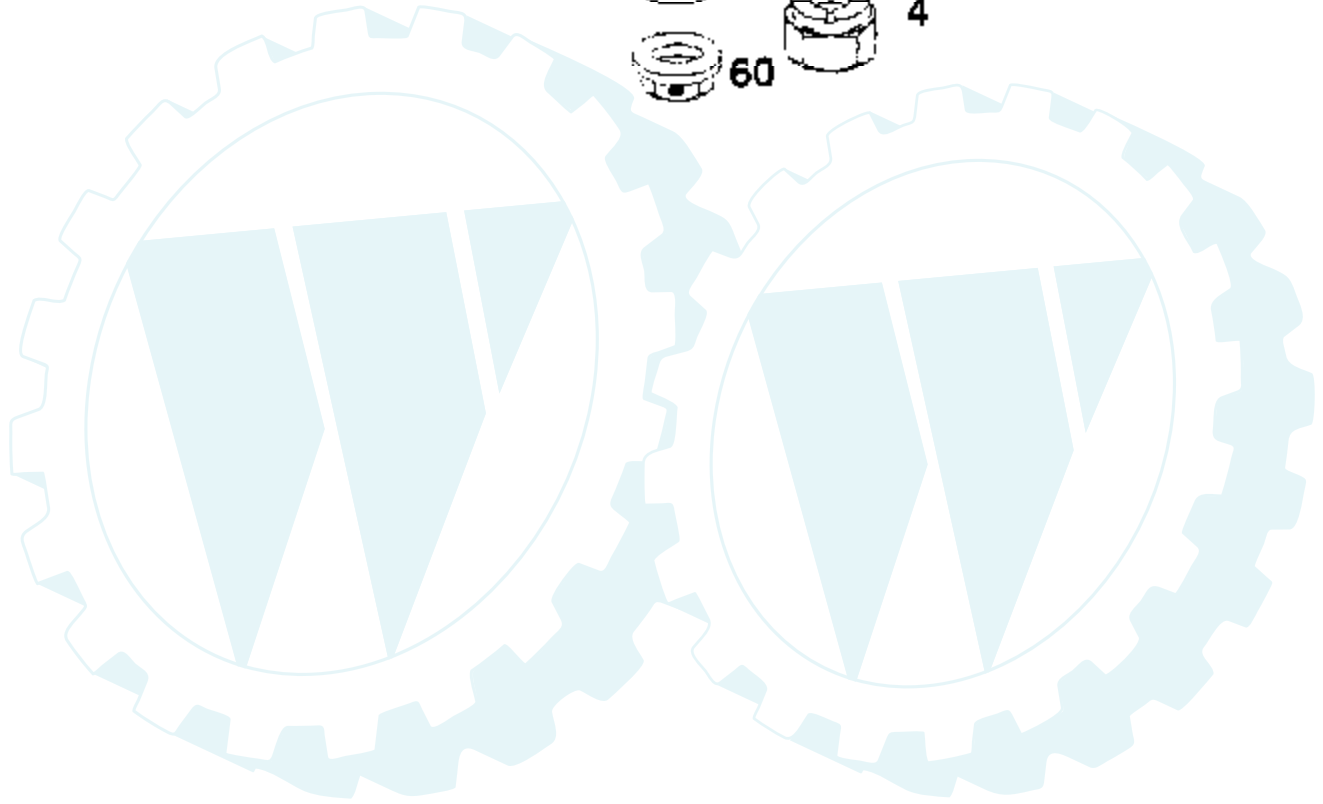
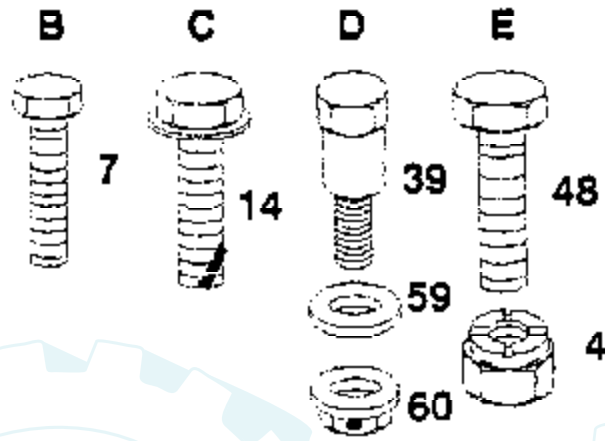

Ref #	Part Number	Qty	Description
4	73680600		SUB= 73690600
7	17021008		SCREW
14	17490412		SCREW HEX CRT
39	105848X		"BOLT, SHOULDER LT"
48	74760612		SUB= 74780612
59	110739X		WASHER T
60	73980600		NUT SPECIAL T



12.5 HP LAWN TRACTOR - MODEL NUMBER 3380-14

STEERING AND FRONT AXLE

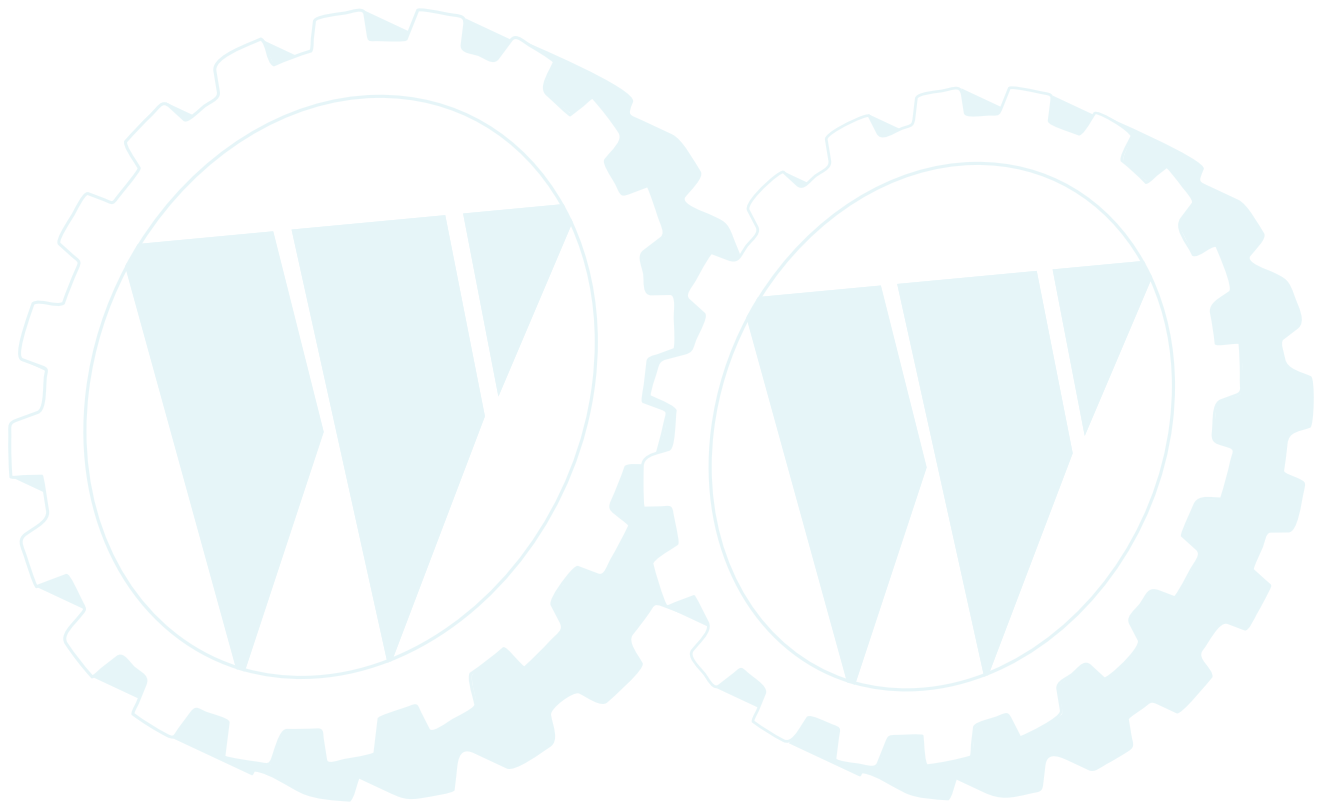
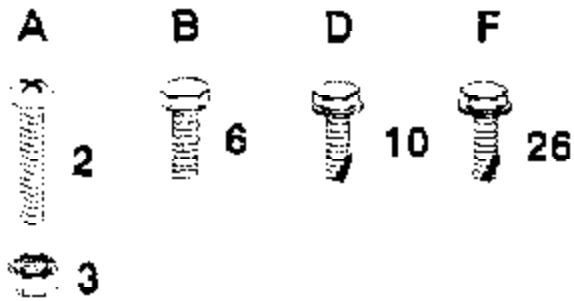





















Ref #	Part Number	Qty	Description
2	74180512		SCREW
3	73510500		NUT
6	17720410		SCREW LT
10	17490608		SCREW LT
26	17490612		SCREW
	127026		DECAL, INSERT
	129493		DECAL, STEERING WHEEL
	109821X		SUB= 138956



12.5 HP LAWN TRACTOR - MODEL NUMBER 3380-14

DRIVE

A	B	C	D	E	F	G	K	M	N	O	P
 19	 26	 31	 20	 36	 45	 25	 26	 15	 15	 99	 14
 20		 32		 20	 46	 46	 83		 94		 13
						 20					

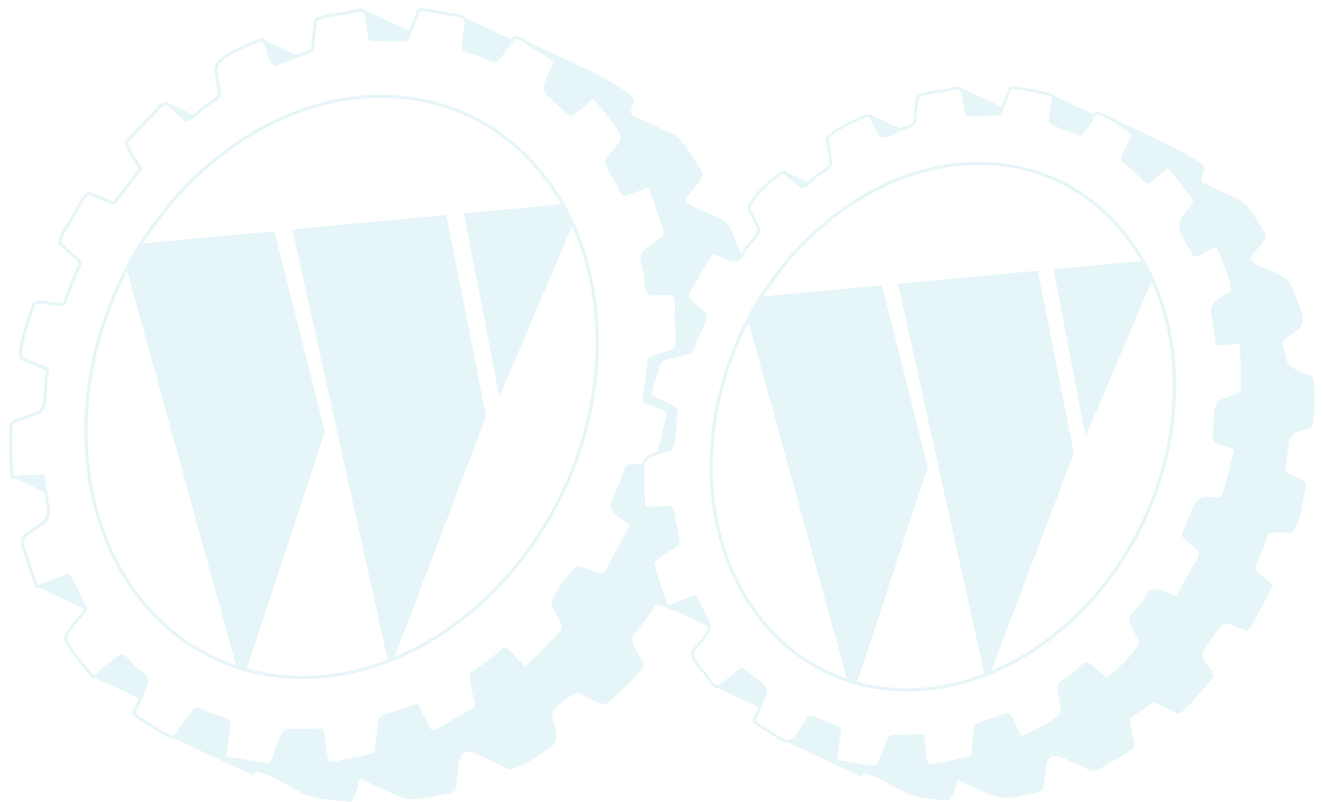

Ref #	Part Number	Qty	Description
13	10040500		LOCKWASHER
14	71070510		SCREW LT
15	17490620		SCREW
19	74760644		BOLT
20	73680600		SUB= 73690600
25	74760616		BOLT
26	17490512		SCREW
31	74760512		BOLT
32	73680500		SUB= 73690500
36	74760612		SUB= 74780612
45	17490612		SCREW
46	19131312		WASHER
94	11050600		LOCKWASHER
99	17030808		SUB= 17030814
	121120X		DECAL
	129057		SUB= 532129057

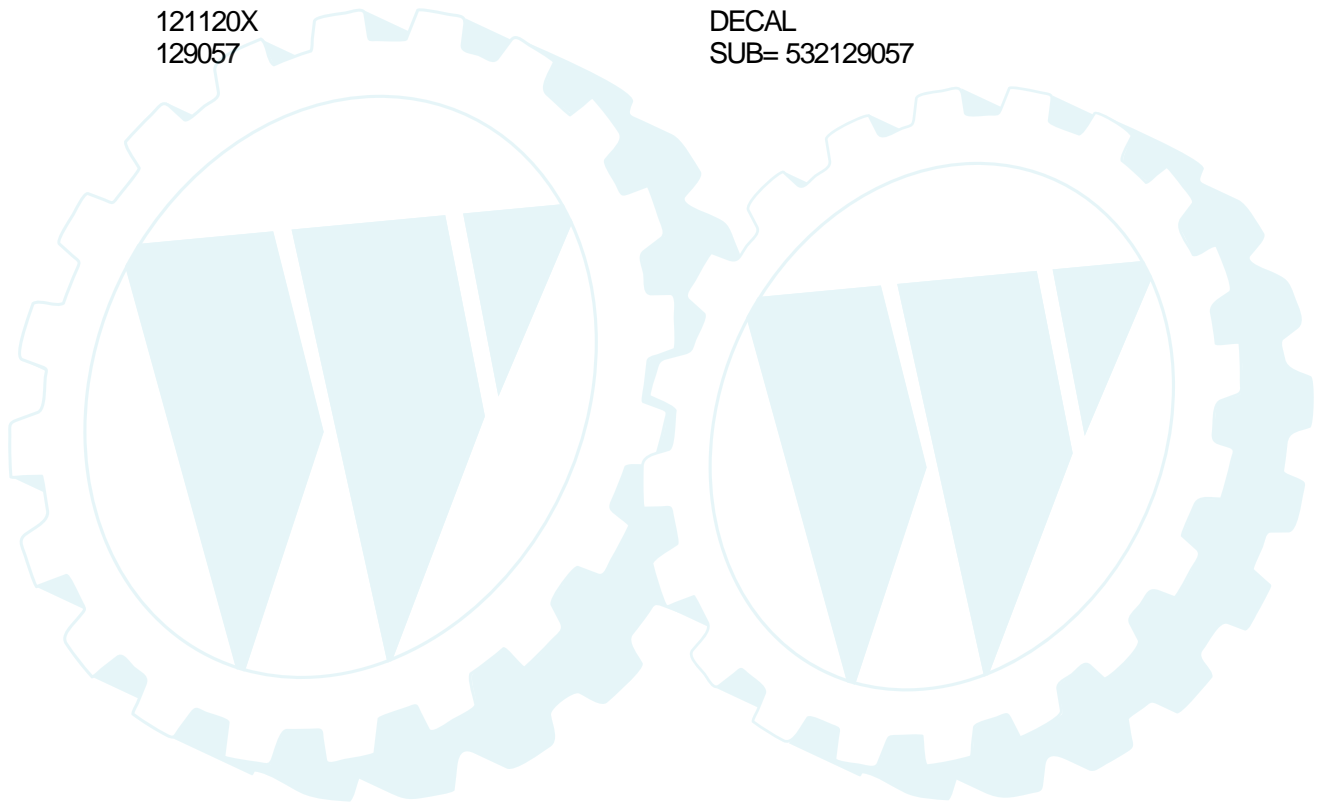

12.5 HP LAWN TRACTOR - MODEL NUMBER 3380-14

ELECTRICAL

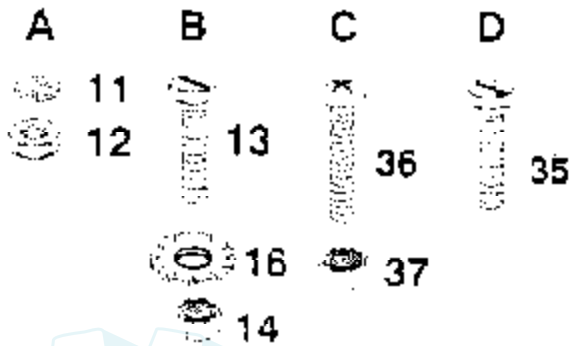

NOTE: All component dimensions given in U.S. inches
1 inch = 25.4 mm

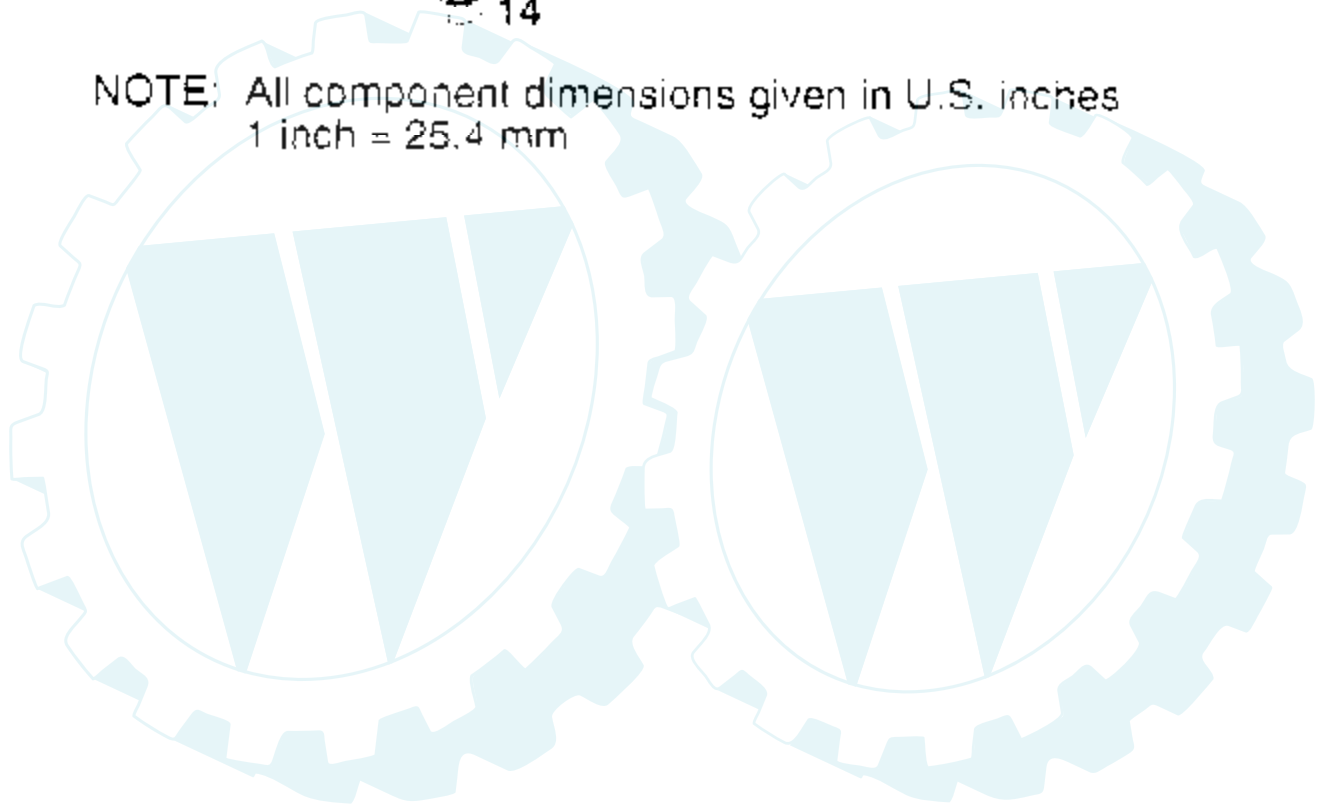

Ref #	Part Number	Qty	Description
11	10090400		SUB= 10040400
12	73350400		NUT
13	74780408		BOLT
14	73510400		NUT
16	11050400		LOCKWASHER
35	17021008		SCREW
36	74641008		SUB= 71031008
37	73951000		"NUT,KEPS"
	101539X		SHEET INSTR LT
	127991		MANUAL, REPAIR PARTS
	127903		NLA
	121549X		DECAL



12.5 HP LAWN TRACTOR - MODEL NUMBER 3380-14

38" MOWER

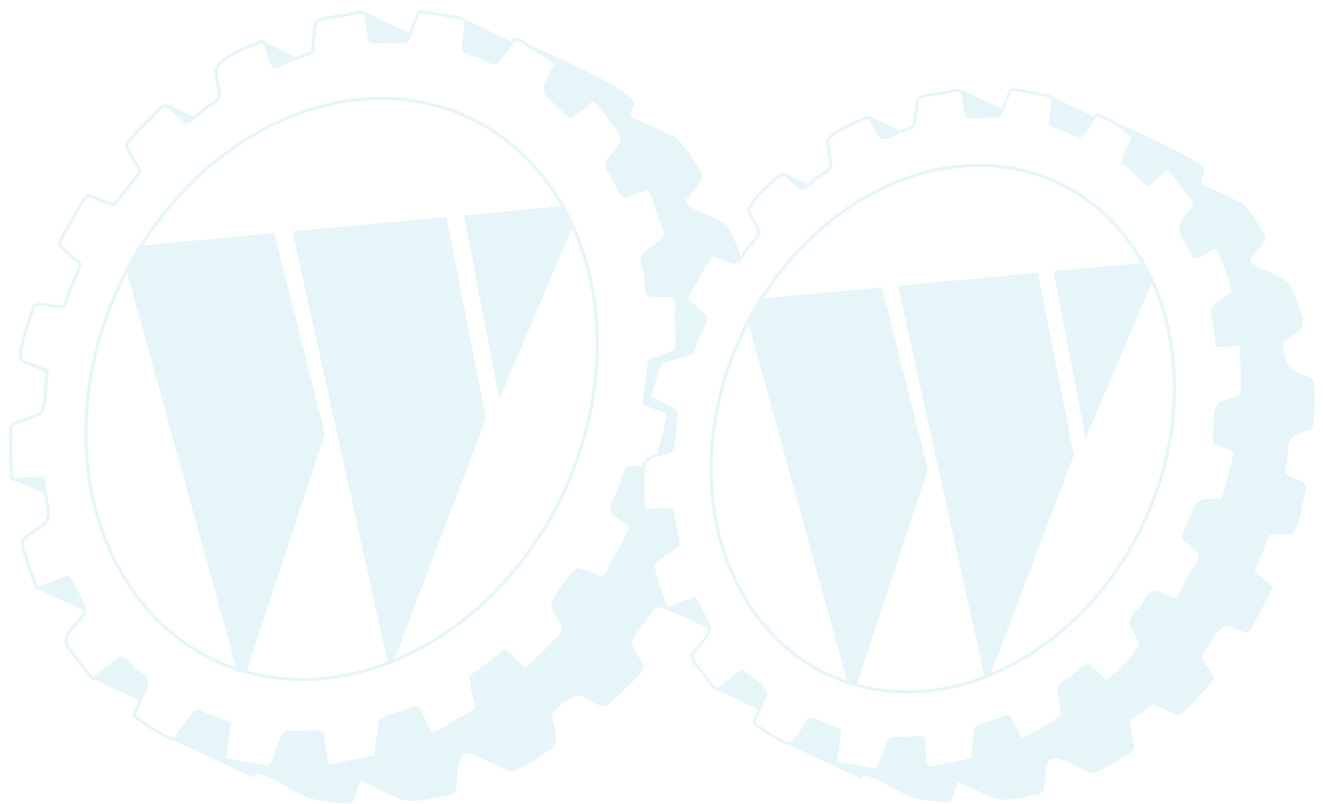
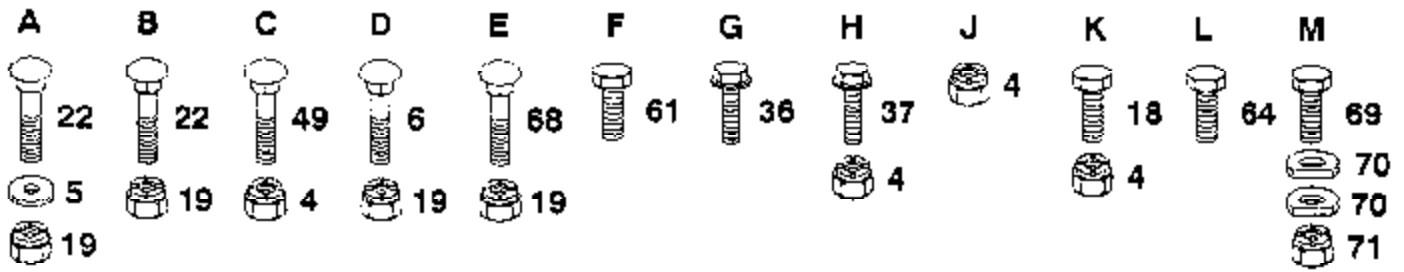



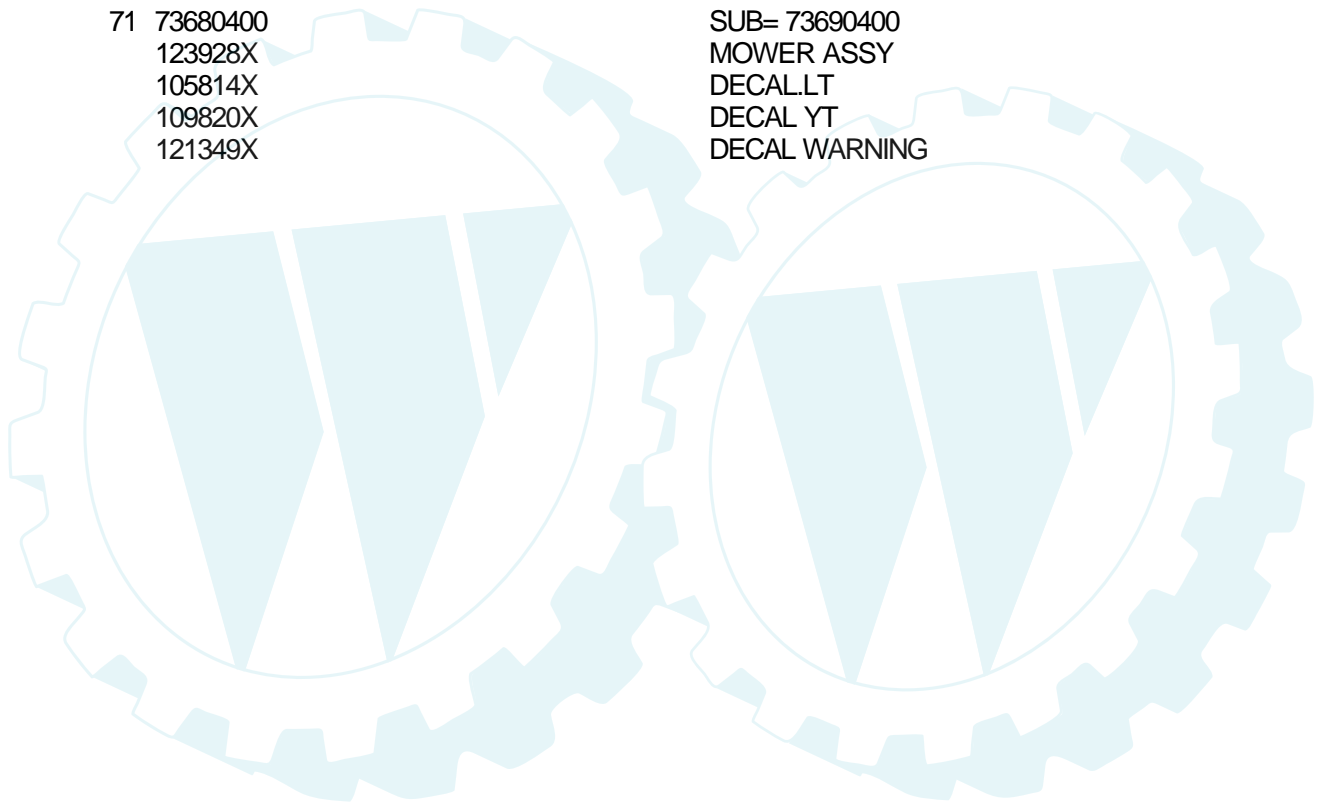





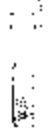











Ref #	Part Number	Qty	Description
4	73680600		SUB= 73690600
5	19111216		WASHER M
6	72140505		BOLT
18	74760612		SUB= 74780612
19	73680500		SUB= 73690500
22	72140506		BOLT
36	17490614		SCREW
37	17490620		SCREW
49	72140606		BOLT
61	74760688		BOLT
64	72140610		BOLT.3/8-14X1.25
68	72110506		SUB= 72270506
69	74760412		BOLT LT
70	109893X		WASHER T
71	73680400		SUB= 73690400
	123928X		MOWER ASSY
	105814X		DECAL.LT
	109820X		DECAL YT
	121349X		DECAL WARNING



12.5 HP LAWN TRACTOR - MODEL NUMBER 3380-14

ENCLOSURE

A	B	C	D	E	F	G	M	N	S	U
 2	 5	 10	 12	 10	 17	 21	 3	 50	 14	 62
	 6	 24		 9			 59	 47		
		 11		 11	 11			 11		 63

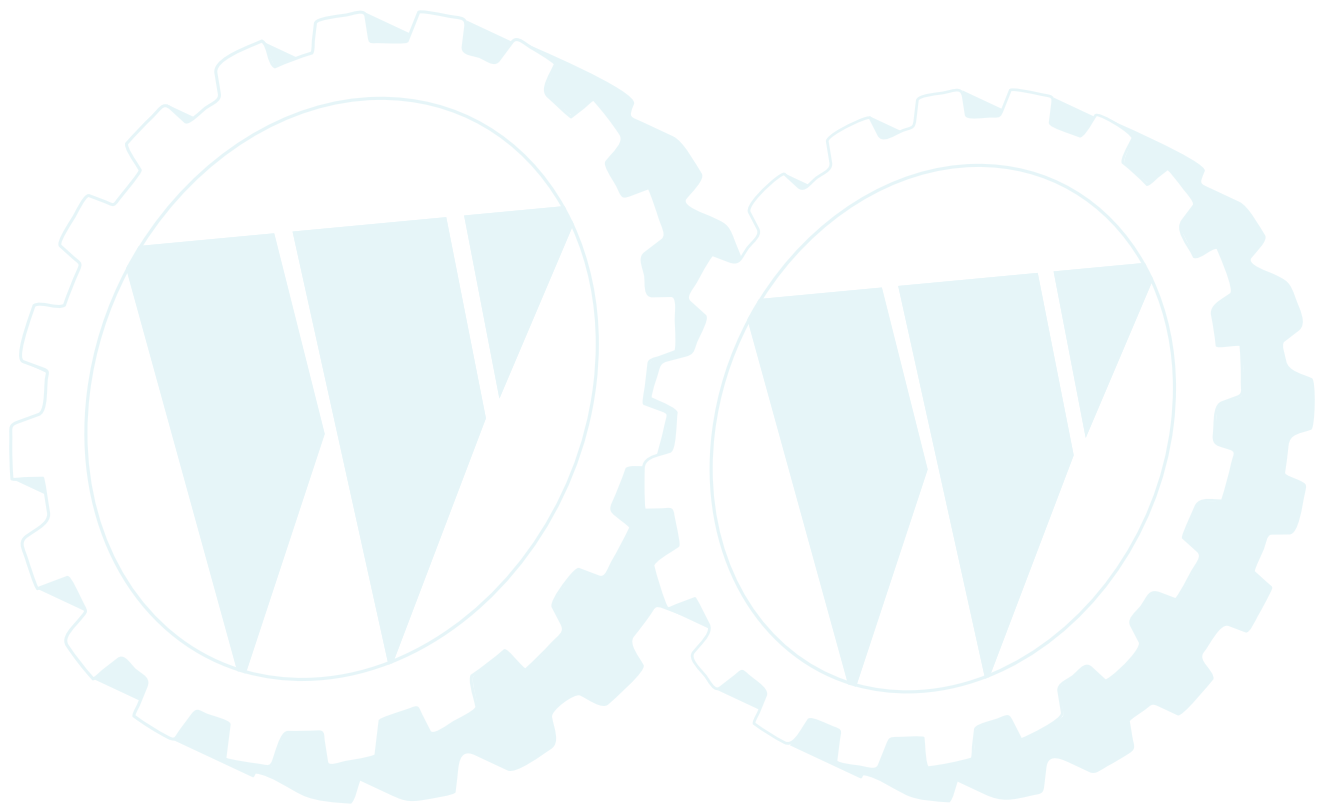

Ref #	Part Number	Qty	Description
2	17490612		SCREW
3	17490616		SCREW GTV
5	105529X		SUB= 139888
6	73680500		SUB= 73690500
9	19131312		WASHER
10	74760612		SUB= 74780612
11	73680600		SUB= 73690600
12	17490608		SCREW LT
14	127018X		"BOLT,SHOULDER"
17	72110606		BOLT
21	108067X		PAL NUT LT
24	19131210		WASHER
47	19132012		WASHER
50	74760616		BOLT
59	19131614		WASHER
62	72170410		BOLT
63	123976X		SUB= 73900400
	129685		DECAL, HOOD
	109199X		SUB= 146046
	129686		DECAL, HOOD

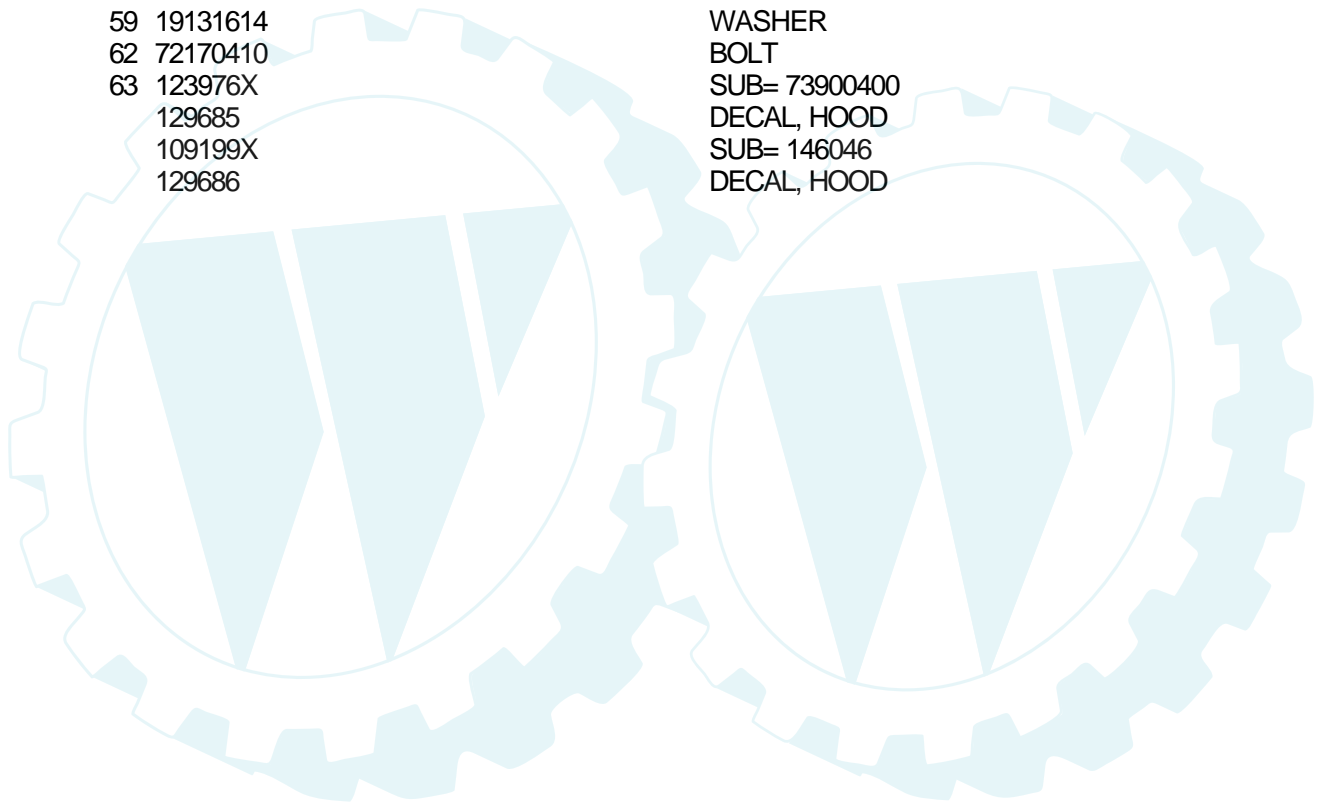

12.5 LAWN TRACTOR - MODEL NUMBER 3380-14

LIFT ADJUSTMENT

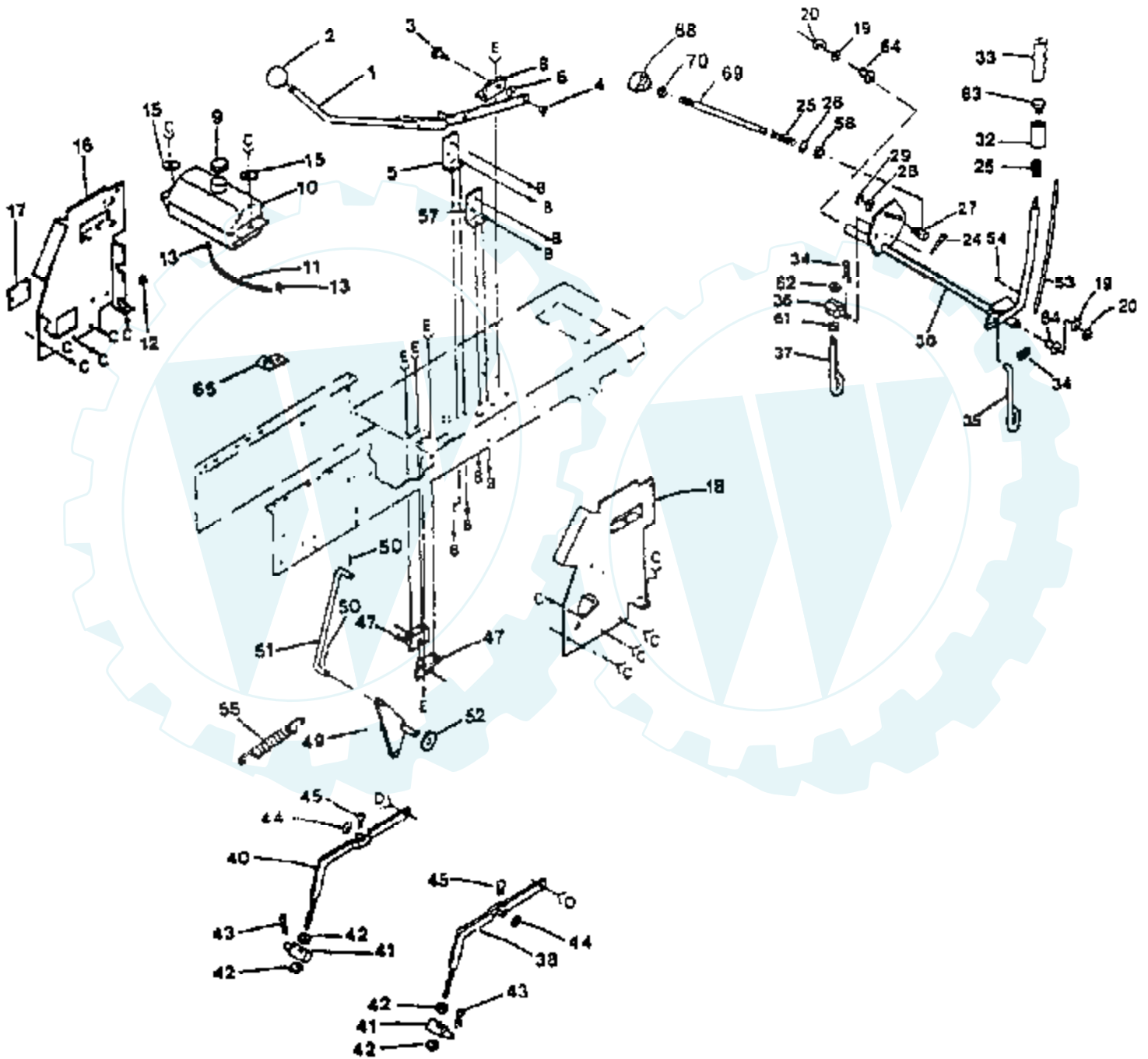

Ref #	Part Number	Qty	Description
1	124429X		SUB= 532124429
2	7803J		SUB= 106932X
3	106451X		"BOLT, SHOULDER LT"
4	73680600		SUB= 73690600
5	106452X		"BRACKET,SWITCH LT"
6	19171516		WASHER T
8	106447X		"SUP,LVR,CLUTCH LT"
9	123549X		SUB= 158990
10	109202X		TANK.FUEL.LT.
11	101335K		SUB= 8548R
12	124028X		SUB= 532124028
13	123487X		HOSE CLAMP
15	19091416		WASHER
16	122795X		PANEL DASH LH
17	121794X		COVER ACCESS
18	126276X		SUB= 155936
19	19211416		WASHER
20	12000002		SUB= 2225J
24	76020308		SUB= 3145
25	122512X		SUB= 532122512
26	19131016		WASHER
24	110810X		TRUNION LT
28	19151216		WASHER
29	12000037		KLIP RING
30	122507X		SUB= 145117
32	122364X		SUB= 125925X
33	109413X		GRIP
34	4939M		SUB= 85902
35	110029X		LIFT LINK LT
36	110447X		SUB= 132793
37	110448X		PIVOT PIN T
38	121598X		RH SUSP ARM ASM
40	121599X		LH SUSP ARM ASM
41	106308X		SUB= 130171
42	73220800		NUT
43	9135R		SPRING H
44	19171516		WASHER T
45	4921H		SPRING.RETAINER
47	106444X		"BRKT,BELLCRAN T"
49	109728X		"T, BELLCRANK"
50	76020412		COTTER PIN
51	124444X		SUB= 532124444
52	19131410		WASHER
53	122514X		SUB= 136973
54	105767X		PIN-GROOVE LT
55	124446X		SUB= 532124446
57	108236X		BRACKET LT
58	110807X		NUT T
61	73360700		NUT
62	73710700		NUT LOCK YTH
63	124526X		SUB= 125925X
64	120183X		NYLON BEARING
65	5320R		INSUL CLIP T
68	121891X		HDLE ADJ LIFT
69	110809X		SUB= 532126971
70	73350600		NUT

12.5 HP LAWN TRACTOR - MODEL NUMBER 3380-14

STEERING AND FRONT AXLE

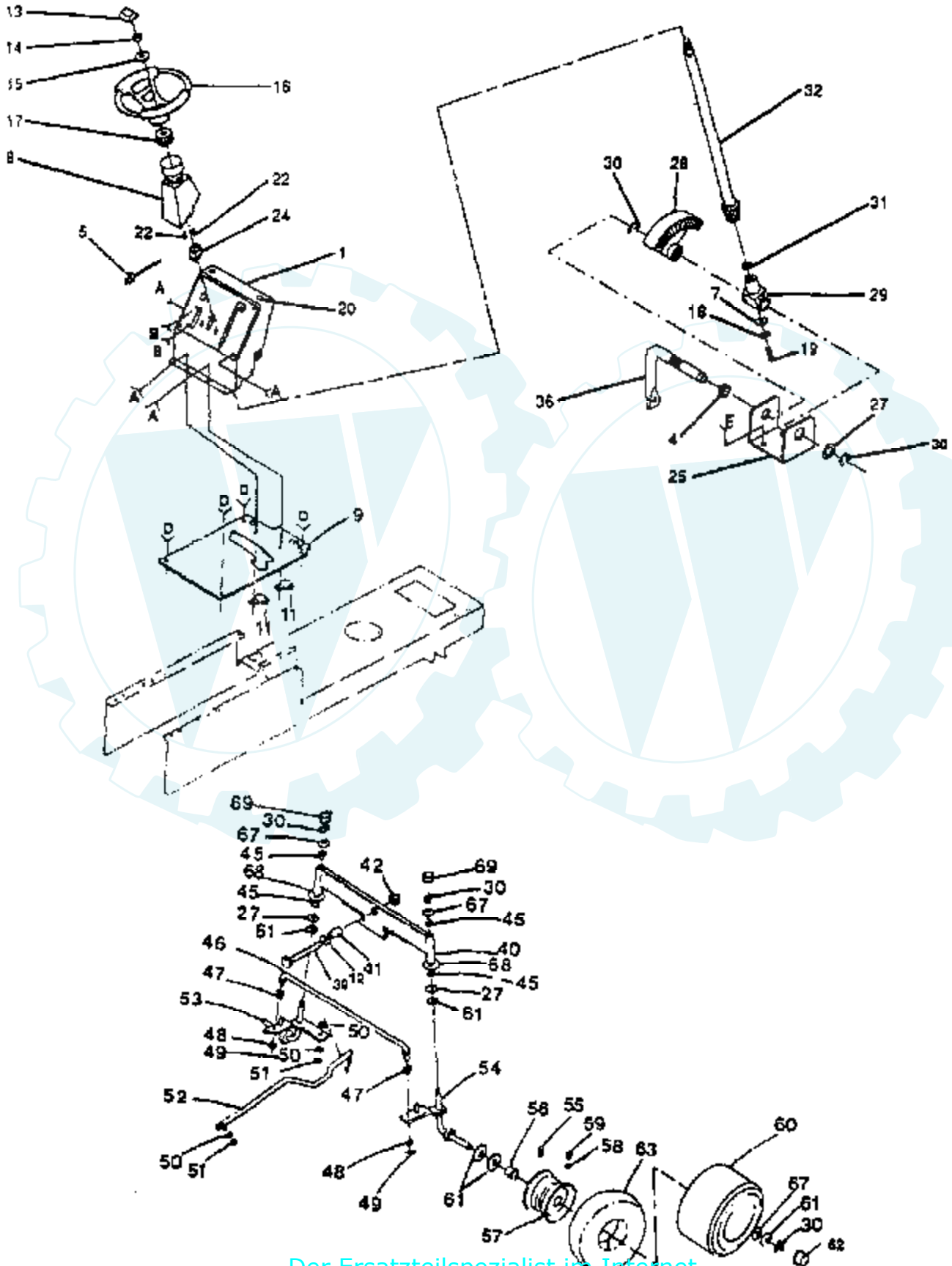

Ref #	Part Number	Qty	Description
1	123042X013		DASH
4	109816X		NYLINER T
5	129163		SUB= 132771
7	126684X		SUB= 532126684
8	124418X		"TUBE, STR SHAFT"
9	124649X012		SADDLE
11	2751R		CLIP T
12	19212010		WASHER
13	100710L		INSERT-WHEEL LT
14	73940800		SUB= 73360800
15	100712K		WASHER
16	100713N		SUB= 150547
17	100711L		ADAPTER LT
18	10040400		LOCKWASHER
19	71070410		"SCREW,SPECIAL"
20	124030X		SUB= 532126938
22	17431008		SUB= 98000165
24	124373X		"BUSHING,STEERING"
25	124036X		"BRKT,STEERING"
27	6266H		WASHER .T
28	124034X		SUB= 136874
29	124035X		SUPPORT.SHAFT
30	12000029		RING
31	57079		THRUST WASHER
32	128752		SHAFT WELD STR T
36	124033X		SUB= 156365
39	74761060		BOLT LT
40	105669X		SUB= 108075X
42	73601000		SUB= 73901000
45	3366R		COL. SRTG. BEAR.
46	105715X		ROD-TIE LT
47	120754X		SUB= 126847X
48	19131416		WASHER
49	76020412		COTTER PIN
50	10040600		LOCKWASHER
51	73610600		SUB= 7810H
52	128122		SUB= 532130468
53	105656X		SPINDLE-LH LT
54	105654X		SUB= 130524
55	278H		FITTING LT
56	9040H		"FLANGE, BEARING"
57	106732X361		SUB= 106732X417
58	59192		VALVE CAP
59	65139		VALVE STEM LT
60	106222X		SUB= 122073X
61	121749X		WASHER
62	104757X		HUB CAP
63	59904		TUBE.5.3/4.5/6
67	121748X		WASHER
68	19272016		WASHER
69	121232X		CAP
	127026		DECAL, INSERT
	129493		DECAL, STEERING WHEEL
	109821X		SUB= 138956

12.5 HP LAWN TRACTOR - MODEL NUMBER 3380-14 TRANSAXLE FOOTE-MODEL NUMBER 4360-7

TRANSAXLE

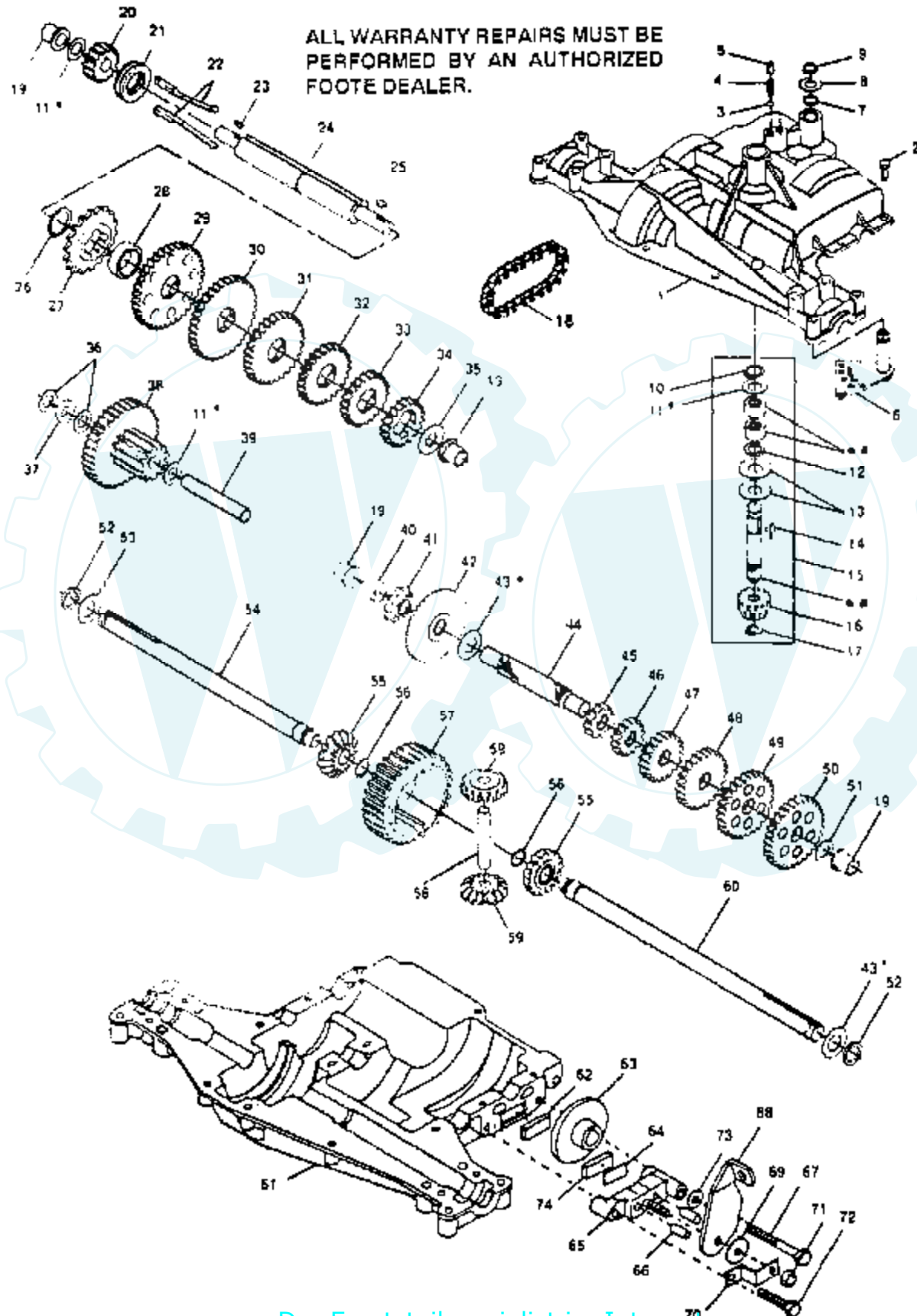

Ref #	Part Number	Qty	Description
1	3865		HOUSING UPPER
2	1919		SCREW
3	1151		BALL DETENT
4	3626		SPRING, DETENT
5	3623		SCREW, SET
6	4336		ASSY SHIFTER
7	3884		O-RING
8	3885		WASHER PLAIN
8	3886		WASHER PLAIN
8	3887		WASHER PLAIN
8	3888		WASHER PLAIN
8	3889		WASHER PLAIN
8	3121		WASHER PLAIN
8	3890		WASHER PLAIN
9	1100		RING RETAINING
10	1099		RING RETAINING
11	1959		WASHER PLAIN
11	1441		WASHER PLAIN
11	1423		WASHER, PLAIN .632 X 1.00 X .026
11	1082		WASHER PLAIN
11	1424		WASHER PLAIN
11	1068		WASHER PLAIN
11	1425		WASHER PLAIN
11	1358		WASHER PLAIN
11	1145		WASHER, PLAIN .632 X 1.00 X .060
11	1319		WASHER PLAIN
12	3312		O-RING
13	3876		WASHER, PLAIN .632 X 1.38 X .046
14	1374		KEY WOODRUFF #9
15	4134		ASSY KIT INPUT SHAFT
16	3590		PINION, BEVEL, 14 TEETH
17	3624		RING, RETAINING
18	3625		CHAIN, 24 PITCHES
19	1542		BEARING, FLANGE
20	3773		GEAR SPUR, 14 TEETH
21	3631		COLLAR CLUTCH
22	3828		KEY CLUTCH
23	1369		KEY WOODRUFF #3
24	3883		SHAFT INTERMEDIATE
25	1375		KEY, WOODRUFF, #61
26	3627		RING, RETAINING
27	3830		SPROCKET, 18 TEETH
28	3841		SPACER
29	3786		GEAR, SPUR, 37 TEETH
30	3785		GEAR, SPUR, 35 TEETH
31	3867		GEAR, SPUR, 30 TEETH
32	3783		GEAR, SPUR, 25 TEETH
33	3869		GEAR, SPUR, 22 TEETH
34	3741		GEAR SPUR
35	3628		WASHER, PLAIN .640 X 1.37 X .061
36	1423		WASHER, PLAIN .632 X 1.00 X .026
37	3422		SPACER .630 X 1.00 X .169
38	4286		ASSY GEAR COMB 12&35 TEETH
39	3877		SHAFT IDLER
40	3901		SPACER .635 X .875 X .755
41	3645		SPROCKET, 9 TEETH
42	3853		GEAR BEVEL 42 TEETH
43	3749		WASHER PLAIN

Ref #	Part Number	Qty	Description
43	3652		WASHER PLAIN
43	3693		WASHER PLAIN
43	3653		WASHER PLAIN
43	3408		WASHER PLAIN
43	3732		WASHER PLAIN
43	3184		WASHER, PLAIN .758 X 1.25 X .031
43	3733		WASHER PLAIN
43	3198		WASHER PLAIN
43	3734		WASHER PLAIN
43	3735		WASHER PLAIN
43	3736		WASHER PLAIN
43	3180		WASHER PLAIN
44	3882		SHAFT, DRIVE
45	3646		GEAR, SPUR, 12 TEETH
46	3707		GEAR SPUR, 15 TEETH
47	3866		GEAR, SPUR, 20 TEETH
48	3719		GEAR, SPUR, 25 TEETH
49	3868		GEAR, SPUR, 28 TEETH
50	3683		GEAR, SPUR, 31 TEETH
51	1145		WASHER, PLAIN .632 X 1.00 X .060
52	3191		SEAL FELT
53	3180		WASHER PLAIN
54	3880		AXLE LEFT HAND
55	3780		GEAR, MITER, 15 TEETH
56	3656		RING, RETAINING
57	3839		GEAR, SPUR, 32 TEETH
58	3919		SHAFT, CROSS
59	3781		GEAR, MITER, 15 TEETH
60	3881		AXLE, R.H.
61	3864		HOUSING LOWER
62	3920		PUCK, FRICTION
63	3276		DISC, BRAKE
64	3758		SPACER
65	3916		JAW, BRAKE
66	3843		PIN, DOWEL
67	3915		SCREW TAPPING
68	3768		LEVER, ACTUATING
69	3760		WASHER, PLAIN .321 X 1.00 X .055
70	3917		BRACKET, ANTI-ROTATION
71	3847		LOCKNUT 5/16-24
72	3724		SCREW TAPPING
73	3906		WASHER PLAIN
74	3907		PUCK, FRICTION
75	4300		GREASE